

Photometric Test Report



AstraWash19Pix

19x40W RGBW moving wash light with 4°-54°
zoom, pixel control and pixel ring

CONTENTS

Table of contents	2
Testing process	4
Color preset Full on	
Beam angle Max Zoom	5
Beam angle Med Zoom	8
Beam angle Min Zoom	11
Color preset Red	
Beam angle Max Zoom	14
Beam angle Med Zoom	17
Beam angle Min Zoom	20
Color preset Green	
Beam angle Max Zoom	23
Beam angle Med Zoom	26
Beam angle Min Zoom	29
Color preset Blue	
Beam angle Max Zoom	32
Beam angle Med Zoom	35
Beam angle Min Zoom	38
Color preset White	
Beam angle Max Zoom	41
Beam angle Med Zoom	44
Beam angle Min Zoom	47
Color preset 2800K	
Beam angle Max Zoom	50
Beam angle Med Zoom	55
Beam angle Min Zoom	60
Color preset 3200K	
Beam angle Max Zoom	65
Beam angle Med Zoom	70
Beam angle Min zoom	75

Color temperature 4000K

Beam angle Max Zoom 80

Beam angle Med Zoom 85

Beam angle Min Zoom 90

Color temperature 5600K

Beam angle Max Zoom 95

Beam angle Med Zoom 100

Beam angle Min Zoom 105

Color temperature 6000K

Beam angle Max Zoom 110

Beam angle Med Zoom 115

Beam angle Min Zoom 120

TESTING PROCESS

Prolights has its own optical testing laboratory in order to provide accurate photometric reports for its lighting products. The testing laboratory contains certain variety of precise lighting measurement systems that ensure an optimal reading of all the characteristic parameters of the lighting devices. All measurements are made at a controlled room temperature of 25°C without any external light sources. This photometric report is obtained through the data measured by a high precision measurement system and analyzed by a dedicate software.

Prolights measurement instrument

Prolights measurement instrument is a complete measurement system for any light source. It's equipped with two-axis goniometer, that enables to measure the full 3D distribution field of the light source. This instrument measures the light intensity, the beam angle and the most significative colors parameters, like color temperature, spectral distribution, CRI, CQS, TM-30 with a very high accuracy rate.

Please Note: All measurements are made with light source at operating temperature. Before starting the measurement, the instrument analyzes the process of the light source during the heating phase. The measuring process of all the parameters begins only when the light emission is stable, that is with a variation of less than 0.5% in a 15 minutes time frame.

Prolights measurement software

The software provides user friendly interface for the operator who does the measurements, and it also analyzes and processes all the collected data by the instrument. With this software it is possible to see the measured data in real-time and it is possible to examine all the measured data and graphics afterwards as well. All information is collected in a specific Prolights template, and the software creates also IES and LDT files, which are widely used to transfer the photometric data, and to develop lighting system.

Additionally, the fixtures are rechecked using various hand-held instruments like Sekonic C-700 and Gossen Mavospec Base, this is done to ensure, that the data in the photometric report are as accurate as possible.



Total lumen output:

10143 lm

Peak candela output:

29348 cd

PRODUCT NAME:

ASTRAWASH19PIX

MEASUREMENT CONDITIONS:

Beam angle:

Max Zoom

Target:

Full On Cal. Off

Operator:

Paolo Carvone

Date and time:

18/02/2021 09:43:19

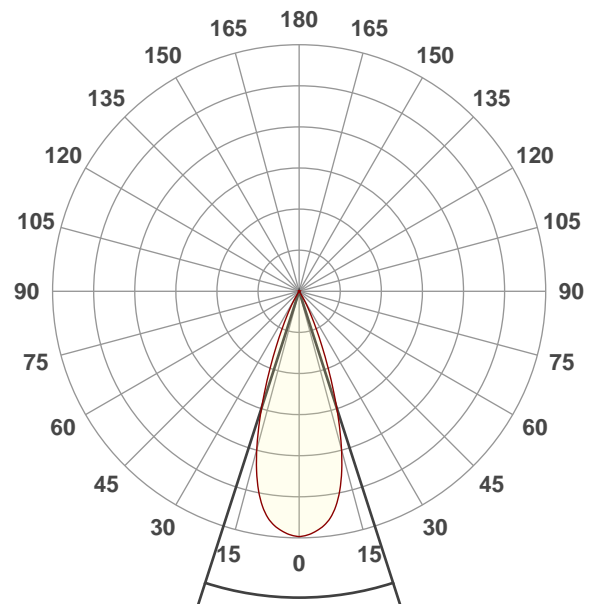

Beam angle 50%: 35,7°

Field angle 10%: 53,9°

Cut off angle 2.5%: 62,2°

Spectra

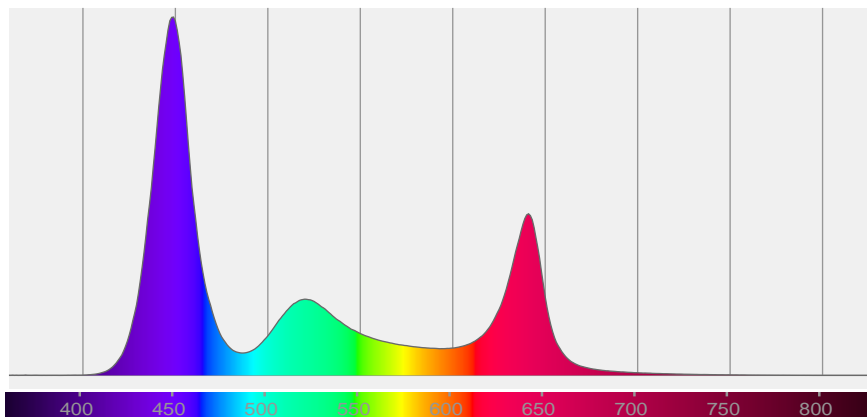

BEAM DETAILS



Beam angle 50%	Field angle 10%	Cut off angle 2,5%	Intensity ratio in 120° cone	Intensity ratio in 90° cone
35,7°	53,9°	62,2°	100,0%	100,0%

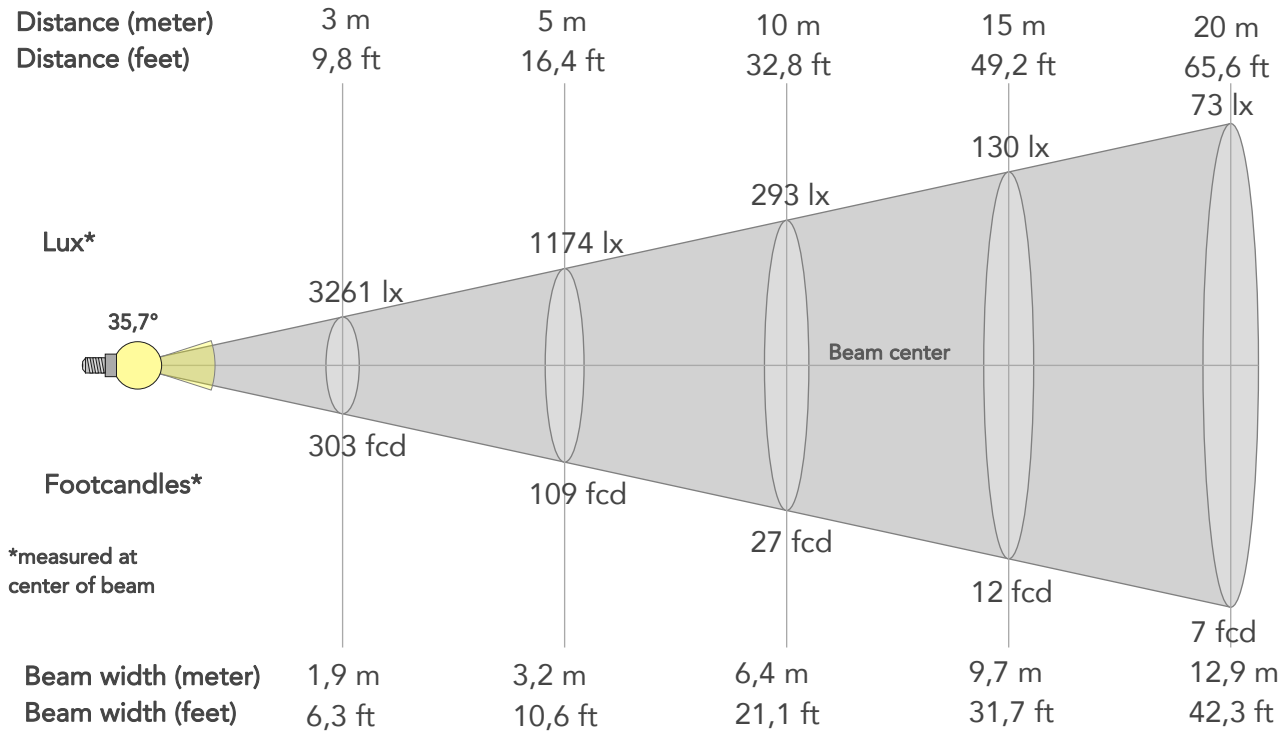

BEAM INTENSITIES AND WIDTHS

Distance	1m	2m	3m	4m	5m	7,5m	10m	15m	20m	25m	30m	40m	50m
Distance	3,3ft	6,6ft	9,8ft	13,1ft	16,4ft	24,6ft	32,8ft	49,2ft	65,6ft	82ft	98,4ft	131,2ft	164ft
Lux	29348lx	7337lx	3261lx	1834lx	1174lx	522lx	293lx	130lx	73lx	47lx	33lx	18lx	12lx
Footcand.	2726fcd	682fcd	303fcd	170fcd	109fcd	48fcd	27fcd	12fcd	7fcd	4fcd	3fcd	2fcd	1fcd
Beam wid.	0,6m	1,3m	1,9m	2,6m	3,2m	4,8m	6,4m	9,7m	12,9m	16,1m	19,3m	25,8m	32,2m
Beam wid.	2,1ft	4,3ft	6,3ft	8,4ft	10,6ft	15,9ft	21,1ft	31,7ft	42,3ft	52,9ft	63,4ft	84,6ft	105,7ft

LINEAR DISTRIBUTION DIAGRAM

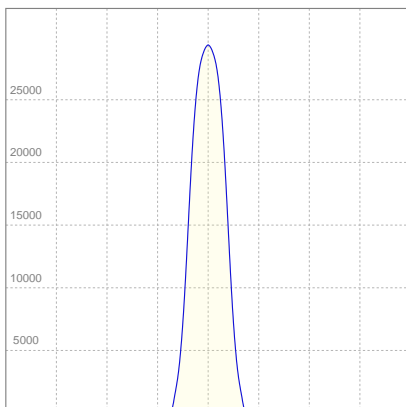

ELECTRICAL SPECIFICATIONS

Input voltage	Input current	Input power	Effeciency
220V	2,92A	611,3W	17lm/W

Power FC
0,95

ISO CANDELA DIAGRAM

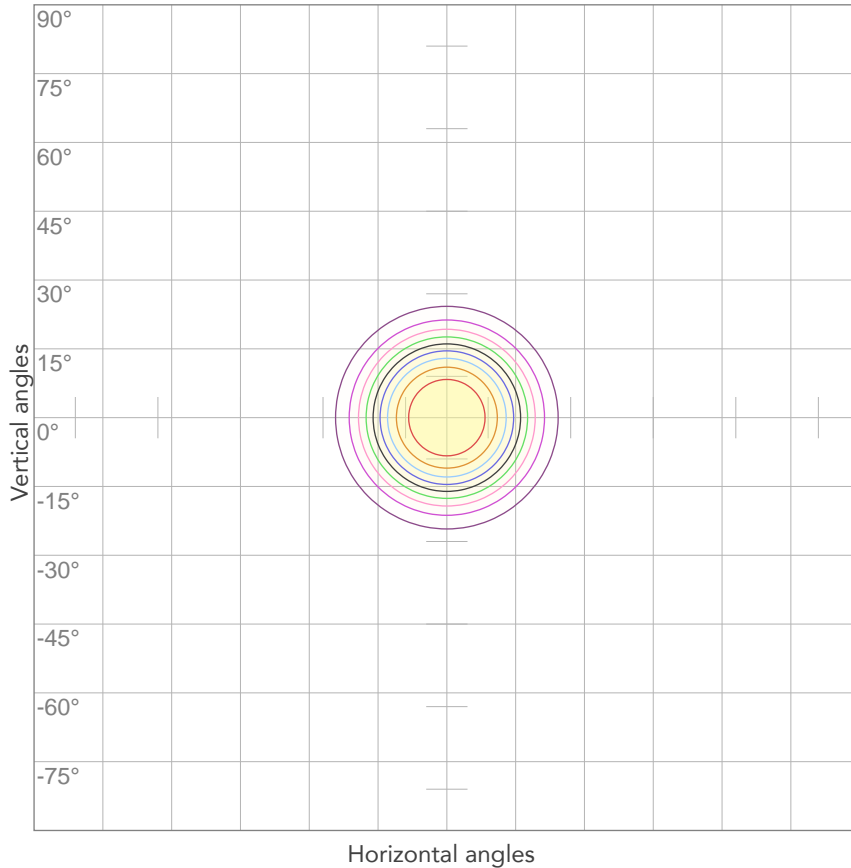

10%	2935 cd
20%	5870 cd
30%	8804 cd
40%	11739 cd
50%	14674 cd
60%	17609 cd
70%	20543 cd
80%	23478 cd

Conditions:

Number of c-planes: 2

Candela at center: 29348 cd

ISO LUX DIAGRAM

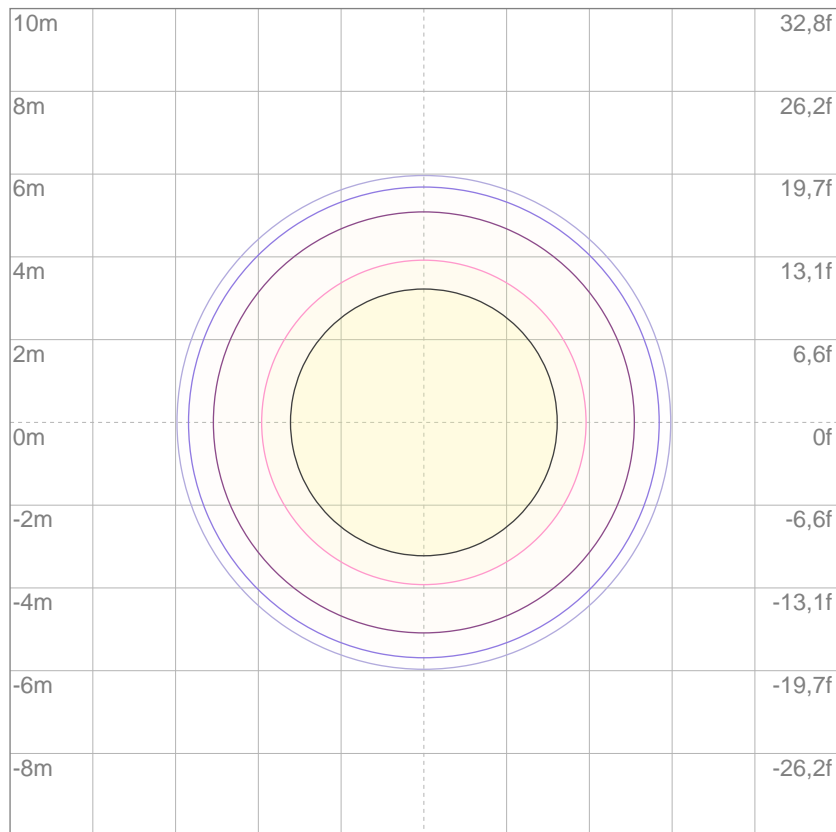

Mounting height: 10 meters (33 feet)

3%	8,80 lx
5%	14,7 lx
10%	29,3 lx
30%	88,0 lx
50%	147 lx

Conditions:

Number of c-planes: 2

Lux at center: 293 lx

Lux distribution on a surface when lamp is mounted at 10 meters from the surface.



Total lumen output:

4750 lm

Peak candela output:

61172 cd

PRODUCT NAME:

ASTRAWASH19PIX

MEASUREMENT CONDITIONS:

Beam angle:

Med Zoom

Target:

Full On Cal. Off

Operator:

Paolo Carvone

Date and time:

15/02/2021 12:48:17

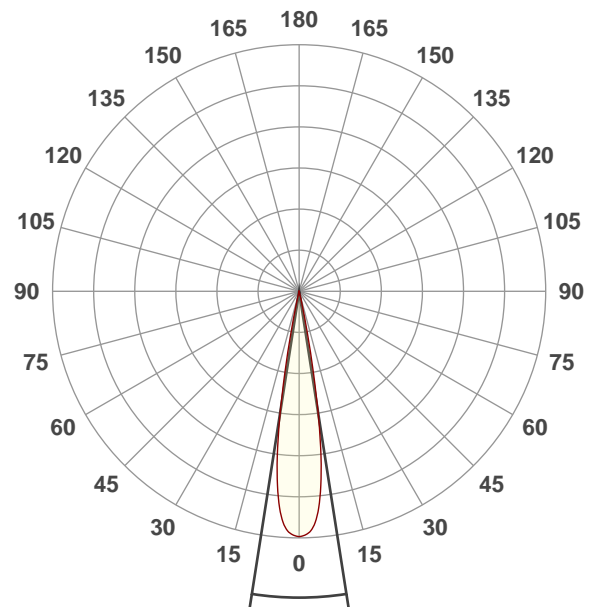

Beam angle 50%: 17,8°

Field angle 10%: 23,8°

Cut off angle 2.5%: 26,3°

Spectra

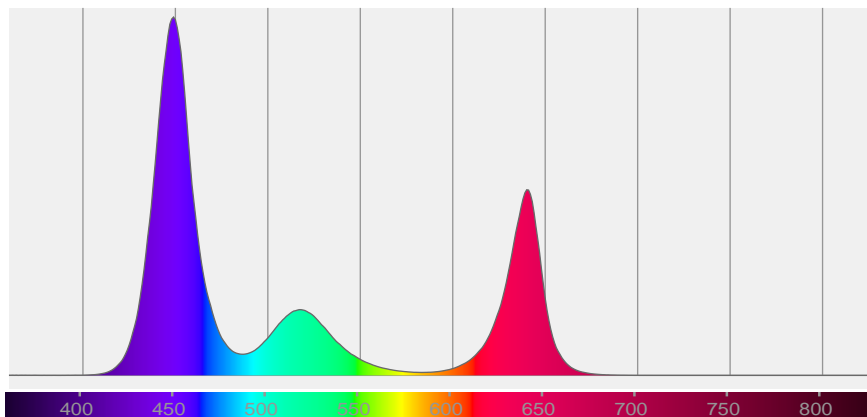

BEAM DETAILS



Beam angle 50%	Field angle 10%	Cut off angle 2,5%	Intensity ratio in 120° cone	Intensity ratio in 90° cone
17,8°	23,8°	26,3°	99,9%	99,9%

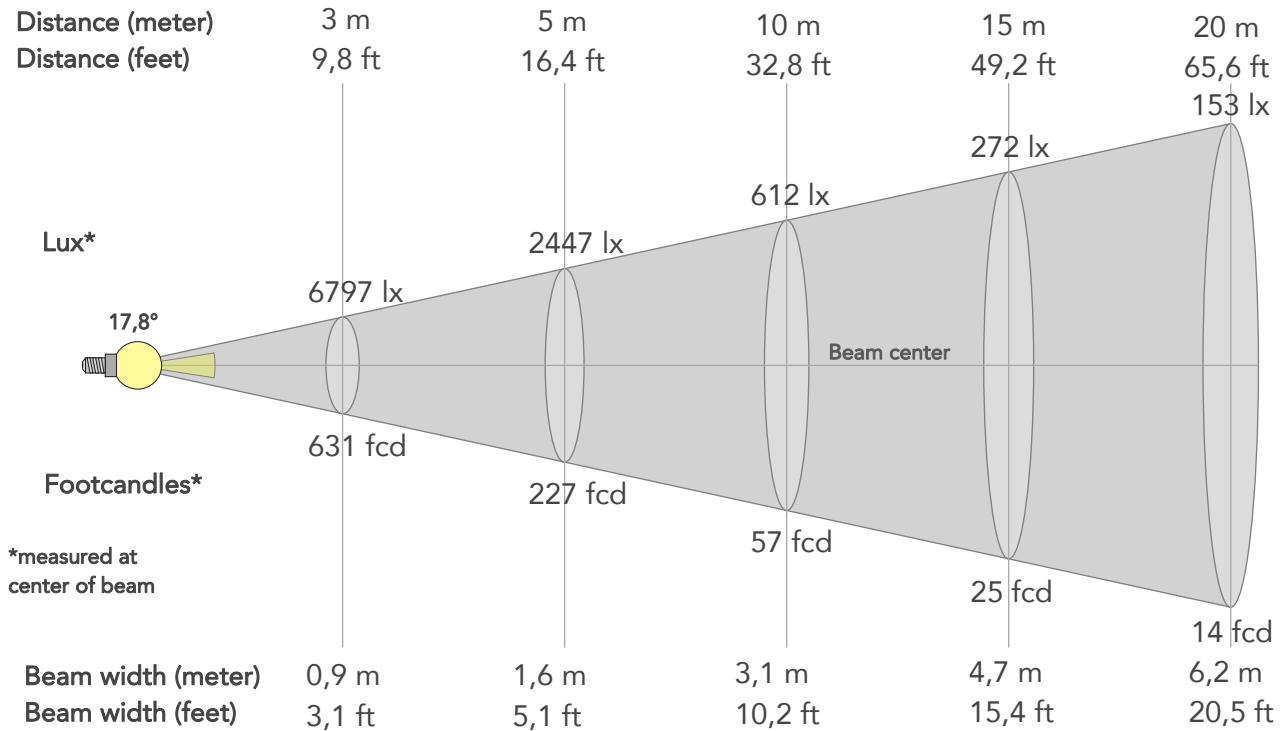

BEAM INTENSITIES AND WIDTHS

Distance	1m	2m	3m	4m	5m	7,5m	10m	15m	20m	25m	30m	40m	50m
Distance	3,3ft	6,6ft	9,8ft	13,1ft	16,4ft	24,6ft	32,8ft	49,2ft	65,6ft	82ft	98,4ft	131,2ft	164ft
Lux	61172lx	15293lx	6797lx	3823lx	2447lx	1087lx	612lx	272lx	153lx	98lx	68lx	38lx	24lx
Footcand.	5683fcd	1421fcd	631fcd	355fcd	227fcd	101fcd	57fcd	25fcd	14fcd	9fcd	6fcd	4fcd	2fcd
Beam wid.	0,3m	0,6m	0,9m	1,2m	1,6m	2,3m	3,1m	4,7m	6,2m	7,8m	9,4m	12,5m	15,6m
Beam wid.	1ft	2,1ft	3,1ft	4,1ft	5,1ft	7,7ft	10,2ft	15,4ft	20,5ft	25,6ft	30,7ft	41ft	51,2ft

LINEAR DISTRIBUTION DIAGRAM

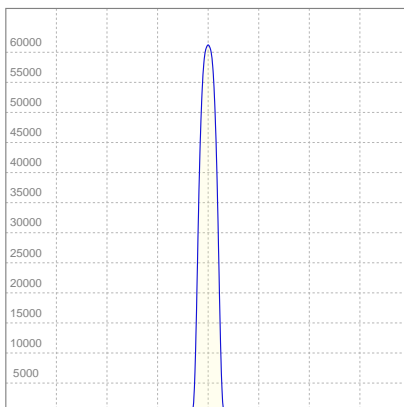

ELECTRICAL SPECIFICATIONS

Input voltage	Input current	Input power	Effeciency
222V	2,28A	481,8W	10lm/W

Power FC
0,95

ISO CANDELA DIAGRAM

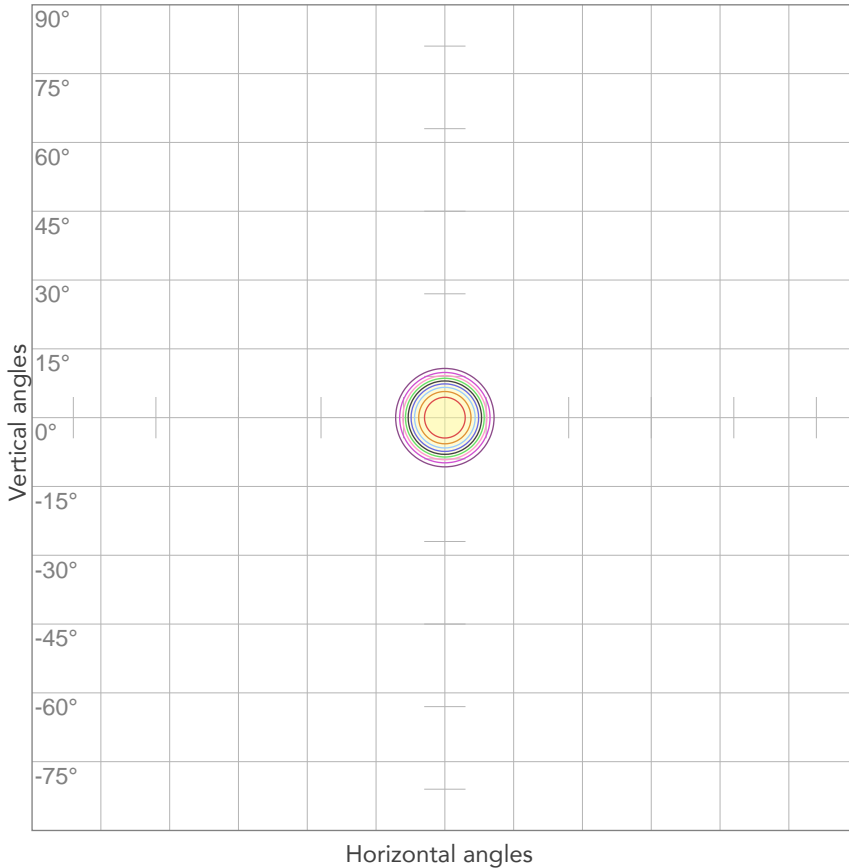

10%	6117 cd
20%	12234 cd
30%	18351 cd
40%	24469 cd
50%	30586 cd
60%	36703 cd
70%	42820 cd
80%	48937 cd

Conditions:

Number of c-planes: 2

Candela at center: 61172 cd

ISO LUX DIAGRAM

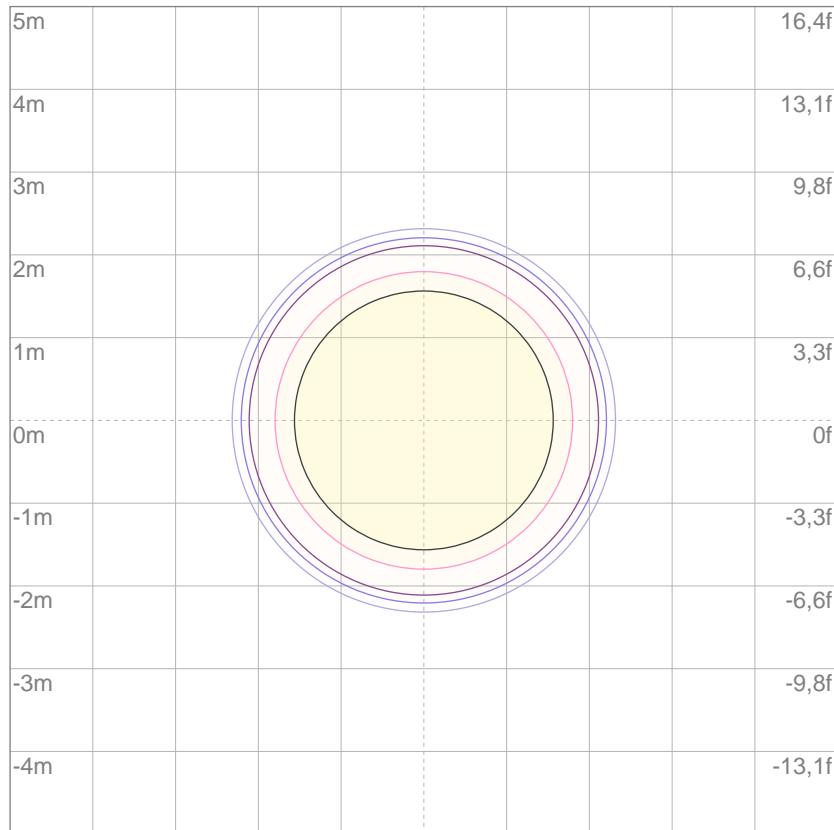

3%	18,4 lx
5%	30,6 lx
10%	61,2 lx
30%	184 lx
50%	306 lx

Conditions:

Number of c-planes: 2

Lux at center: 612 lx

Lux distribution on a surface when lamp is mounted at 10 meters from the surface.

Mounting height: 10 meters (33 feet)



Total lumen output:

5505 lm

Peak candela output:

1133310 cd

PRODUCT NAME:

ASTRAWASH19PIX

MEASUREMENT CONDITIONS:

Beam angle:

Min Zoom

Target:

Full On Cal. Off

Operator:

Paolo Carvone

Date and time:

15/02/2021 10:47:27

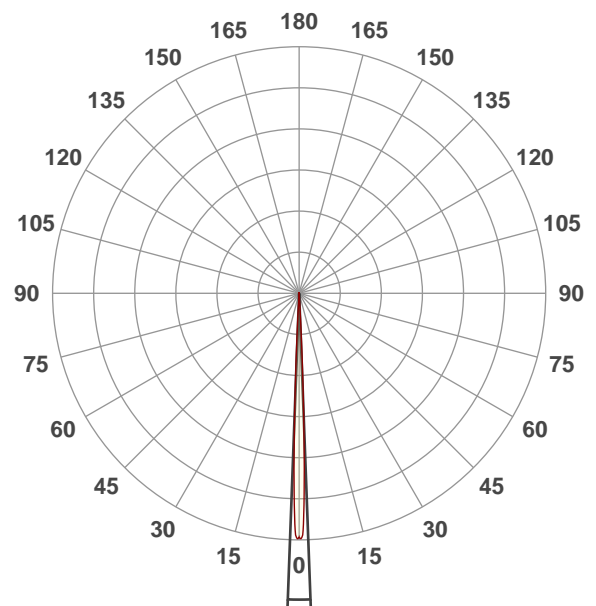

Beam angle 50%: 4,2°

Field angle 10%: 6,3°

Cut off angle 2.5%: 7,1°

Spectra

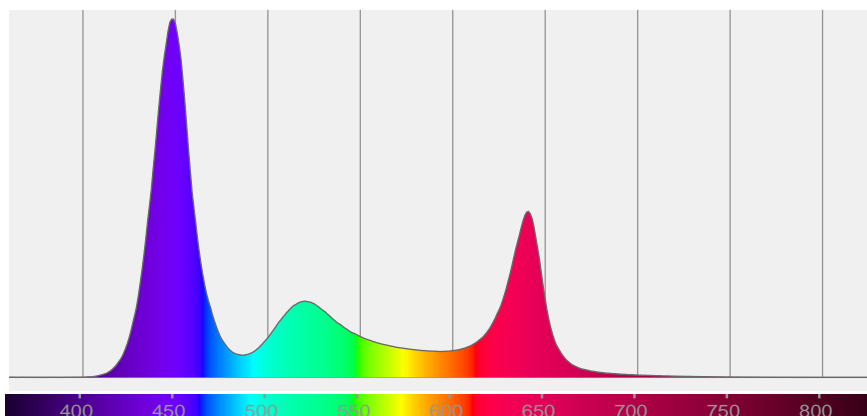

BEAM DETAILS



Beam angle 50%	Field angle 10%	Cut off angle 2,5%	Intensity ratio in 120° cone	Intensity ratio in 90° cone
4,2°	6,3°	7,1°	100,0%	100,0%

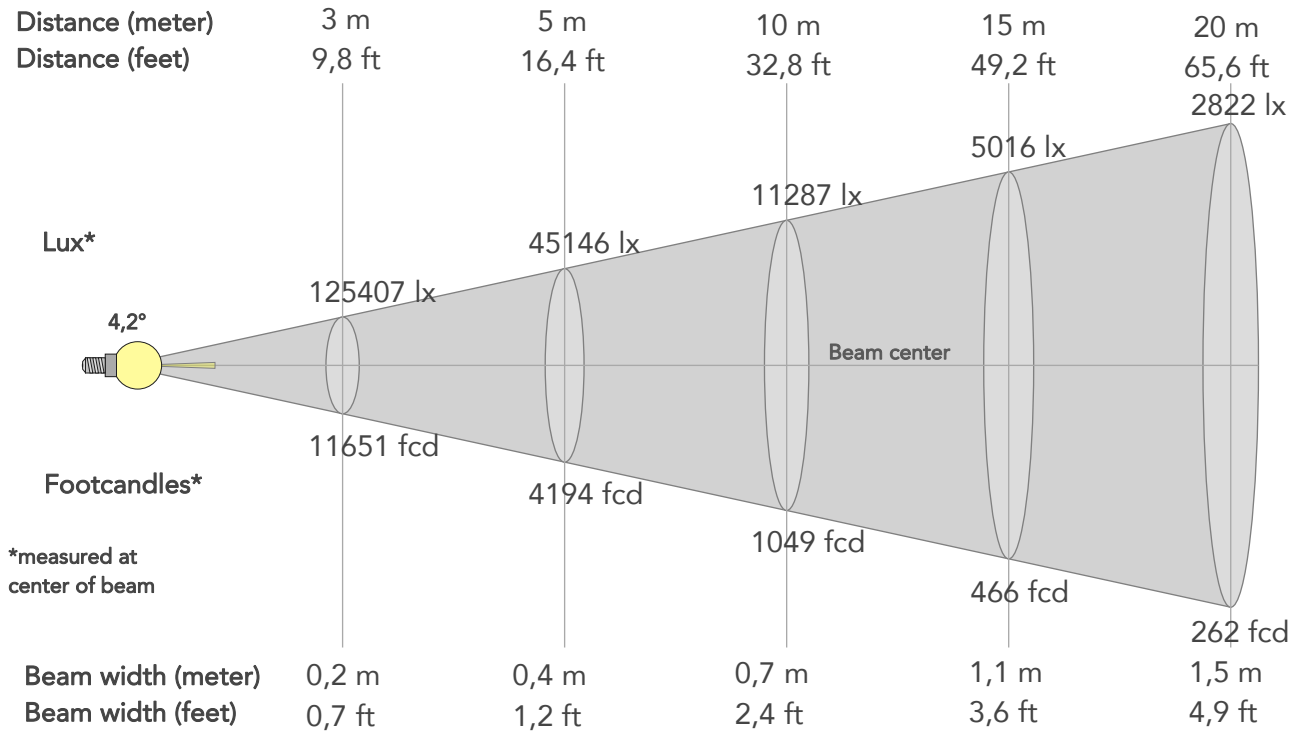

BEAM INTENSITIES AND WIDTHS

Distance	1m	2m	3m	4m	5m	7,5m	10m	15m	20m	25m	30m	40m	50m
Distance	3,3ft	6,6ft	9,8ft	13,1ft	16,4ft	24,6ft	32,8ft	49,2ft	65,6ft	82ft	98,4ft	131,2ft	164ft
Lux	1128662lx	282166lx	125407lx	70541lx	45146lx	20065lx	11287lx	5016lx	2822lx	1806lx	1254lx	705lx	451lx
Footcand.	104856fcd	26214fcd	11651fcd	6554fcd	4194fcd	1864fcd	1049fcd	466fcd	262fcd	168fcd	117fcd	66fcd	42fcd
Beam wid.	0,1m	0,1m	0,2m	0,3m	0,4m	0,6m	0,7m	1,1m	1,5m	1,9m	2,2m	3m	3,7m
Beam wid.	0,2ft	0,5ft	0,7ft	1ft	1,2ft	1,8ft	2,4ft	3,6ft	4,9ft	6,1ft	7,3ft	9,7ft	12,2ft

LINEAR DISTRIBUTION DIAGRAM

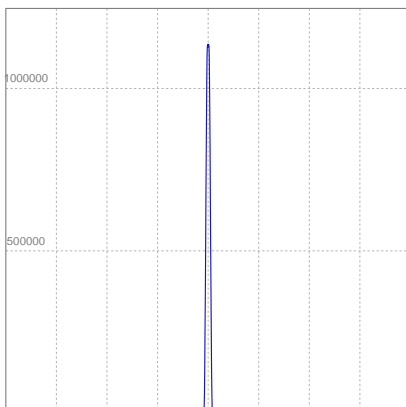

ELECTRICAL SPECIFICATIONS

Input voltage	Input current	Input power	Effeciency
221V	2,91A	610W	9lm/W

Power FC
0,95

ISO CANDELA DIAGRAM

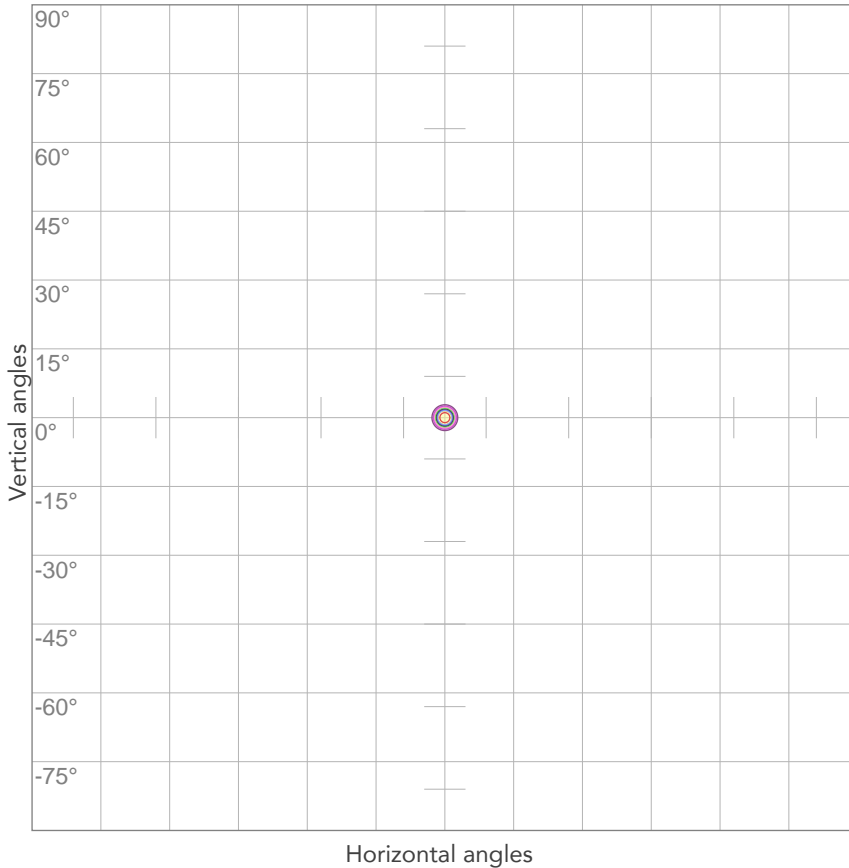

10%	112866 cd
20%	225732 cd
30%	338599 cd
40%	451465 cd
50%	564331 cd
60%	677197 cd
70%	790064 cd
80%	902930 cd

Conditions:

Number of c-planes: 2

Candela at center: 1128662 cd

ISO LUX DIAGRAM

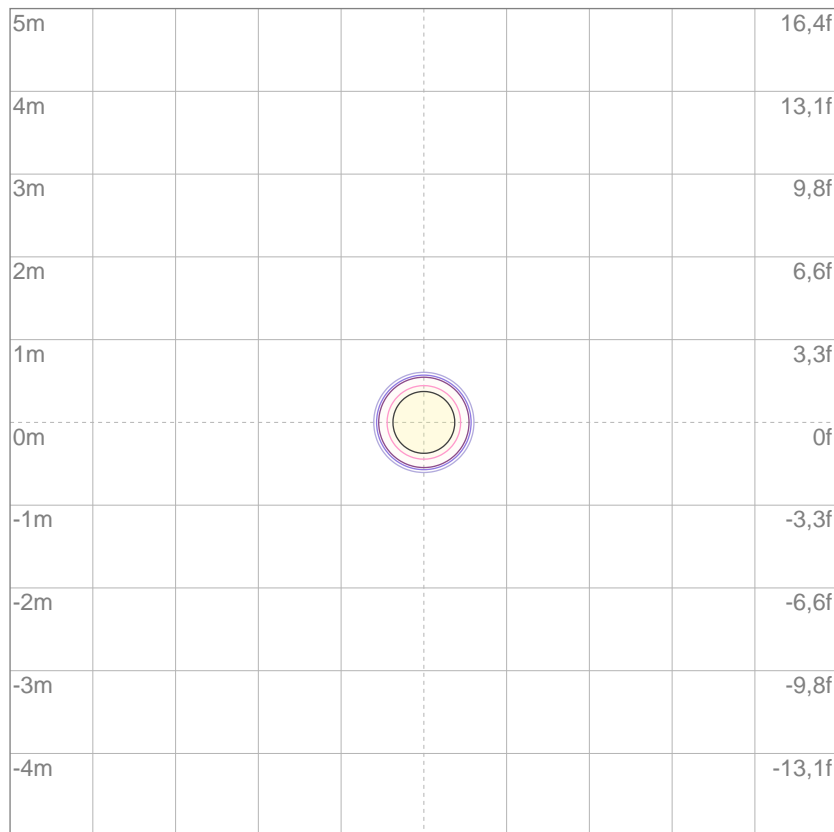

3%	339 lx
5%	564 lx
10%	1129 lx
30%	3386 lx
50%	5643 lx

Conditions:

Number of c-planes: 2

Lux at center: 11,3K lx

Lux distribution on a surface when lamp is mounted at 10 meters from the surface.

Mounting height: 10 meters (33 feet)



Total lumen output:

2033 lm

Peak candela output:

6177 cd

PRODUCT NAME:

ASTRAWASH19PIX

MEASUREMENT CONDITIONS:

Beam angle:

Max Zoom

Target:

Red

Operator:

Paolo Carvone

Date and time:

15/02/2021 12:56:18

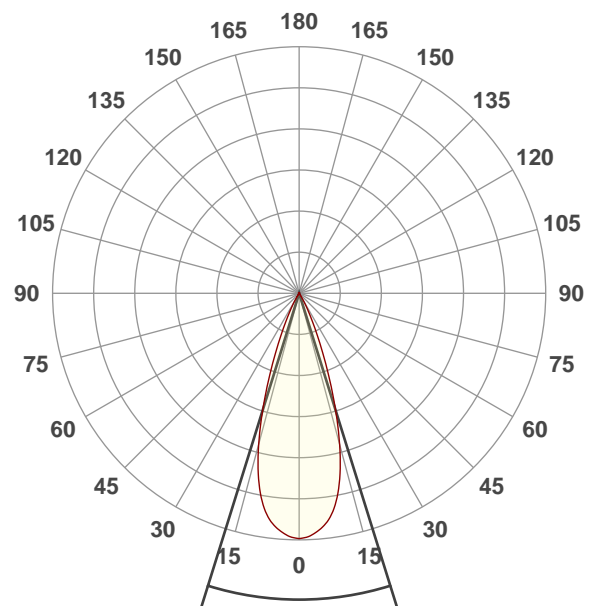

Beam angle 50%: 34,6°

Field angle 10%: 52,7°

Cut off angle 2.5%: 62,1°

Spectra

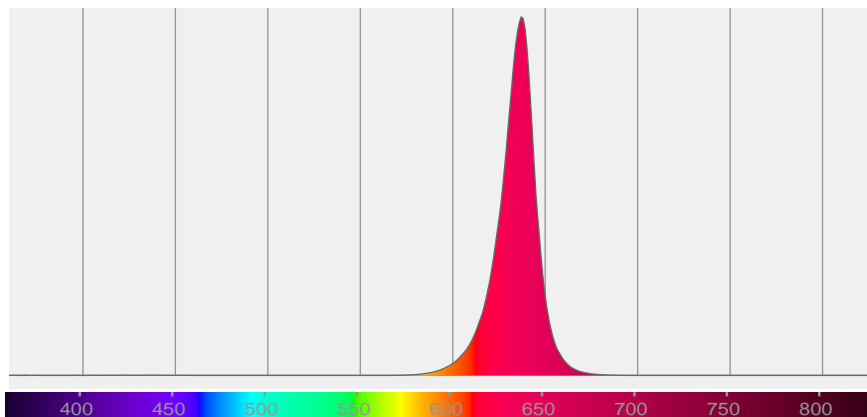

BEAM DETAILS



Beam angle 50%	Field angle 10%	Cut off angle 2,5%	Intensity ratio in 120° cone	Intensity ratio in 90° cone
34,6°	52,7°	62,1°	100,0%	99,9%

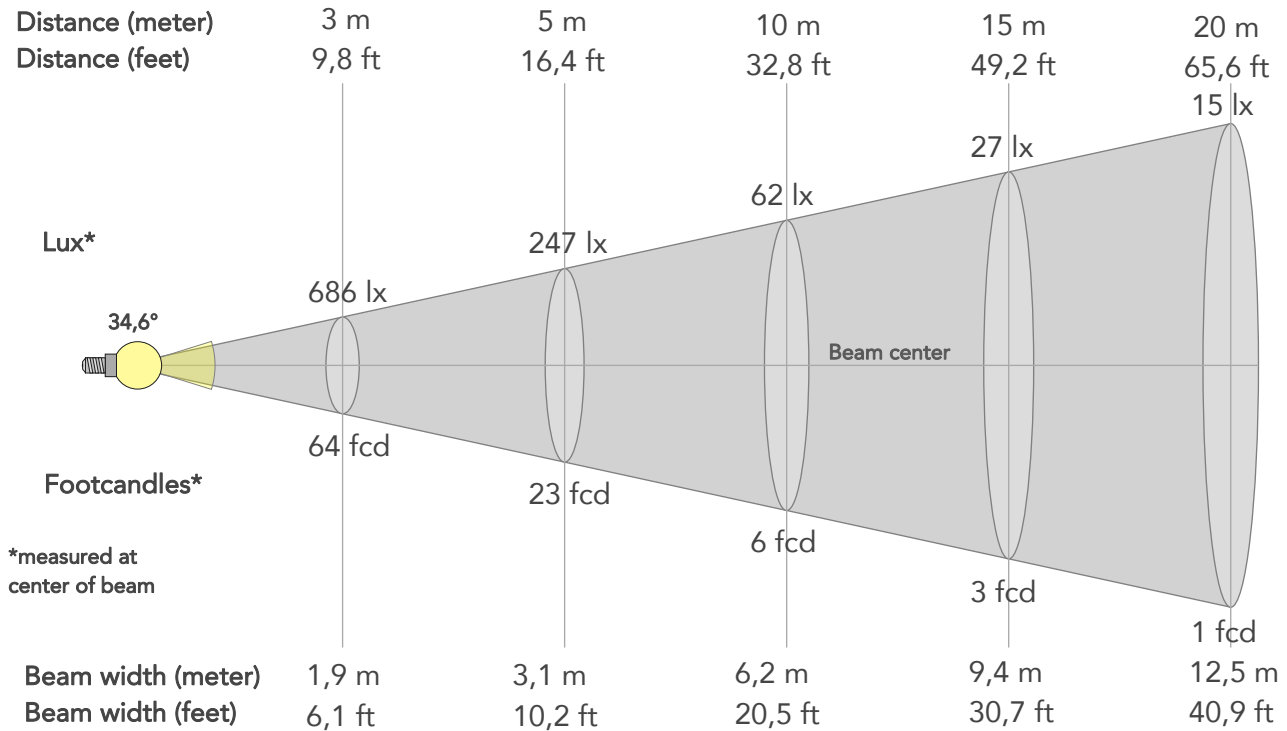

BEAM INTENSITIES AND WIDTHS

Distance	1m	2m	3m	4m	5m	7,5m	10m	15m	20m	25m	30m	40m	50m
Distance	3,3ft	6,6ft	9,8ft	13,1ft	16,4ft	24,6ft	32,8ft	49,2ft	65,6ft	82ft	98,4ft	131,2ft	164ft
Lux	6177lx	1544lx	686lx	386lx	247lx	110lx	62lx	27lx	15lx	10lx	7lx	4lx	2lx
Footcand.	574fcd	143fcd	64fcd	36fcd	23fcd	10fcd	6fcd	3fcd	1fcd	1fcd	1fcd	0fcd	0fcd
Beam wid.	0,6m	1,2m	1,9m	2,5m	3,1m	4,7m	6,2m	9,4m	12,5m	15,6m	18,7m	24,9m	31,2m
Beam wid.	2,1ft	4,1ft	6,1ft	8,2ft	10,2ft	15,3ft	20,5ft	30,7ft	40,9ft	51,1ft	61,4ft	81,8ft	102,3ft

LINEAR DISTRIBUTION DIAGRAM

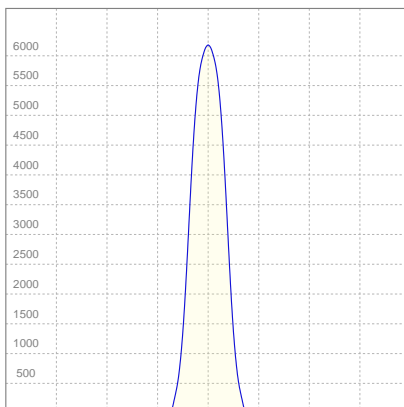

ELECTRICAL SPECIFICATIONS

Input voltage	Input current	Input power	Effeciency
226V	1,01A	196,1W	10lm/W

Power FC
0,86

ISO CANDELA DIAGRAM

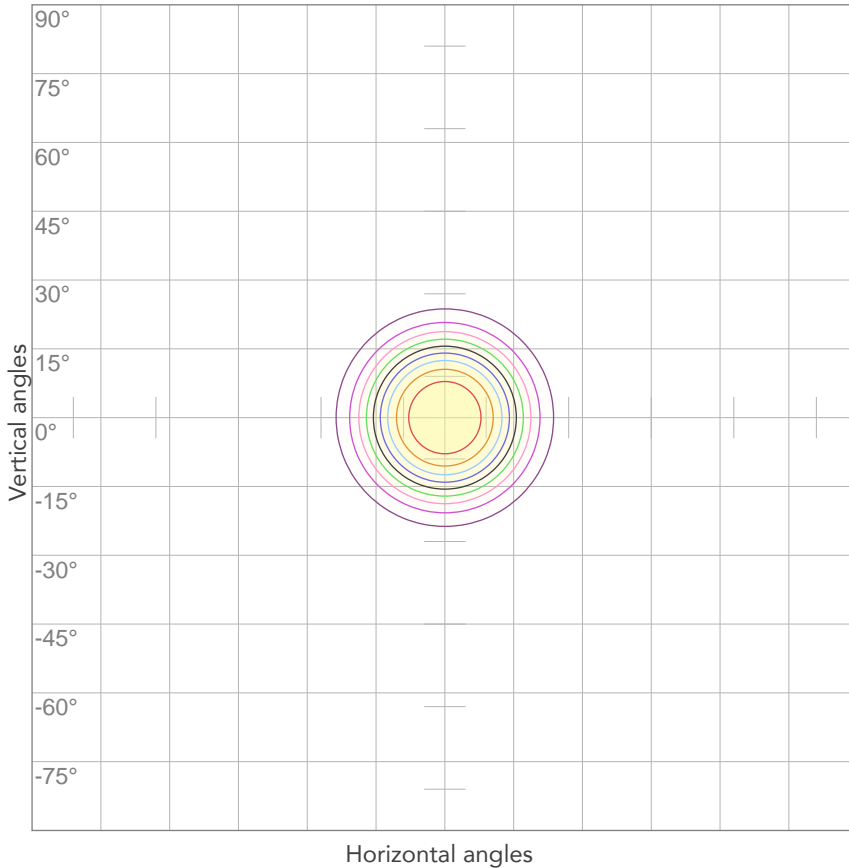

10%	618 cd
20%	1235 cd
30%	1853 cd
40%	2471 cd
50%	3088 cd
60%	3706 cd
70%	4324 cd
80%	4942 cd

Conditions:

Number of c-planes: 2

Candela at center: 6177 cd

ISO LUX DIAGRAM

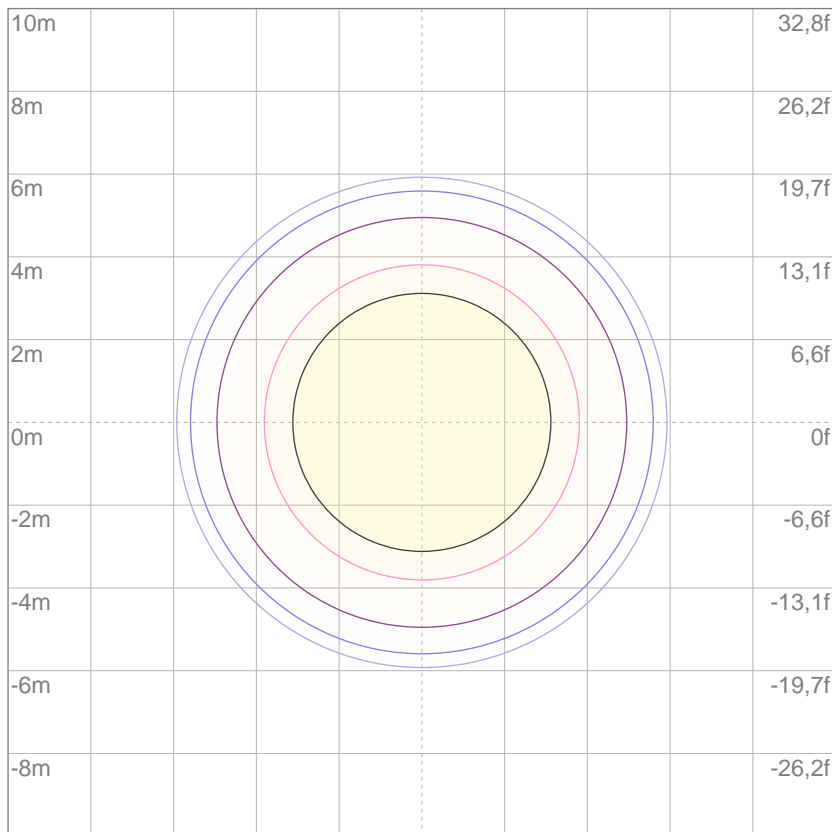

3%	1,85 lx
5%	3,09 lx
10%	6,18 lx
30%	18,5 lx
50%	30,9 lx

Conditions:

Number of c-planes: 2

Lux at center: 61,8 lx

Lux distribution on a surface when lamp is mounted at 10 meters from the surface.

Mounting height: 10 meters (33 feet)



Total lumen output:

1729 lm

Peak candela output:

21656 cd

PRODUCT NAME:

ASTRAWASH19PIX

MEASUREMENT CONDITIONS:

Beam angle:

Med Zoom

Target:

Red

Operator:

Paolo Carvone

Date and time:

15/02/2021 12:54:52

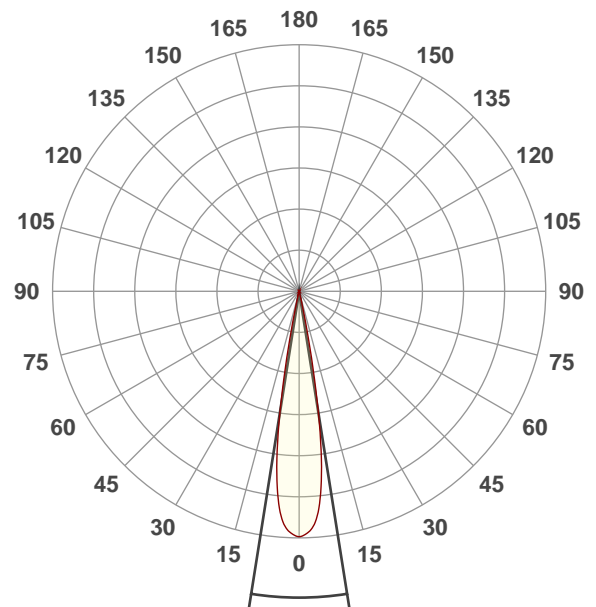

Beam angle 50%: 18°

Field angle 10%: 24,1°

Cut off angle 2.5%: 26,6°

Spectra

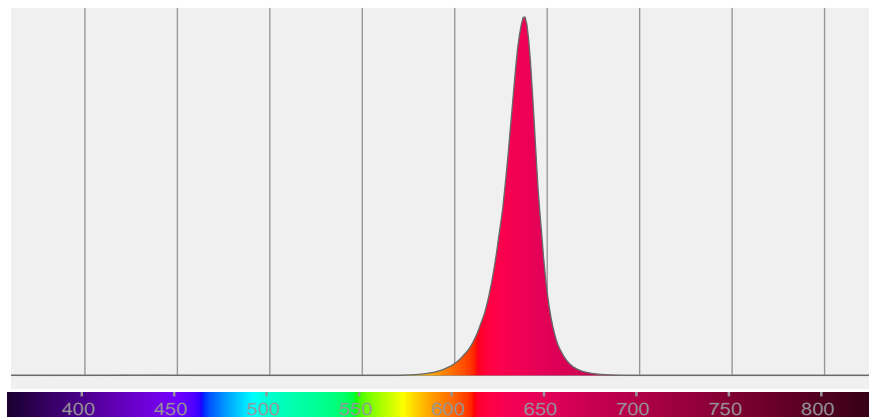

Beam angle 50%	Field angle 10%	Cut off angle 2,5%	Intensity ratio in 120° cone	Intensity ratio in 90° cone
18°	24,1°	26,6°	100,0%	99,9%

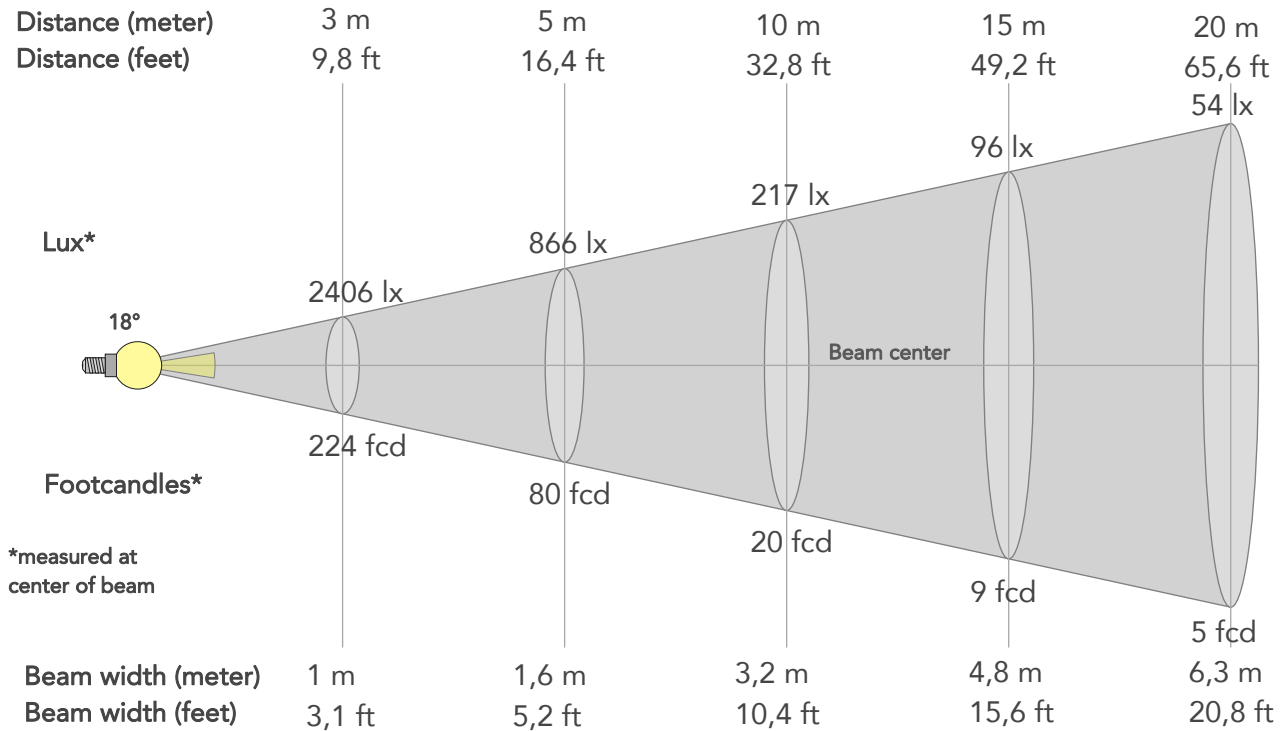

BEAM INTENSITIES AND WIDTHS

Distance	1m	2m	3m	4m	5m	7,5m	10m	15m	20m	25m	30m	40m	50m
Distance	3,3ft	6,6ft	9,8ft	13,1ft	16,4ft	24,6ft	32,8ft	49,2ft	65,6ft	82ft	98,4ft	131,2ft	164ft
Lux	21656lx	5414lx	2406lx	1353lx	866lx	385lx	217lx	96lx	54lx	35lx	24lx	14lx	9lx
Footcand.	2012fcd	503fcd	224fcd	126fcd	80fcd	36fcd	20fcd	9fcd	5fcd	3fcd	2fcd	1fcd	1fcd
Beam wid.	0,3m	0,6m	1m	1,3m	1,6m	2,4m	3,2m	4,8m	6,3m	7,9m	9,5m	12,7m	15,9m
Beam wid.	1ft	2,1ft	3,1ft	4,2ft	5,2ft	7,8ft	10,4ft	15,6ft	20,8ft	26ft	31,2ft	41,6ft	52ft

LINEAR DISTRIBUTION DIAGRAM

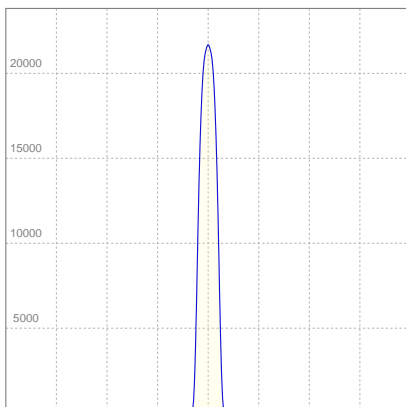

ELECTRICAL SPECIFICATIONS

Input voltage	Input current	Input power	Effeciency
227V	1,01A	195,5W	9lm/W

Power FC
0,86

ISO CANDELA DIAGRAM

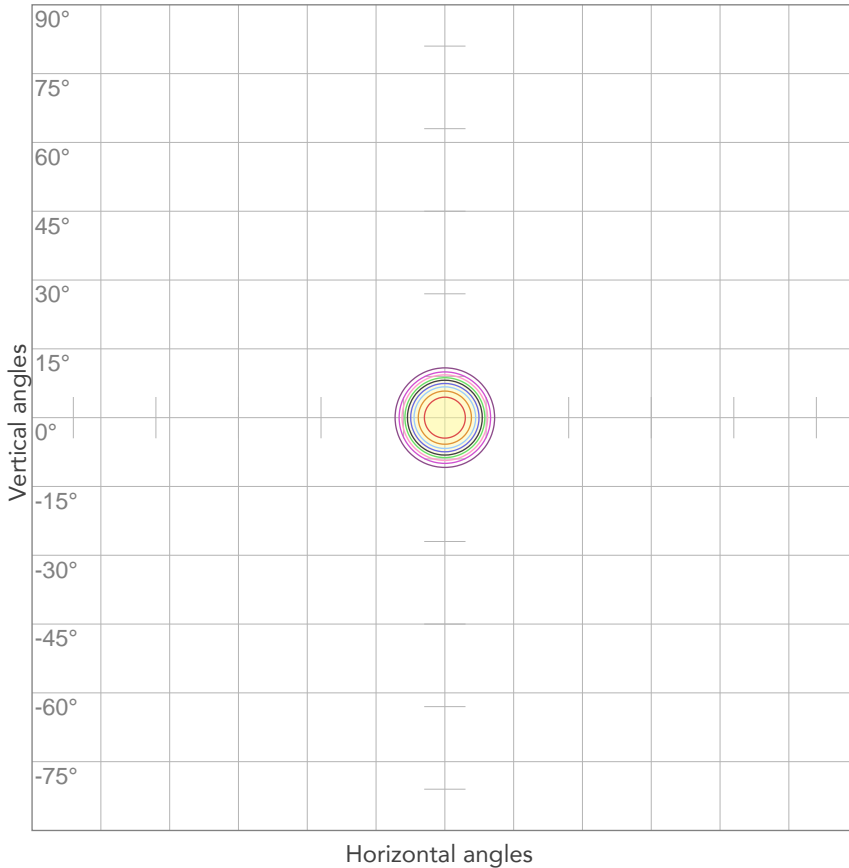

10%	2166 cd
20%	4331 cd
30%	6497 cd
40%	8662 cd
50%	10828 cd
60%	12993 cd
70%	15159 cd
80%	17325 cd

Conditions:

Number of c-planes: 2

Candela at center: 21656 cd

ISO LUX DIAGRAM

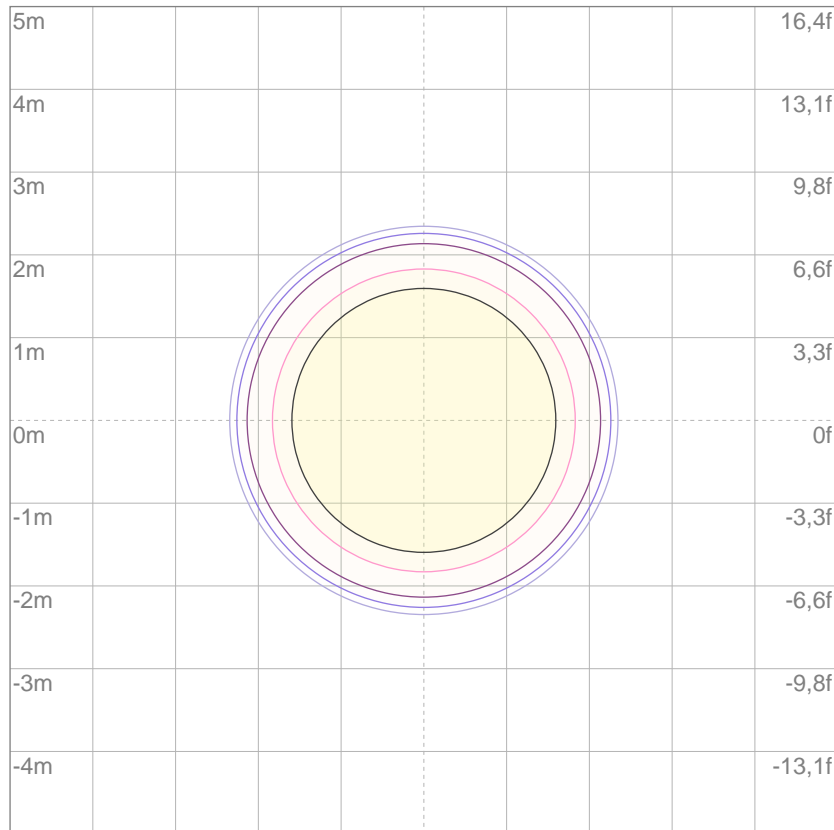

3%	6,50 lx
5%	10,8 lx
10%	21,7 lx
30%	65,0 lx
50%	108 lx

Conditions:

Number of c-planes: 2

Lux at center: 217 lx

Lux distribution on a surface when lamp is mounted at 10 meters from the surface.

Mounting height: 10 meters (33 feet)



Total lumen output:

1129 lm

Peak candela output:

226611 cd

PRODUCT NAME:

ASTRAWASH19PIX

MEASUREMENT CONDITIONS:

Beam angle:

Min Zoom

Target:

Red

Operator:

Paolo Carvone

Date and time:

15/02/2021 11:10:54

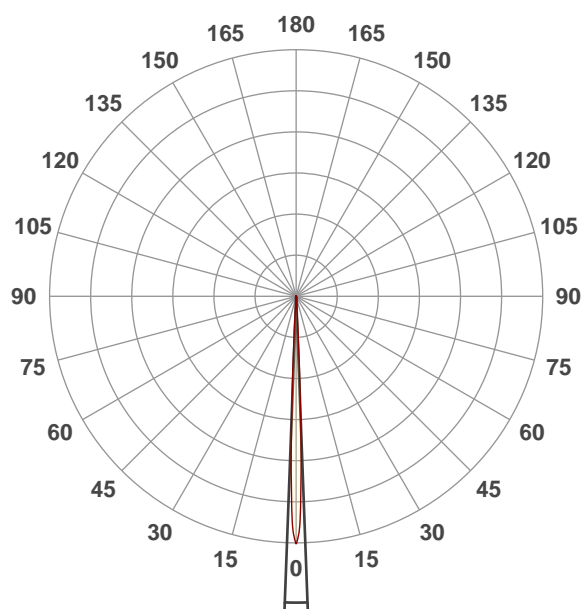

Beam angle 50%: 4,3°

Field angle 10%: 6,5°

Cut off angle 2.5%: 7,7°

Spectra

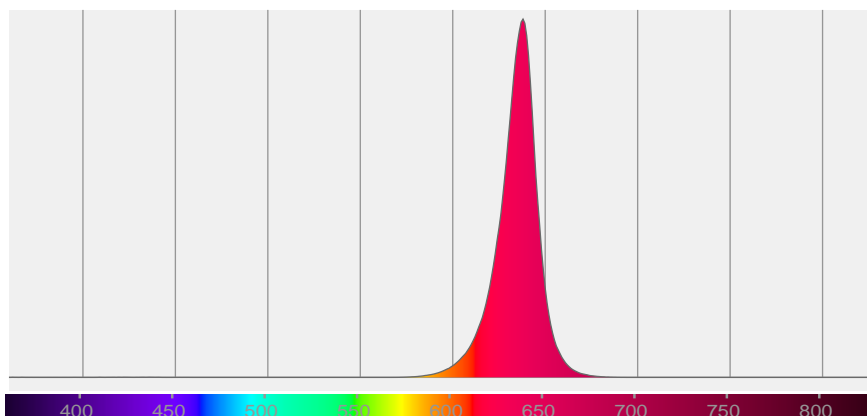

BEAM DETAILS



Beam angle 50%	Field angle 10%	Cut off angle 2,5%	Intensity ratio in 120° cone	Intensity ratio in 90° cone
4,3°	6,5°	7,7°	100,0%	100,0%

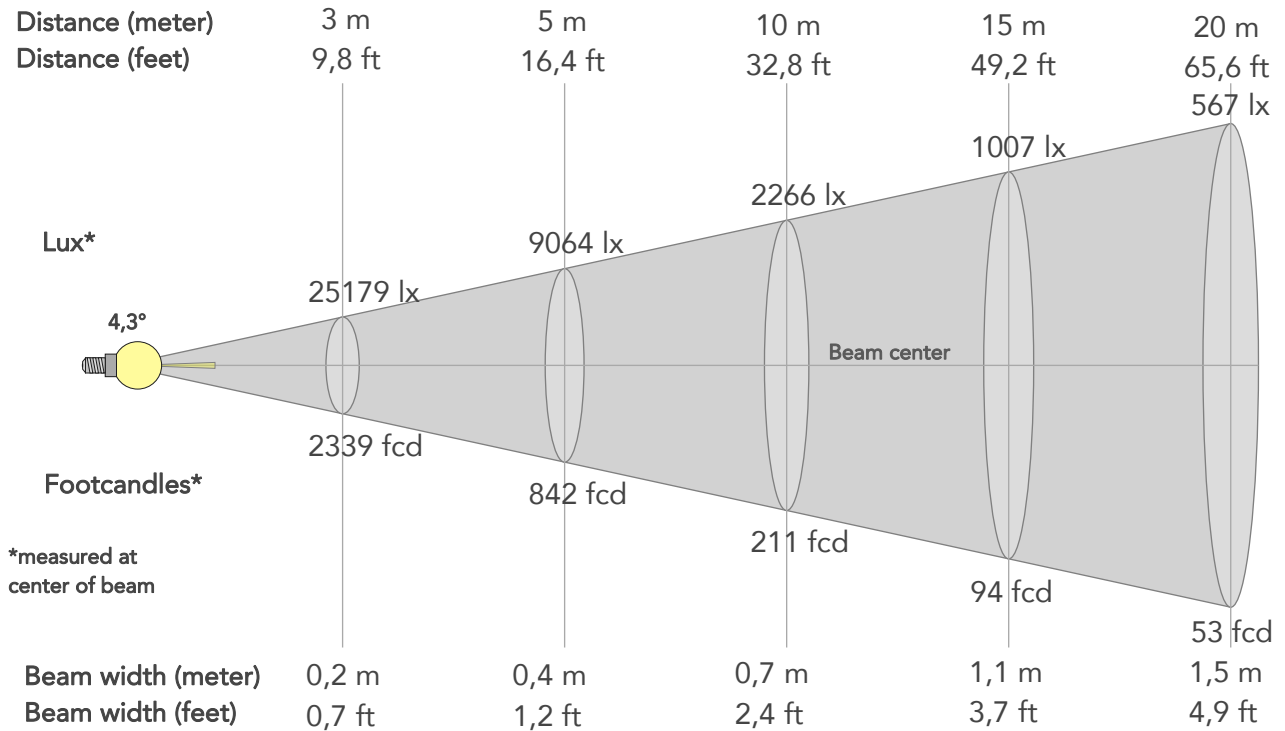

BEAM INTENSITIES AND WIDTHS

Distance	1m	2m	3m	4m	5m	7,5m	10m	15m	20m	25m	30m	40m	50m
Distance	3,3ft	6,6ft	9,8ft	13,1ft	16,4ft	24,6ft	32,8ft	49,2ft	65,6ft	82ft	98,4ft	131,2ft	164ft
Lux	226611lx	56653lx	25179lx	14163lx	9064lx	4029lx	2266lx	1007lx	567lx	363lx	252lx	142lx	91lx
Footcand.	21053fcd	5263fcd	2339fcd	1316fcd	842fcd	374fcd	211fcd	94fcd	53fcd	34fcd	23fcd	13fcd	8fcd
Beam wid.	0,1m	0,1m	0,2m	0,3m	0,4m	0,6m	0,7m	1,1m	1,5m	1,9m	2,2m	3m	3,7m
Beam wid.	0,2ft	0,5ft	0,7ft	1ft	1,2ft	1,8ft	2,4ft	3,7ft	4,9ft	6,1ft	7,3ft	9,7ft	12,2ft

LINEAR DISTRIBUTION DIAGRAM

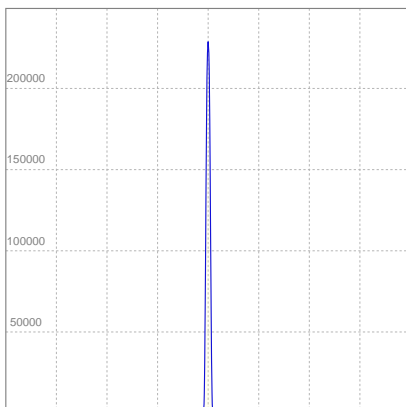

ELECTRICAL SPECIFICATIONS

Input voltage	Input current	Input power	Effeciency
224V	1,03A	196,3W	6lm/W

Power FC
0,85

ISO CANDELA DIAGRAM

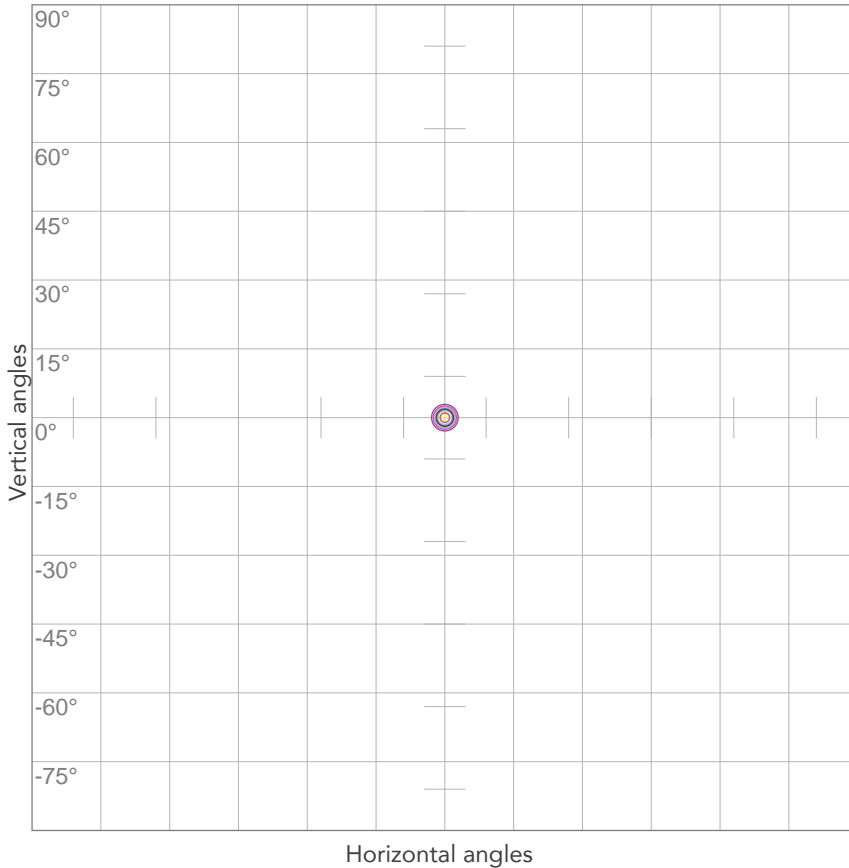

10%	22661 cd
20%	45322 cd
30%	67983 cd
40%	90645 cd
50%	113306 cd
60%	135967 cd
70%	158628 cd
80%	181289 cd

Conditions:
 Number of c-planes: 2
 Candela at center: 226611 cd

ISO LUX DIAGRAM

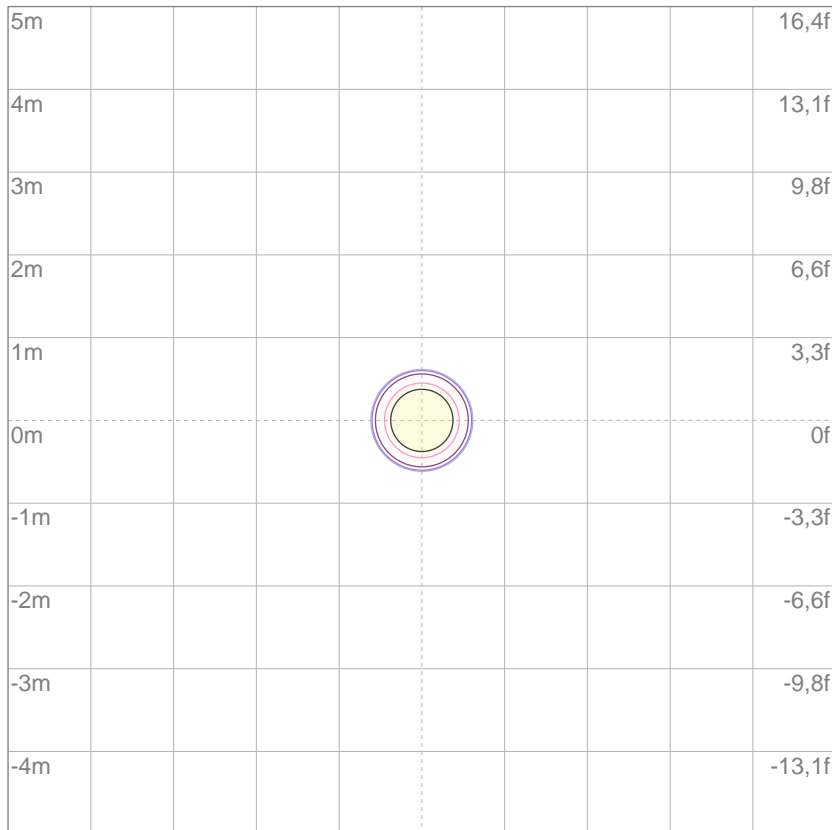

3%	68,0 lx
5%	113 lx
10%	227 lx
30%	680 lx
50%	1133 lx

Conditions:
 Number of c-planes: 2
 Lux at center: 2266 lx

Lux distribution on a surface when lamp is mounted at 10 meters from the surface.

Mounting height: 10 meters (33 feet)



Total lumen output:

3277 lm

Peak candela output:

9884 cd

PRODUCT NAME:

ASTRAWASH19PIX

MEASUREMENT CONDITIONS:

Beam angle:

Max Zoom

Target:

Green

Operator:

Paolo Carvone

Date and time:

15/02/2021 12:53:20

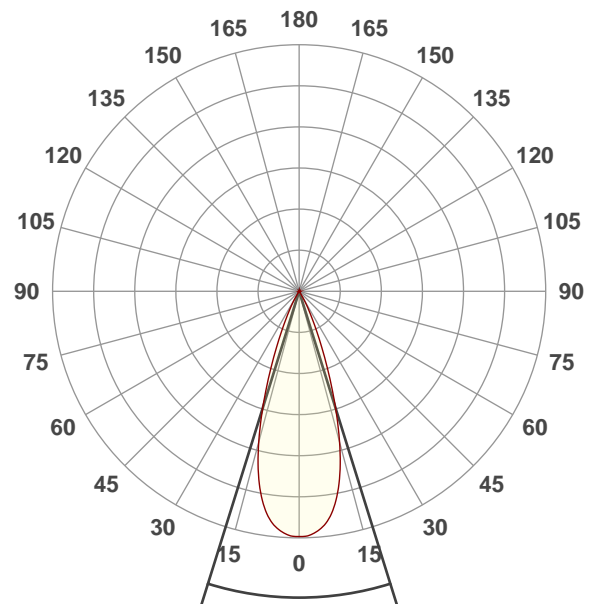

Beam angle 50%: 34,6°

Field angle 10%: 53°

Cut off angle 2.5%: 62°

Spectra

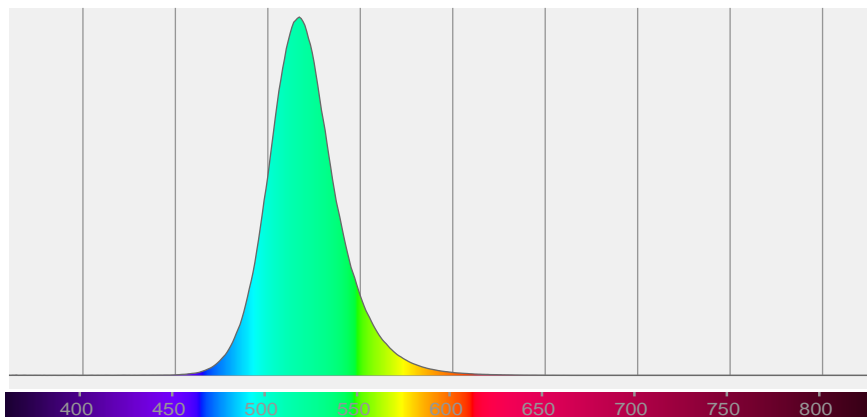

BEAM DETAILS



Beam angle 50%	Field angle 10%	Cut off angle 2,5%	Intensity ratio in 120° cone	Intensity ratio in 90° cone
34,6°	53°	62°	99,9%	99,8%

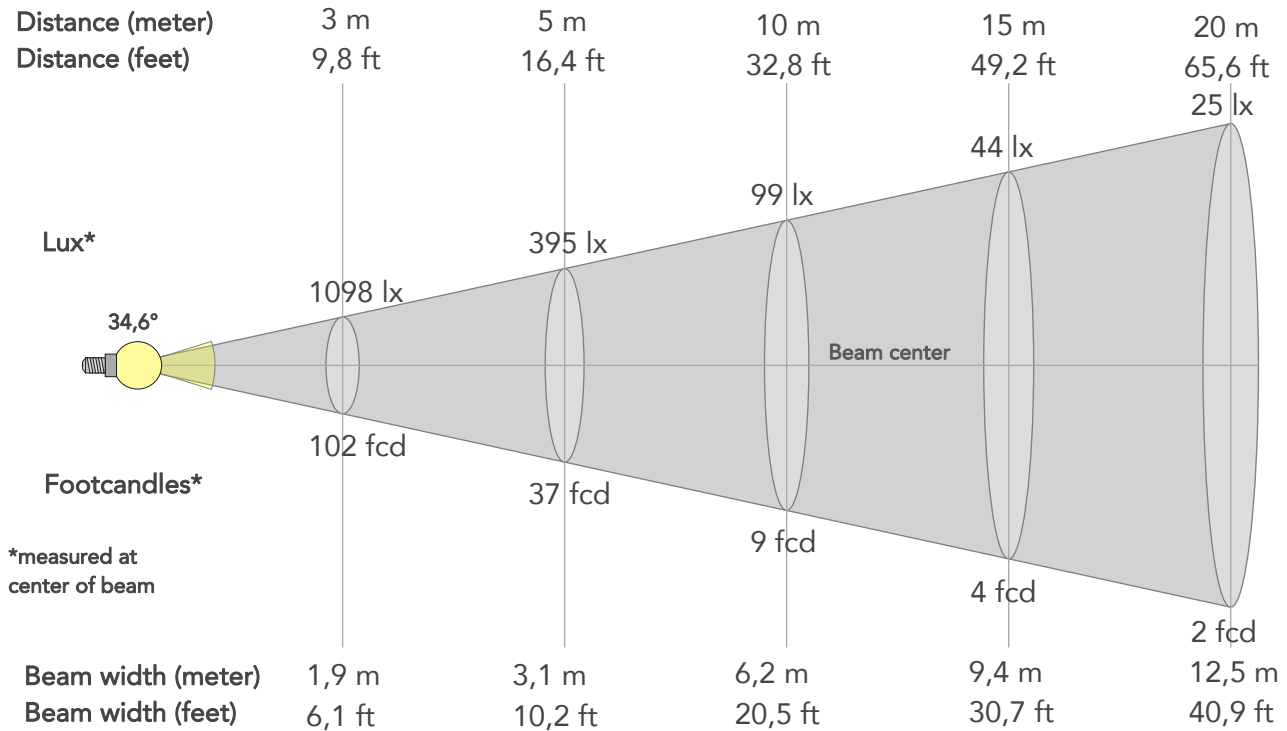

BEAM INTENSITIES AND WIDTHS

Distance	1m	2m	3m	4m	5m	7,5m	10m	15m	20m	25m	30m	40m	50m
Distance	3,3ft	6,6ft	9,8ft	13,1ft	16,4ft	24,6ft	32,8ft	49,2ft	65,6ft	82ft	98,4ft	131,2ft	164ft
Lux	9884lx	2471lx	1098lx	618lx	395lx	176lx	99lx	44lx	25lx	16lx	11lx	6lx	4lx
Footcand.	918fcd	230fcd	102fcd	57fcd	37fcd	16fcd	9fcd	4fcd	2fcd	1fcd	1fcd	1fcd	0fcd
Beam wid.	0,6m	1,2m	1,9m	2,5m	3,1m	4,7m	6,2m	9,4m	12,5m	15,6m	18,7m	24,9m	31,2m
Beam wid.	2,1ft	4,1ft	6,1ft	8,2ft	10,2ft	15,3ft	20,5ft	30,7ft	40,9ft	51,1ft	61,4ft	81,8ft	102,3ft

LINEAR DISTRIBUTION DIAGRAM

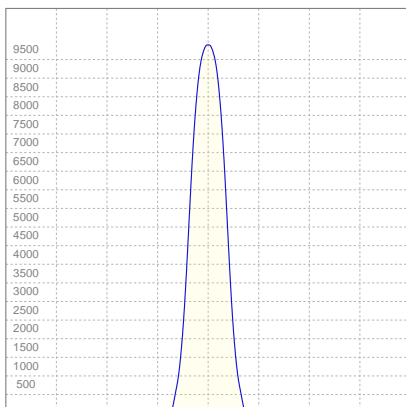

ELECTRICAL SPECIFICATIONS

Input voltage	Input current	Input power	Effeciency
226V	1,26A	255,2W	13lm/W

Power FC
0,9

ISO CANDELA DIAGRAM

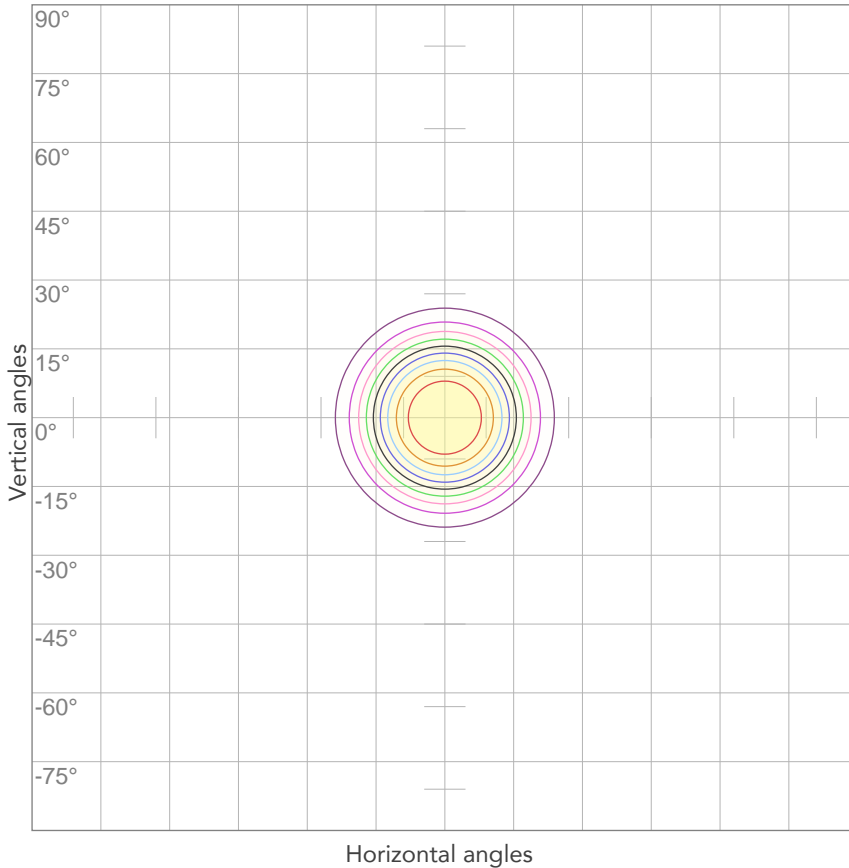

10%	988 cd
20%	1977 cd
30%	2965 cd
40%	3954 cd
50%	4942 cd
60%	5930 cd
70%	6919 cd
80%	7907 cd

Conditions:

Number of c-planes: 2

Candela at center: 9884 cd

ISO LUX DIAGRAM

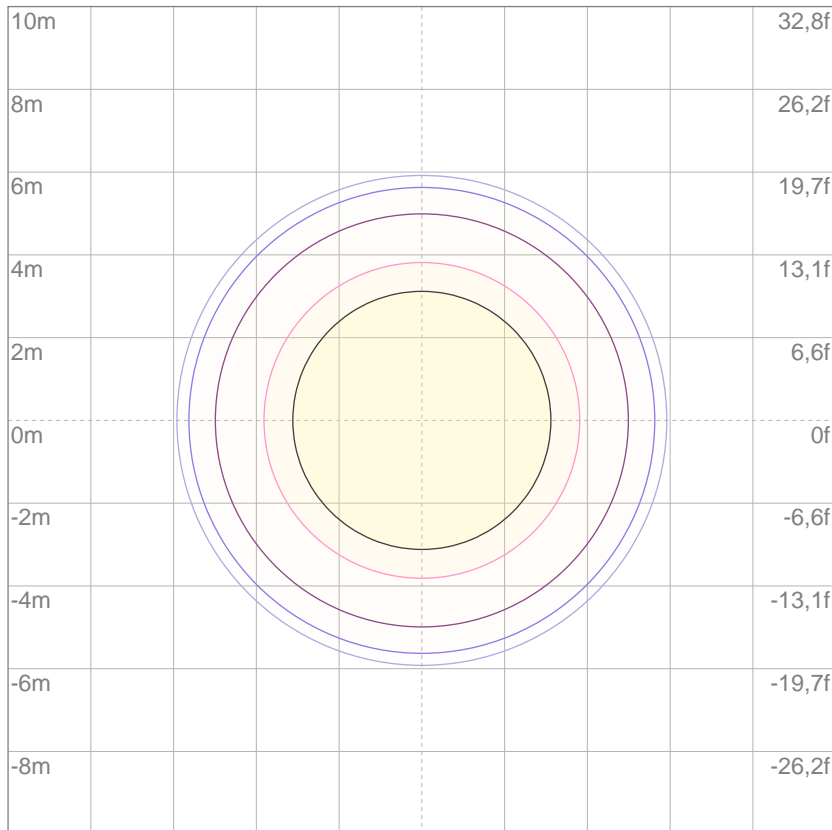

Mounting height: 10 meters (33 feet)

3%	2,97 lx
5%	4,94 lx
10%	9,88 lx
30%	29,7 lx
50%	49,4 lx

Conditions:

Number of c-planes: 2

Lux at center: 98,8 lx

Lux distribution on a surface when lamp is mounted at 10 meters from the surface.



Total lumen output:

2795 lm

Peak candela output:

35825 cd

PRODUCT NAME:

ASTRAWASH19PIX

MEASUREMENT CONDITIONS:

Beam angle:

Med Zoom

Target:

Green

Operator:

Paolo Carvone

Date and time:

15/02/2021 12:51:55

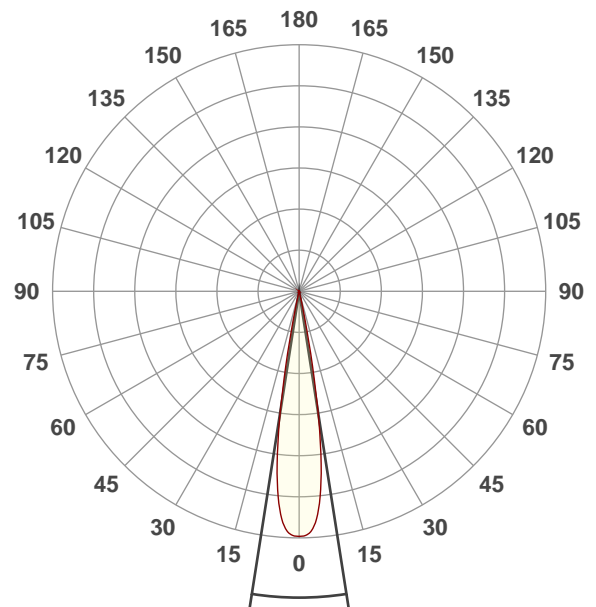

Beam angle 50%: 17,8°

Field angle 10%: 23,9°

Cut off angle 2.5%: 26,1°

Spectra

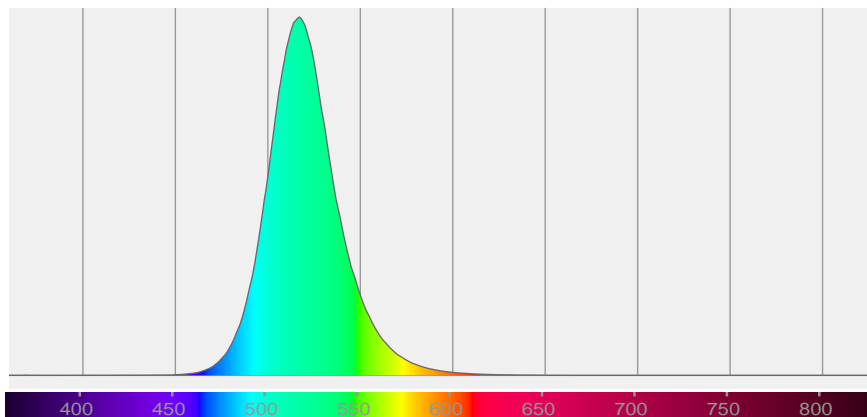

BEAM DETAILS



Beam angle 50%	Field angle 10%	Cut off angle 2,5%	Intensity ratio in 120° cone	Intensity ratio in 90° cone
17,8°	23,9°	26,1°	99,9%	99,8%

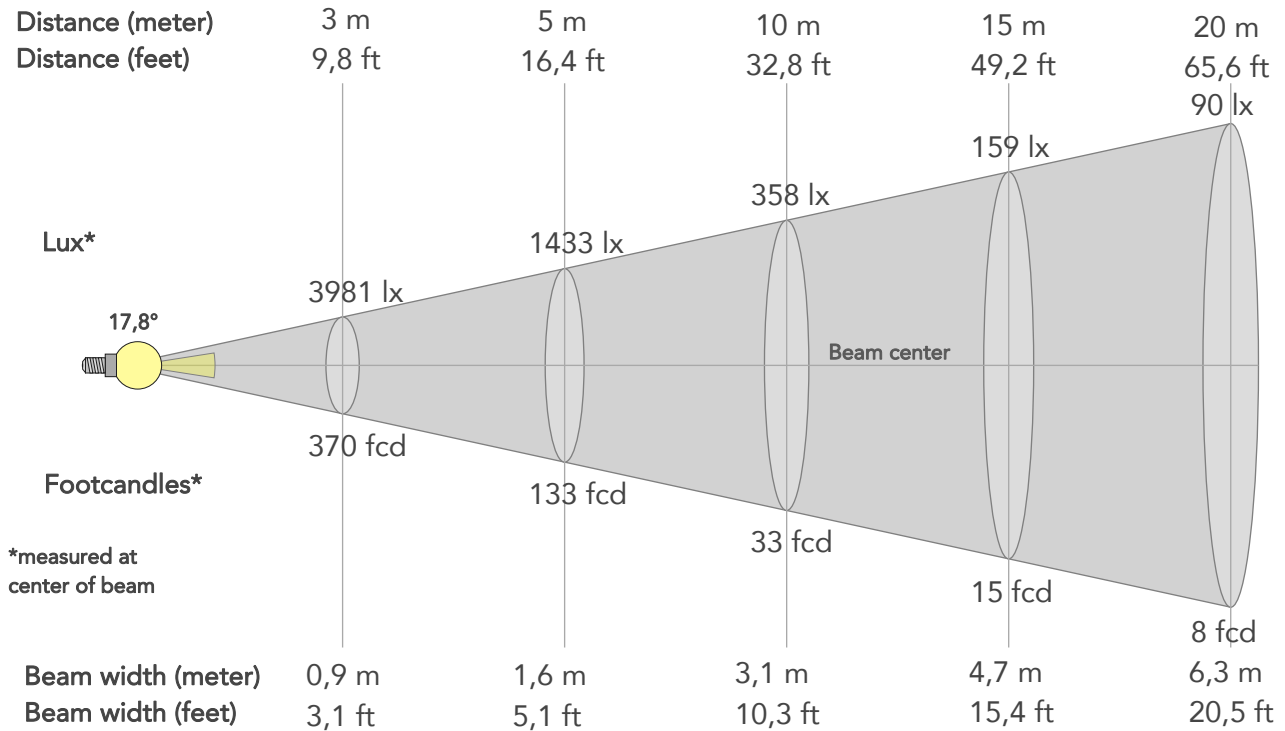

BEAM INTENSITIES AND WIDTHS

Distance	1m	2m	3m	4m	5m	7,5m	10m	15m	20m	25m	30m	40m	50m
Distance	3,3ft	6,6ft	9,8ft	13,1ft	16,4ft	24,6ft	32,8ft	49,2ft	65,6ft	82ft	98,4ft	131,2ft	164ft
Lux	35825lx	8956lx	3981lx	2239lx	1433lx	637lx	358lx	159lx	90lx	57lx	40lx	22lx	14lx
Footcand.	3328fcd	832fcd	370fcd	208fcd	133fcd	59fcd	33fcd	15fcd	8fcd	5fcd	4fcd	2fcd	1fcd
Beam wid.	0,3m	0,6m	0,9m	1,3m	1,6m	2,3m	3,1m	4,7m	6,3m	7,8m	9,4m	12,5m	15,6m
Beam wid.	1ft	2,1ft	3,1ft	4,1ft	5,1ft	7,7ft	10,3ft	15,4ft	20,5ft	25,6ft	30,8ft	41ft	51,3ft

LINEAR DISTRIBUTION DIAGRAM

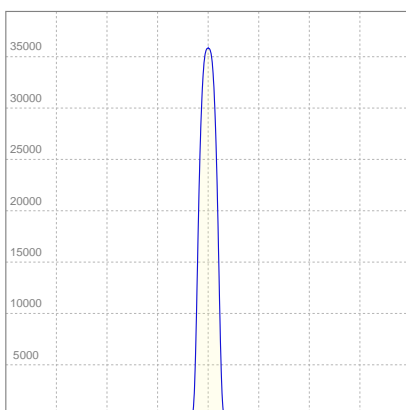

ELECTRICAL SPECIFICATIONS

Input voltage	Input current	Input power	Effeciency
226V	1,26A	254,3W	11lm/W

Power FC
0,9

ISO CANDELA DIAGRAM

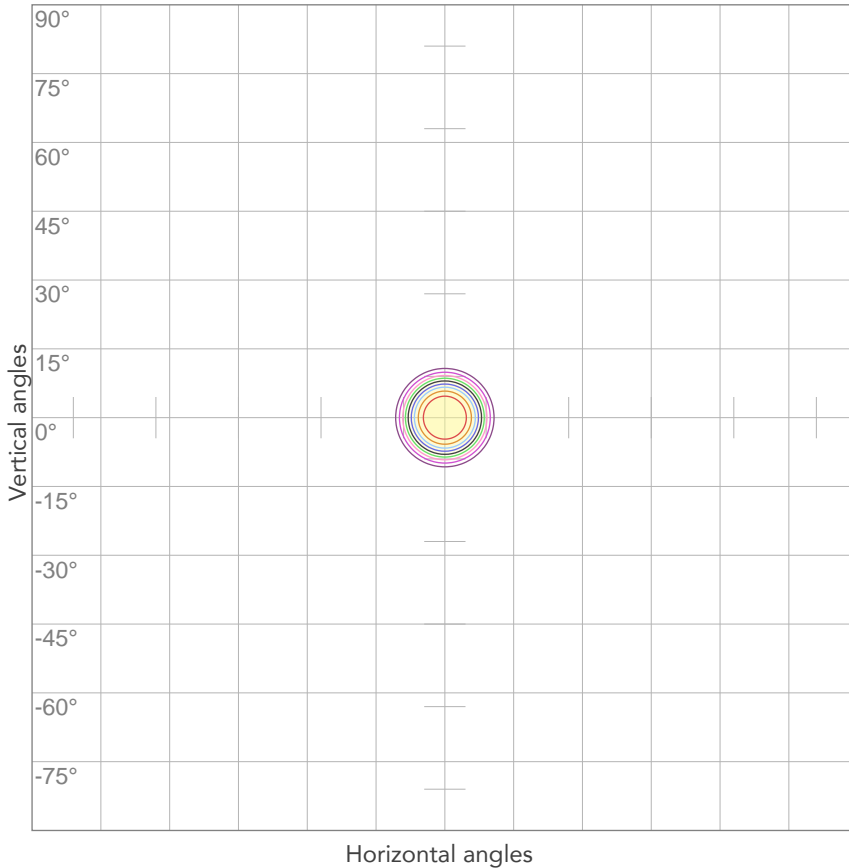

10%	3582 cd
20%	7165 cd
30%	10747 cd
40%	14330 cd
50%	17912 cd
60%	21495 cd
70%	25077 cd
80%	28660 cd

Conditions:

Number of c-planes: 2

Candela at center: 35825 cd

ISO LUX DIAGRAM

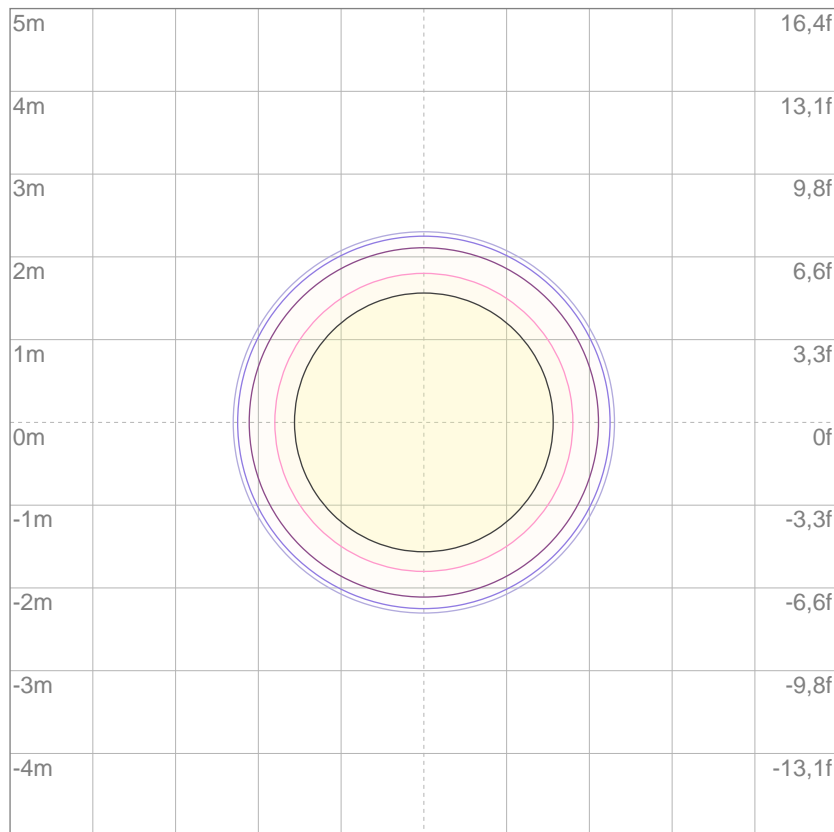

3%	10,7 lx
5%	17,9 lx
10%	35,8 lx
30%	107 lx
50%	179 lx

Conditions:

Number of c-planes: 2

Lux at center: 358 lx

Lux distribution on a surface when lamp is mounted at 10 meters from the surface.

Mounting height: 10 meters (33 feet)



Total lumen output:

1858 lm

Peak candela output:

374281 cd

PRODUCT NAME:

ASTRAWASH19PIX

MEASUREMENT CONDITIONS:

Beam angle:

Min Zoom

Target:

Green

Operator:

Paolo Carvone

Date and time:

15/02/2021 11:12:56

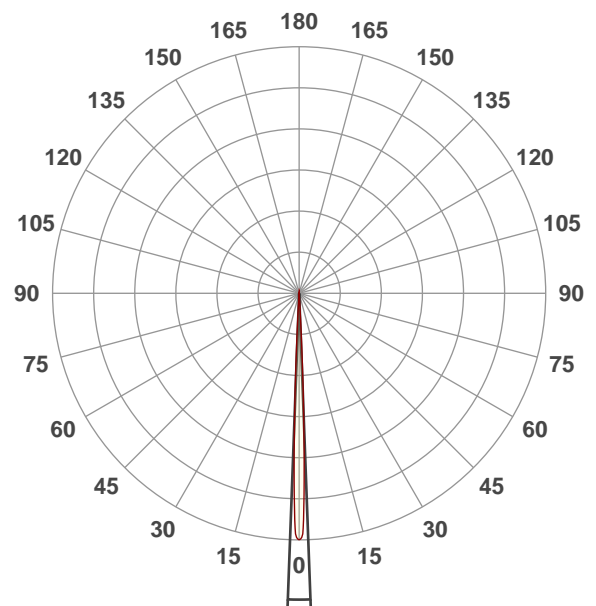

Beam angle 50%: 4,2°

Field angle 10%: 6,3°

Cut off angle 2.5%: 7,2°

Spectra

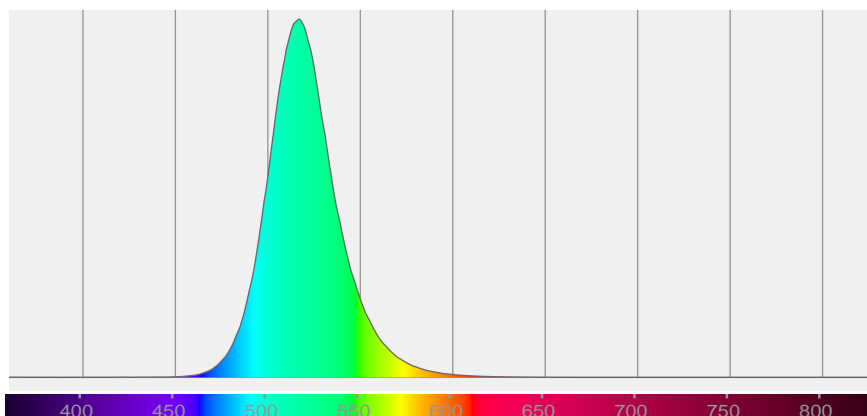

BEAM DETAILS



Beam angle 50%	Field angle 10%	Cut off angle 2,5%	Intensity ratio in 120° cone	Intensity ratio in 90° cone
4,2°	6,3°	7,2°	100,0%	100,0%

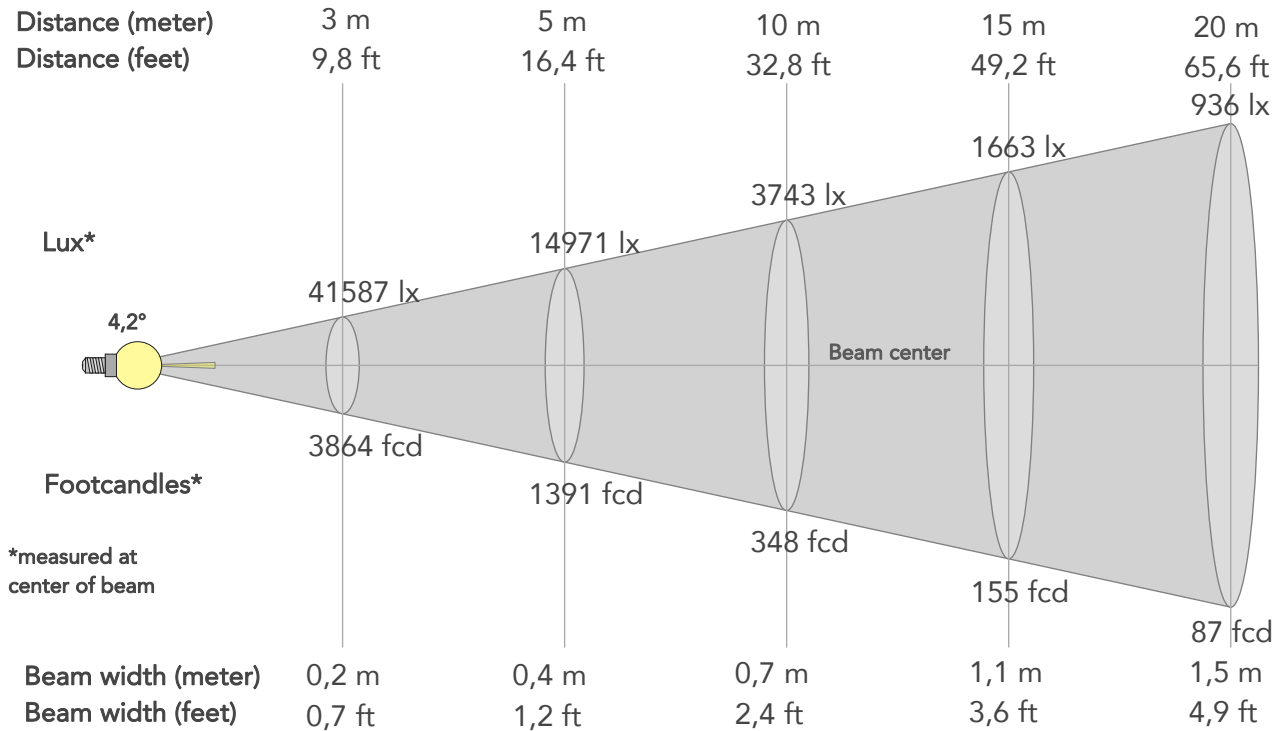

BEAM INTENSITIES AND WIDTHS

Distance	1m	2m	3m	4m	5m	7,5m	10m	15m	20m	25m	30m	40m	50m
Distance	3,3ft	6,6ft	9,8ft	13,1ft	16,4ft	24,6ft	32,8ft	49,2ft	65,6ft	82ft	98,4ft	131,2ft	164ft
Lux	374281lx	93570lx	41587lx	23393lx	14971lx	6654lx	3743lx	1663lx	936lx	599lx	416lx	234lx	150lx
Footcand.	34772fcd	8693fcd	3864fcd	2173fcd	1391fcd	618fcd	348fcd	155fcd	87fcd	56fcd	39fcd	22fcd	14fcd
Beam wid.	0,1m	0,1m	0,2m	0,3m	0,4m	0,6m	0,7m	1,1m	1,5m	1,8m	2,2m	3m	3,7m
Beam wid.	0,2ft	0,5ft	0,7ft	1ft	1,2ft	1,8ft	2,4ft	3,6ft	4,9ft	6,1ft	7,3ft	9,7ft	12,1ft

LINEAR DISTRIBUTION DIAGRAM

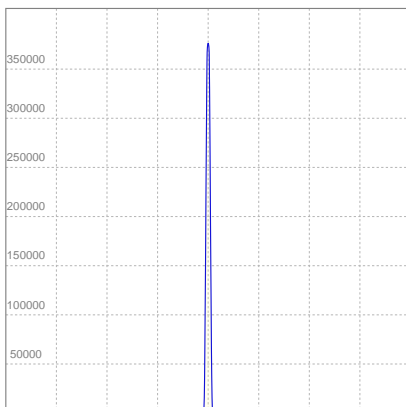

ELECTRICAL SPECIFICATIONS

Input voltage	Input current	Input power	Effeciency
223V	1,28A	256,5W	7lm/W

Power FC
0,9

ISO CANDELA DIAGRAM

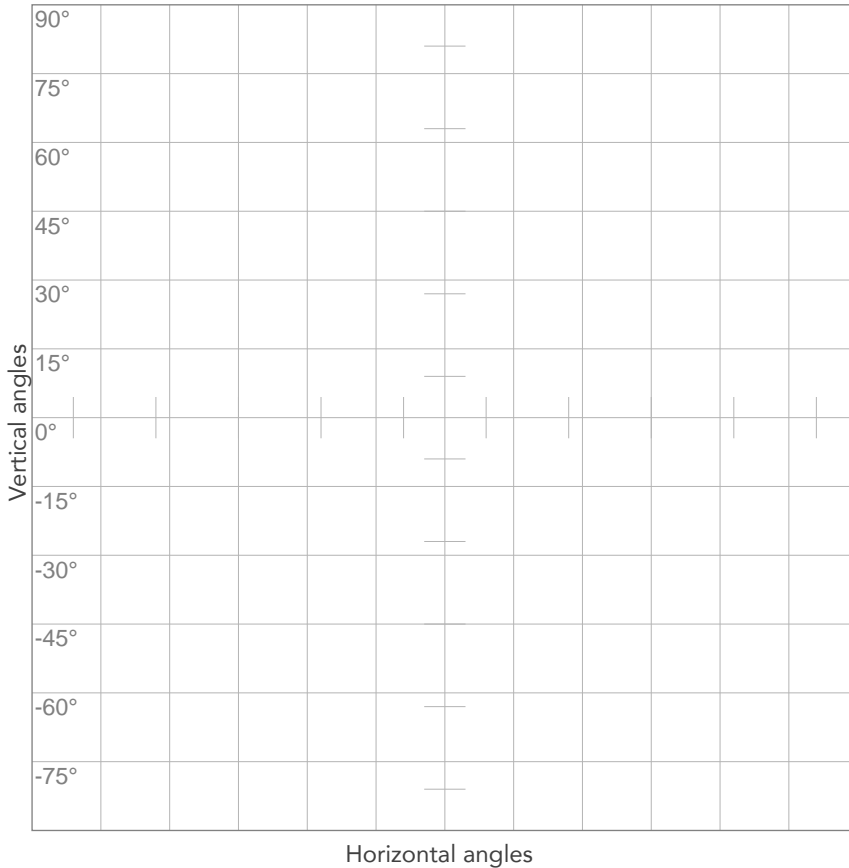

10%	37428 cd
20%	74856 cd
30%	112284 cd
40%	149712 cd
50%	187140 cd
60%	224568 cd
70%	261996 cd
80%	299424 cd

Conditions:
 Number of c-planes: 2
 Candela at center: 374281 cd

ISO LUX DIAGRAM

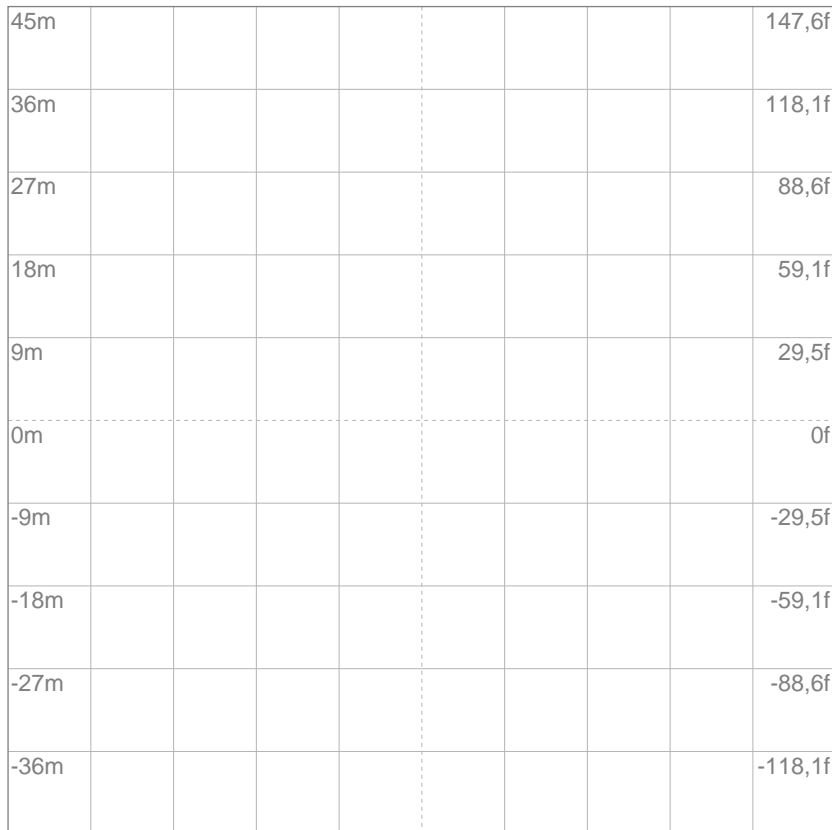

3%	112 lx
5%	187 lx
10%	374 lx
30%	1123 lx
50%	1871 lx

Conditions:
 Number of c-planes: 2
 Lux at center: 3743 lx

Lux distribution on a surface when lamp is mounted at 10 meters from the surface.

Mounting height: 10 meters (33 feet)



Total lumen output:

875 lm

Peak candela output:

2702 cd

PRODUCT NAME:

ASTRAWASH19PIX

MEASUREMENT CONDITIONS:

Beam angle:

Max Zoom

Target:

Blue

Operator:

Paolo Carvone

Date and time:

15/02/2021 12:37:46

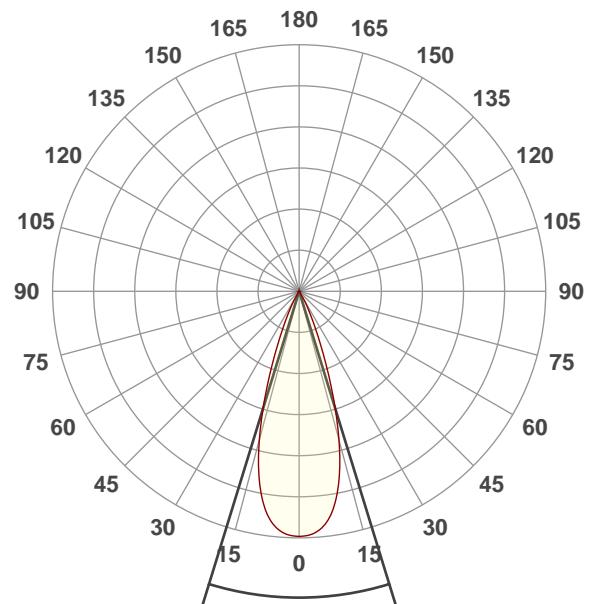

Beam angle 50%: 34,2°

Field angle 10%: 52,3°

Cut off angle 2.5%: 61,4°

Spectra

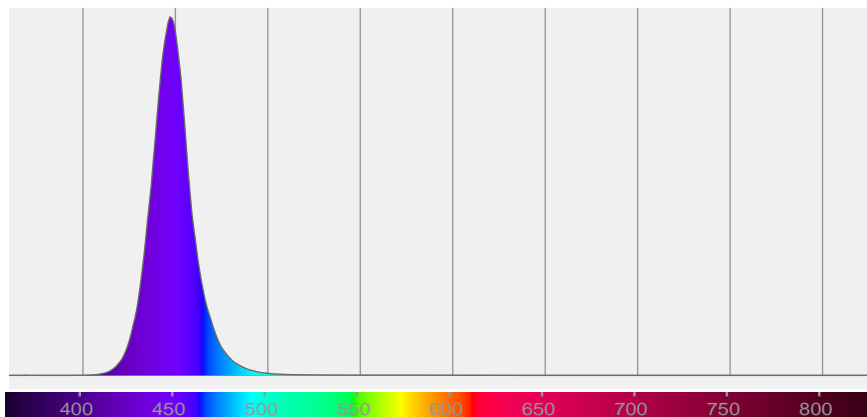

BEAM DETAILS



Beam angle 50%	Field angle 10%	Cut off angle 2,5%	Intensity ratio in 120° cone	Intensity ratio in 90° cone
34,2°	52,3°	61,4°	99,8%	99,6%

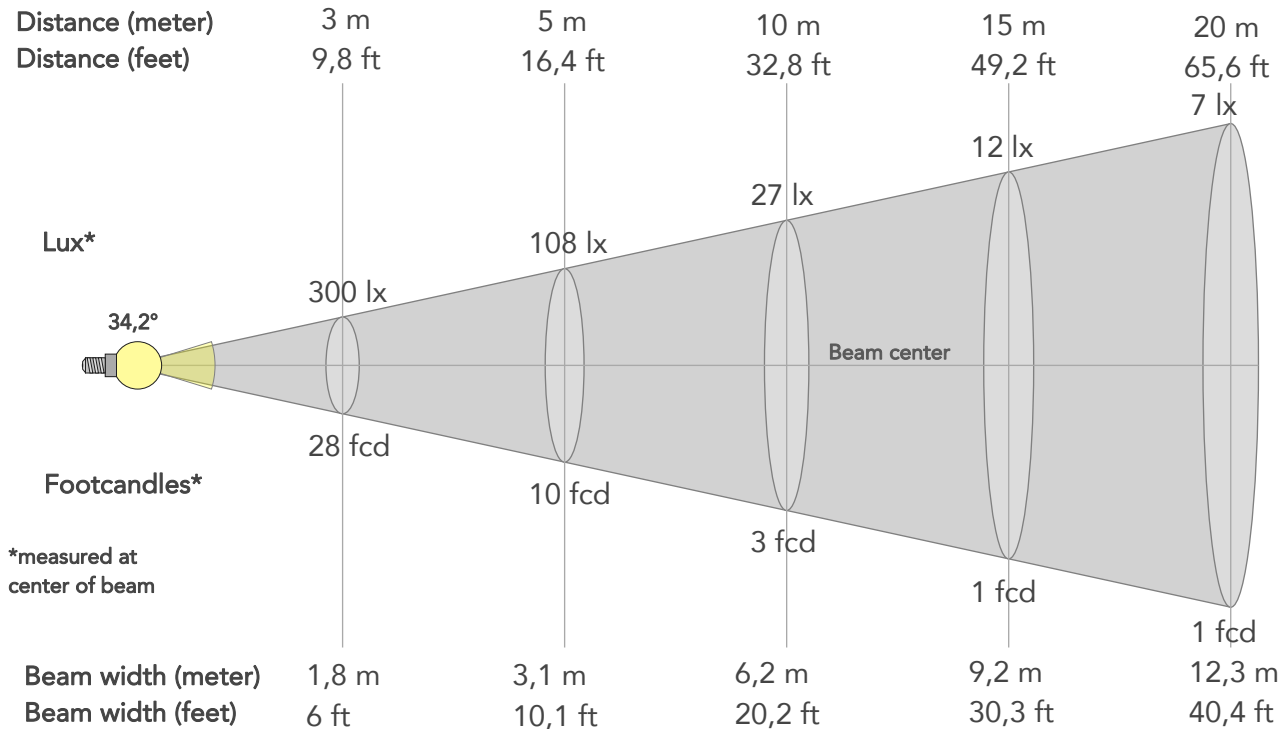

BEAM INTENSITIES AND WIDTHS

Distance	1m	2m	3m	4m	5m	7,5m	10m	15m	20m	25m	30m	40m	50m
Distance	3,3ft	6,6ft	9,8ft	13,1ft	16,4ft	24,6ft	32,8ft	49,2ft	65,6ft	82ft	98,4ft	131,2ft	164ft
Lux	2702lx	675lx	300lx	169lx	108lx	48lx	27lx	12lx	7lx	4lx	3lx	2lx	1lx
Footcand.	251fcd	63fcd	28fcd	16fcd	10fcd	4fcd	3fcd	1fcd	1fcd	0fcd	0fcd	0fcd	0fcd
Beam wid.	0,6m	1,2m	1,8m	2,5m	3,1m	4,6m	6,2m	9,2m	12,3m	15,4m	18,5m	24,6m	30,8m
Beam wid.	2ft	4,1ft	6ft	8,1ft	10,1ft	15,1ft	20,2ft	30,3ft	40,4ft	50,5ft	60,6ft	80,8ft	101ft

LINEAR DISTRIBUTION DIAGRAM

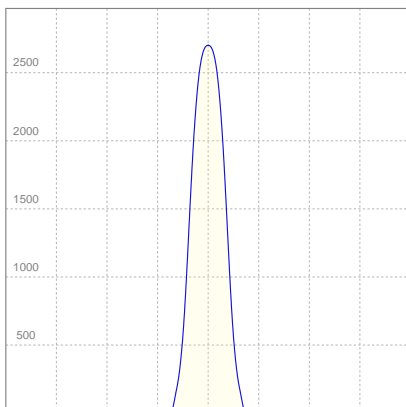

ELECTRICAL SPECIFICATIONS

Input voltage	Input current	Input power	Effeciency
222V	1,17A	231,5W	4lm/W

Power FC
0,89

ISO CANDELA DIAGRAM

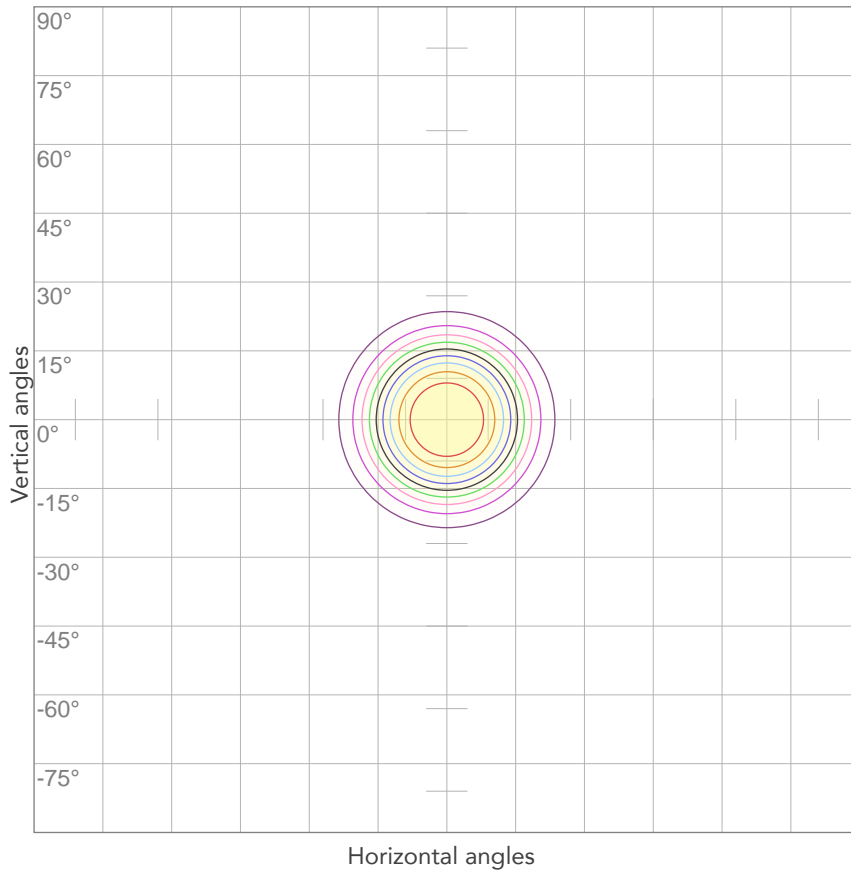

10%	270 cd
20%	540 cd
30%	810 cd
40%	1081 cd
50%	1351 cd
60%	1621 cd
70%	1891 cd
80%	2161 cd

Conditions:

Number of c-planes: 2

Candela at center: 2702 cd

ISO LUX DIAGRAM

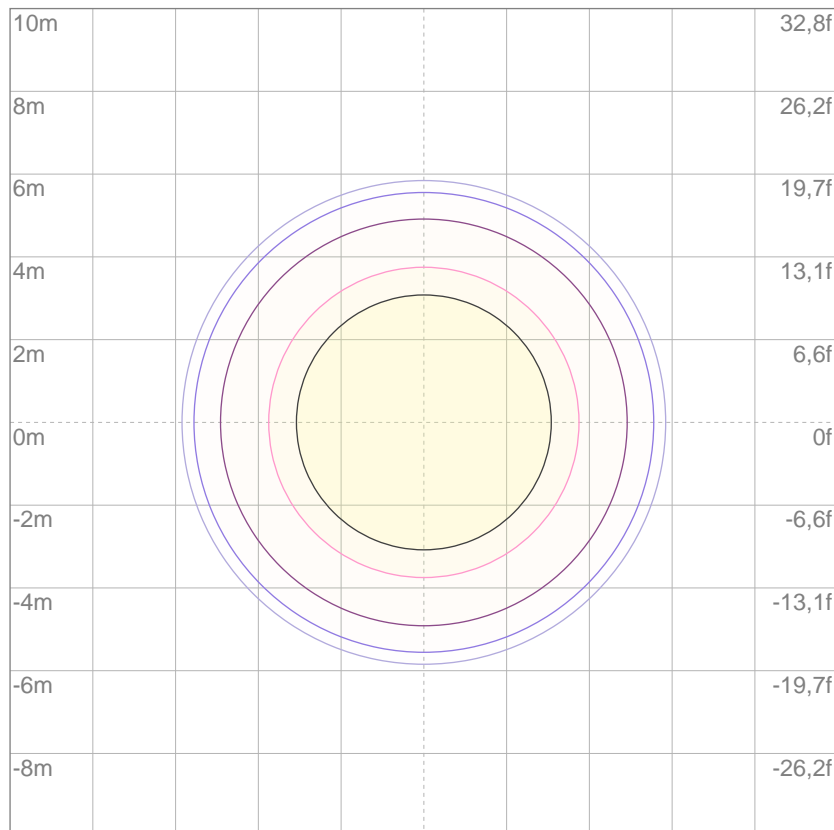

Mounting height: 10 meters (33 feet)

3%	0,810 lx
5%	1,35 lx
10%	2,70 lx
30%	8,10 lx
50%	13,5 lx

Conditions:

Number of c-planes: 2

Lux at center: 27,0 lx

Lux distribution on a surface when lamp is mounted at 10 meters from the surface.



Total lumen output:

753 lm

Peak candela output:

10158 cd

PRODUCT NAME:

ASTRAWASH19PIX

MEASUREMENT CONDITIONS:

Beam angle:

Med Zoom

Target:

Blue

Operator:

Paolo Carvone

Date and time:

15/02/2021 12:36:26

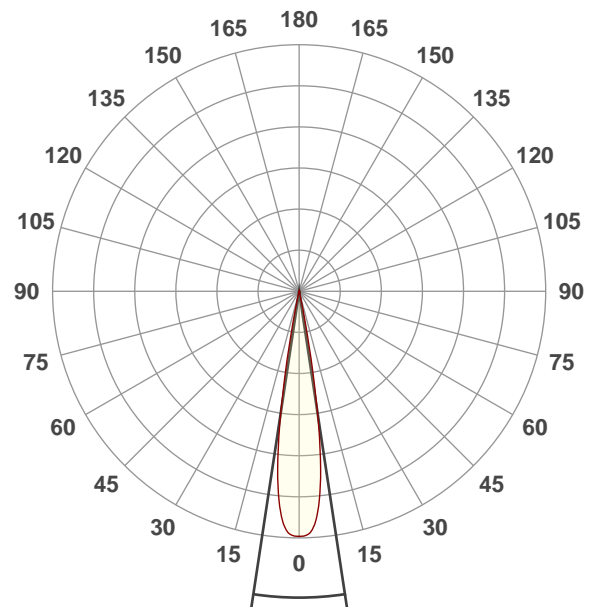

Beam angle 50%: 17,2°

Field angle 10%: 23,1°

Cut off angle 2.5%: 25,6°

Spectra

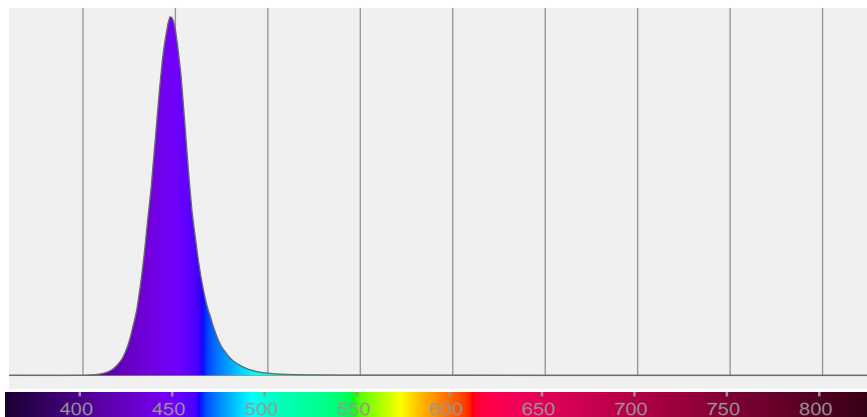

BEAM DETAILS



Beam angle 50%	Field angle 10%	Cut off angle 2,5%	Intensity ratio in 120° cone	Intensity ratio in 90° cone
17,2°	23,1°	25,6°	99,5%	99,1%

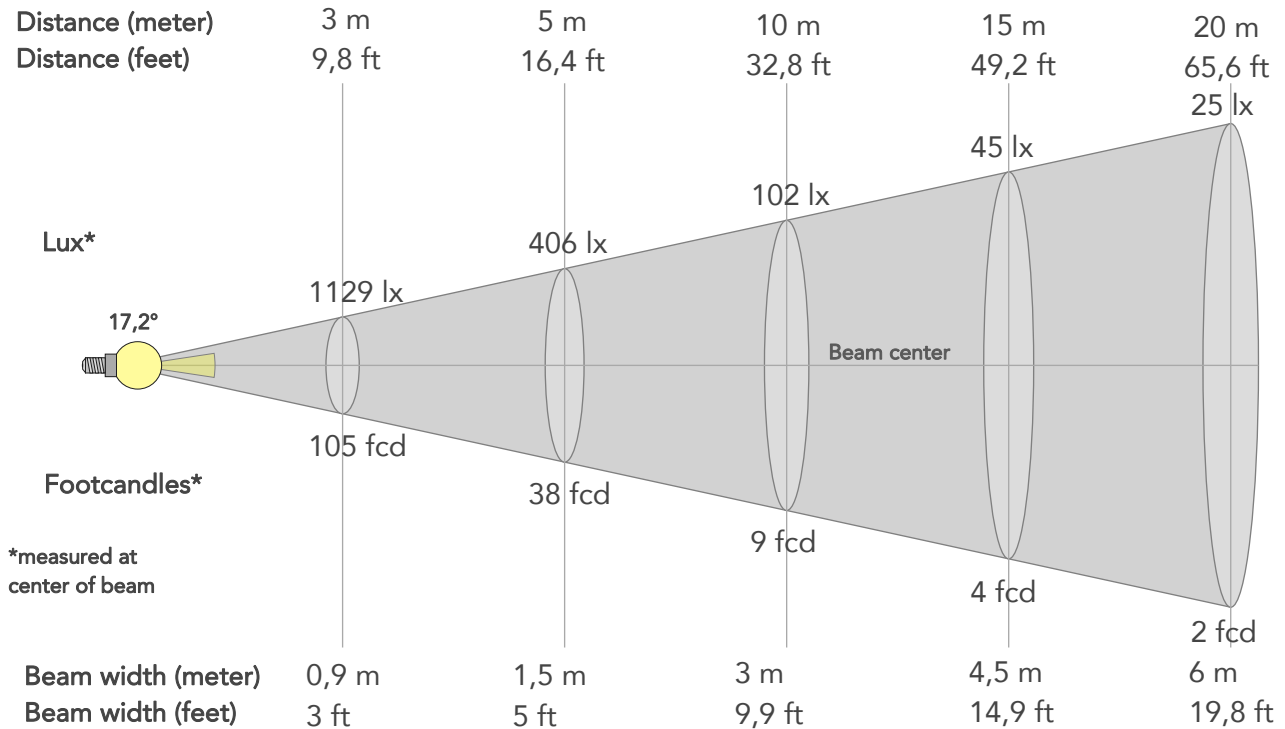

BEAM INTENSITIES AND WIDTHS

Distance	1m	2m	3m	4m	5m	7,5m	10m	15m	20m	25m	30m	40m	50m
Distance	3,3ft	6,6ft	9,8ft	13,1ft	16,4ft	24,6ft	32,8ft	49,2ft	65,6ft	82ft	98,4ft	131,2ft	164ft
Lux	10158lx	2540lx	1129lx	635lx	406lx	181lx	102lx	45lx	25lx	16lx	11lx	6lx	4lx
Footcand.	944fcd	236fcd	105fcd	59fcd	38fcd	17fcd	9fcd	4fcd	2fcd	2fcd	1fcd	1fcd	0fcd
Beam wid.	0,3m	0,6m	0,9m	1,2m	1,5m	2,3m	3m	4,5m	6m	7,6m	9,1m	12,1m	15,1m
Beam wid.	1ft	2ft	3ft	4ft	5ft	7,4ft	9,9ft	14,9ft	19,8ft	24,8ft	29,8ft	39,7ft	49,6ft

LINEAR DISTRIBUTION DIAGRAM

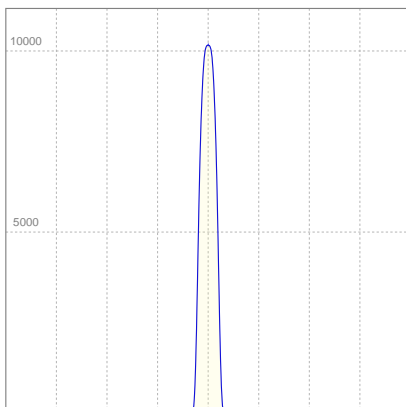

ELECTRICAL SPECIFICATIONS

Input voltage	Input current	Input power	Effeciency
222V	1,17A	230,9W	3lm/W

Power FC
0,89

ISO CANDELA DIAGRAM

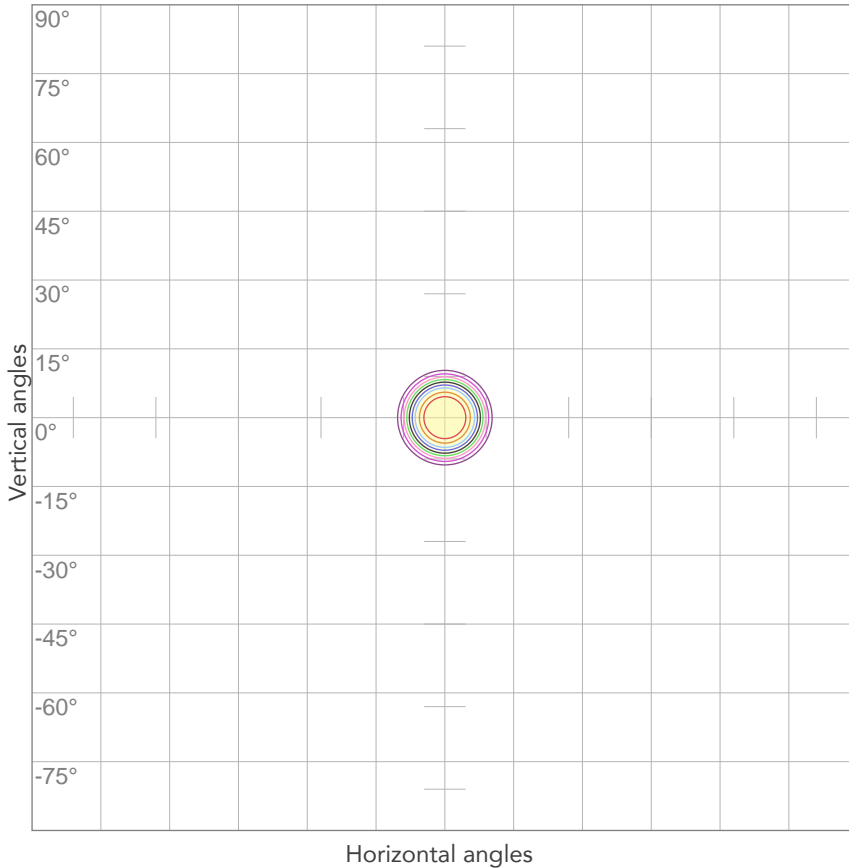

10%	1016 cd
20%	2032 cd
30%	3047 cd
40%	4063 cd
50%	5079 cd
60%	6095 cd
70%	7111 cd
80%	8127 cd

Conditions:

Number of c-planes: 2

Candela at center: 10158 cd

ISO LUX DIAGRAM

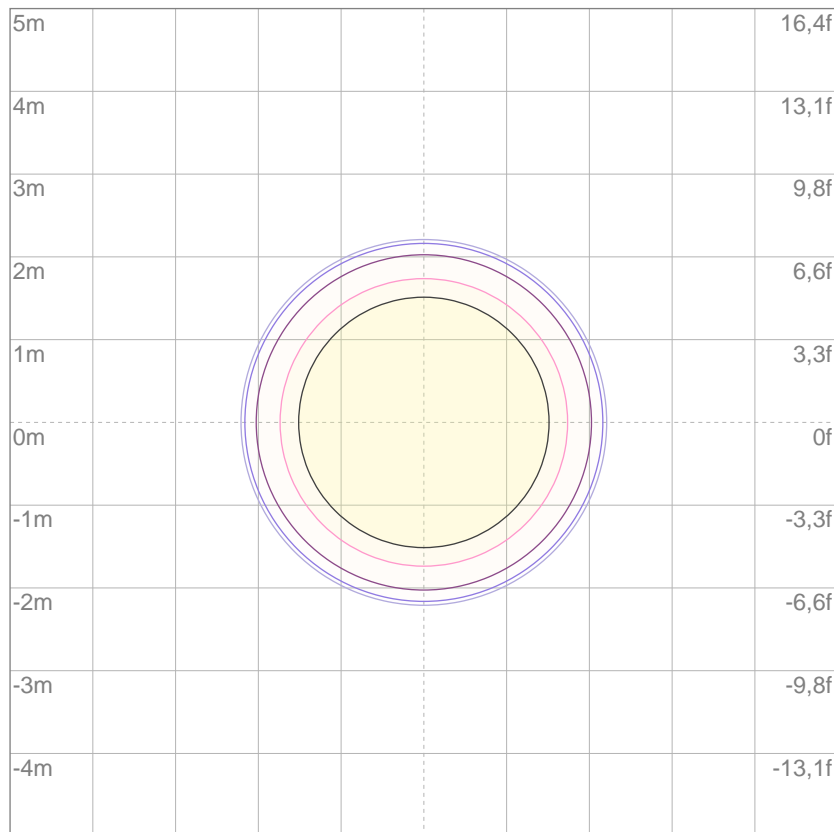

3%	3,05 lx
5%	5,08 lx
10%	10,2 lx
30%	30,5 lx
50%	50,8 lx

Conditions:

Number of c-planes: 2

Lux at center: 102 lx

Lux distribution on a surface when lamp is mounted at 10 meters from the surface.

Mounting height: 10 meters (33 feet)



Total lumen output:

486 lm

Peak candela output:

101763 cd

PRODUCT NAME:

ASTRAWASH19PIX

MEASUREMENT CONDITIONS:

Beam angle:

Min Zoom

Target:

Blue

Operator:

Paolo Carvone

Date and time:

15/02/2021 11:16:47

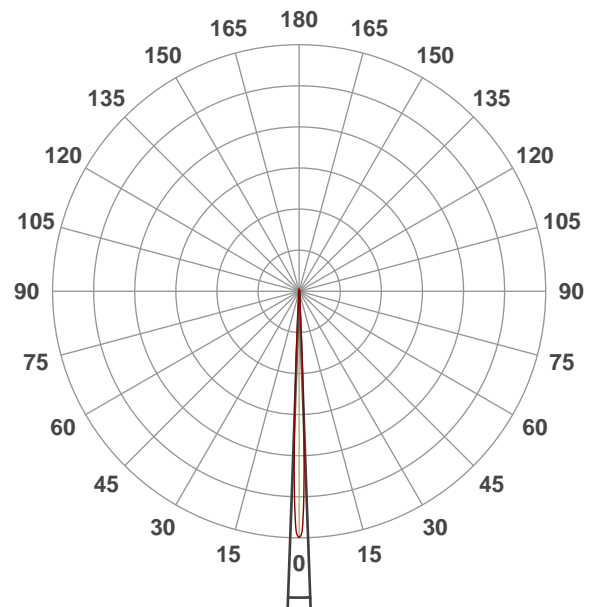

Beam angle 50%: 4,1°

Field angle 10%: 6,3°

Cut off angle 2.5%: 7,3°

Spectra

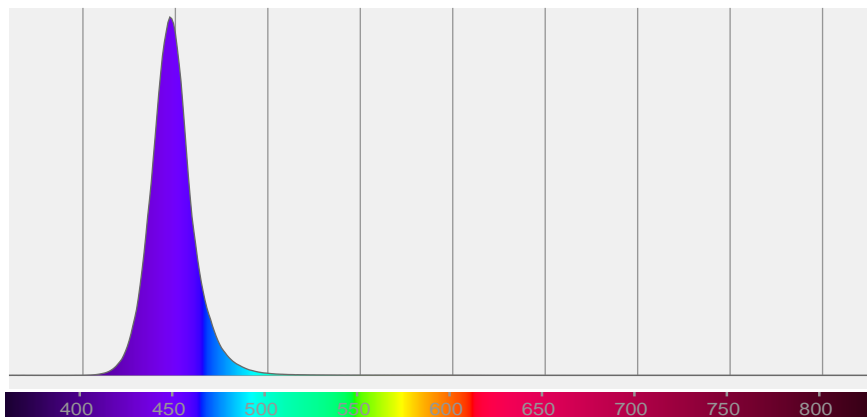

BEAM DETAILS



Beam angle 50%	Field angle 10%	Cut off angle 2,5%	Intensity ratio in 120° cone	Intensity ratio in 90° cone
4,1°	6,3°	7,3°	100,0%	99,9%

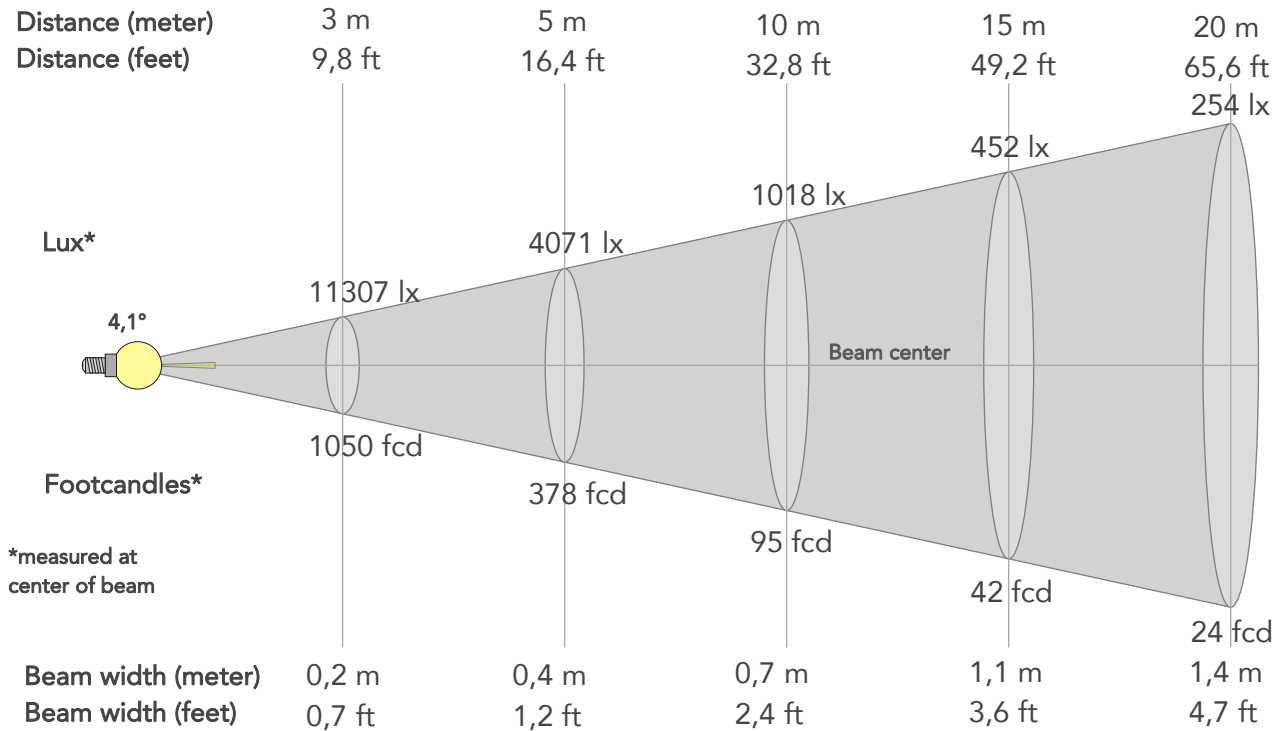

BEAM INTENSITIES AND WIDTHS

Distance	1m	2m	3m	4m	5m	7,5m	10m	15m	20m	25m	30m	40m	50m
Distance	3,3ft	6,6ft	9,8ft	13,1ft	16,4ft	24,6ft	32,8ft	49,2ft	65,6ft	82ft	98,4ft	131,2ft	164ft
Lux	101763lx	25441lx	11307lx	6360lx	4071lx	1809lx	1018lx	452lx	254lx	163lx	113lx	64lx	41lx
Footcand.	9454fcd	2364fcd	1050fcd	591fcd	378fcd	168fcd	95fcd	42fcd	24fcd	15fcd	11fcd	6fcd	4fcd
Beam wid.	0,1m	0,1m	0,2m	0,3m	0,4m	0,5m	0,7m	1,1m	1,4m	1,8m	2,2m	2,9m	3,6m
Beam wid.	0,2ft	0,5ft	0,7ft	0,9ft	1,2ft	1,8ft	2,4ft	3,6ft	4,7ft	5,9ft	7,1ft	9,5ft	11,9ft

LINEAR DISTRIBUTION DIAGRAM

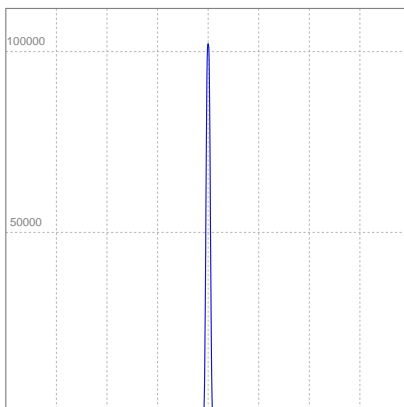

ELECTRICAL SPECIFICATIONS

Input voltage	Input current	Input power	Effeciency
224V	1,18A	232,3W	2lm/W

Power FC
0,88

ISO CANDELA DIAGRAM

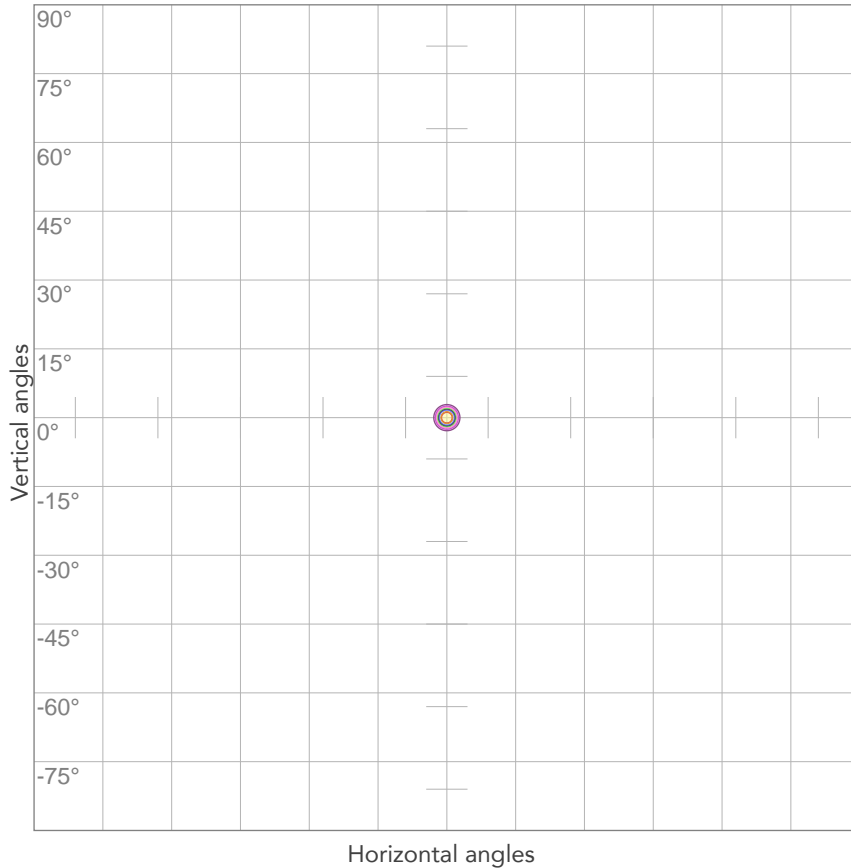

10%	10176 cd
20%	20353 cd
30%	30529 cd
40%	40705 cd
50%	50881 cd
60%	61058 cd
70%	71234 cd
80%	81410 cd

Conditions:
 Number of c-planes: 2
 Candela at center: 101763 cd

ISO LUX DIAGRAM

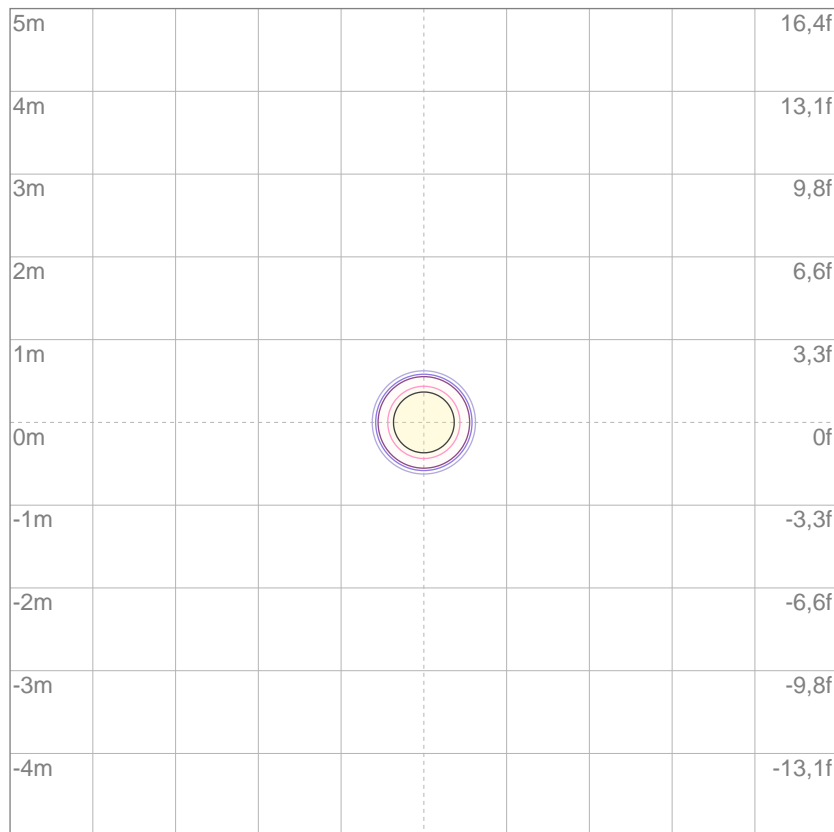

3%	30,5 lx
5%	50,9 lx
10%	102 lx
30%	305 lx
50%	509 lx

Conditions:
 Number of c-planes: 2
 Lux at center: 1018 lx

Lux distribution on a surface when lamp is mounted at 10 meters from the surface.

Mounting height: 10 meters (33 feet)



Total lumen output:

5302 lm

Peak candela output:

14647 cd

PRODUCT NAME:

ASTRAWASH19PIX

MEASUREMENT CONDITIONS:

Beam angle:

Max Zoom

Target:

Blue

Operator:

Paolo Carvone

Date and time:

15/02/2021 13:01:35

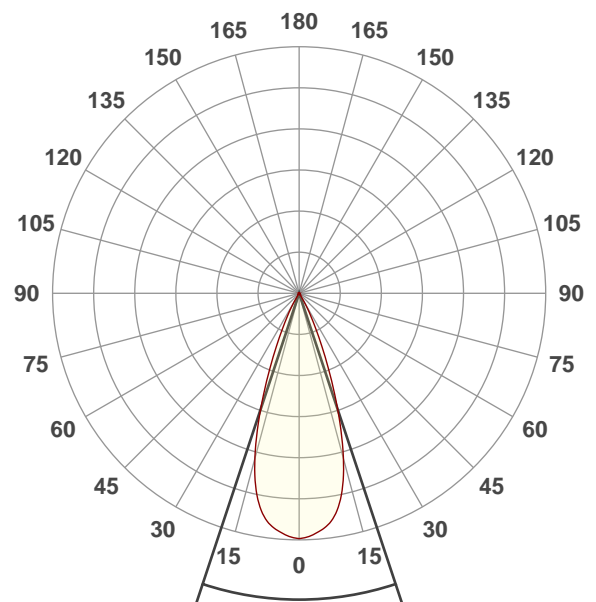

Beam angle 50%: 36,7°

Field angle 10%: 54,7°

Cut off angle 2.5%: 62,8°

Spectra

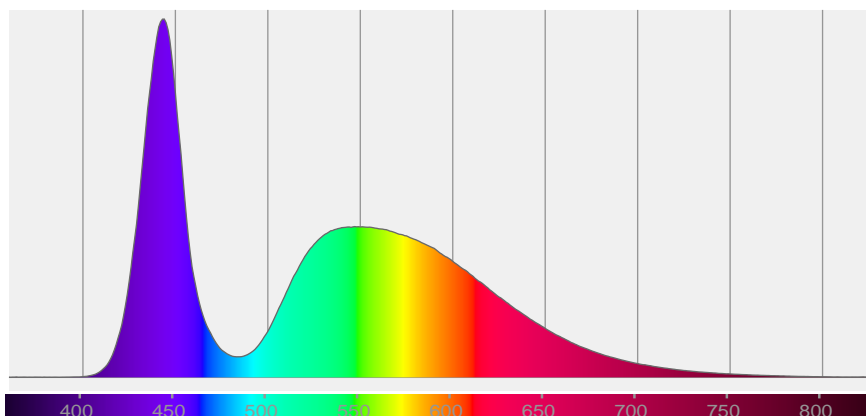

BEAM DETAILS



Beam angle 50%	Field angle 10%	Cut off angle 2,5%	Intensity ratio in 120° cone	Intensity ratio in 90° cone
36,7°	54,7°	62,8°	100,0%	99,9%

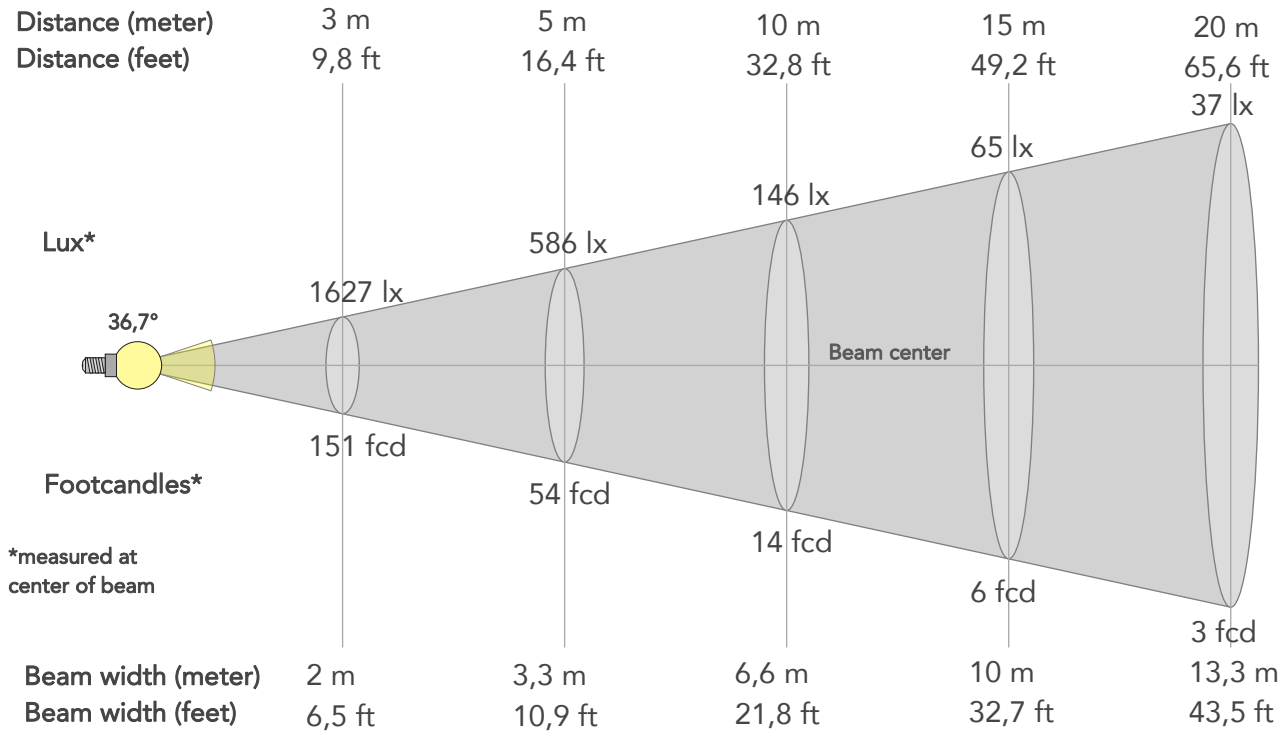

BEAM INTENSITIES AND WIDTHS

Distance	1m	2m	3m	4m	5m	7,5m	10m	15m	20m	25m	30m	40m	50m
Distance	3,3ft	6,6ft	9,8ft	13,1ft	16,4ft	24,6ft	32,8ft	49,2ft	65,6ft	82ft	98,4ft	131,2ft	164ft
Lux	14647lx	3662lx	1627lx	915lx	586lx	260lx	146lx	65lx	37lx	23lx	16lx	9lx	6lx
Footcand.	1361fcd	340fcd	151fcd	85fcd	54fcd	24fcd	14fcd	6fcd	3fcd	2fcd	2fcd	1fcd	1fcd
Beam wid.	0,7m	1,3m	2m	2,7m	3,3m	5m	6,6m	10m	13,3m	16,6m	19,9m	26,5m	33,2m
Beam wid.	2,2ft	4,4ft	6,5ft	8,7ft	10,9ft	16,3ft	21,8ft	32,7ft	43,5ft	54,4ft	65,3ft	87,1ft	108,9ft

LINEAR DISTRIBUTION DIAGRAM

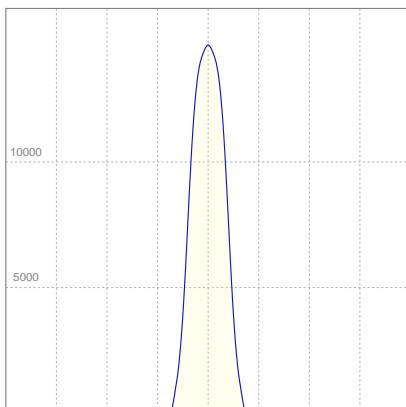

ELECTRICAL SPECIFICATIONS

Input voltage	Input current	Input power	Effeciency
223V	1,19A	234,3W	23lm/W

Power FC
0,88

ISO CANDELA DIAGRAM

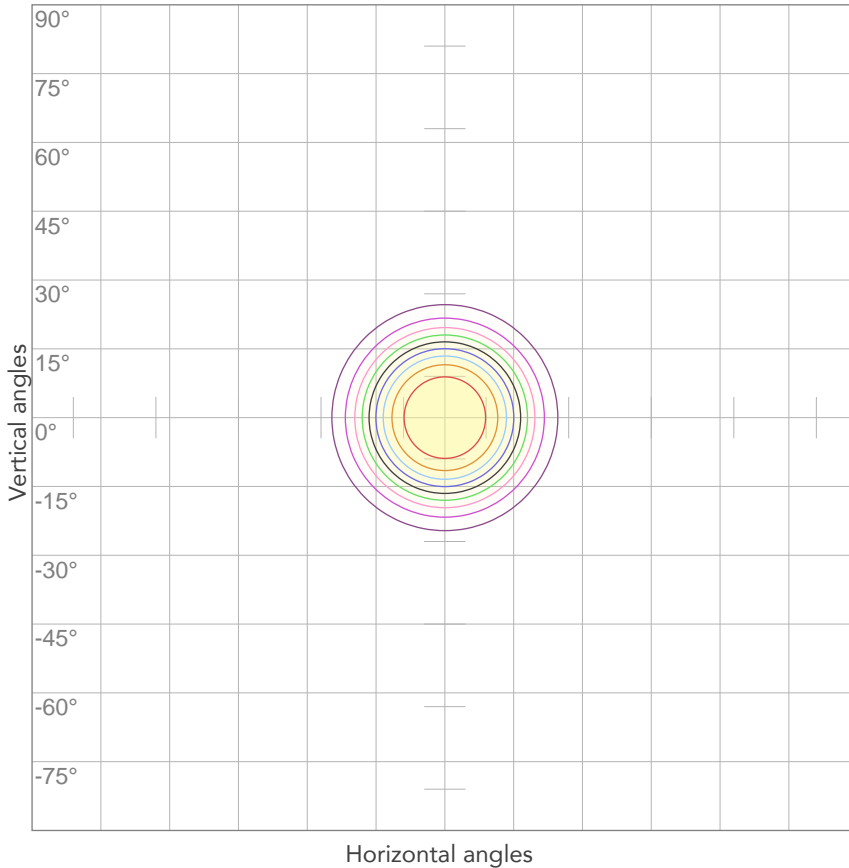

10%	1465 cd
20%	2929 cd
30%	4394 cd
40%	5859 cd
50%	7324 cd
60%	8788 cd
70%	10253 cd
80%	11718 cd

Conditions:

Number of c-planes: 2

Candela at center: 14647 cd

ISO LUX DIAGRAM

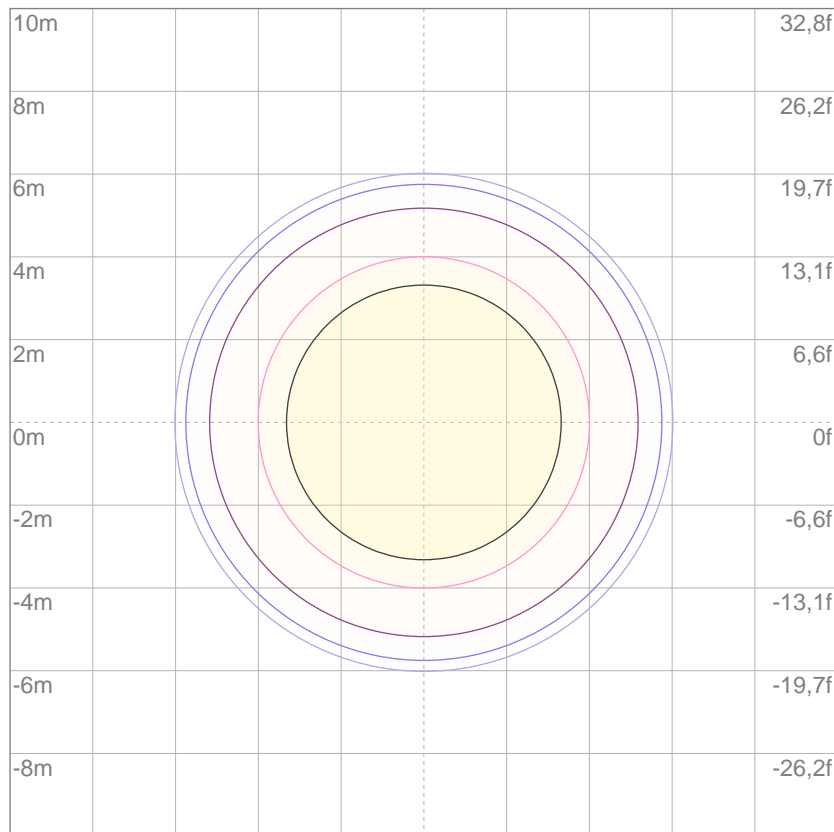

3%	4,39 lx
5%	7,32 lx
10%	14,6 lx
30%	43,9 lx
50%	73,2 lx

Conditions:

Number of c-planes: 2

Lux at center: 146 lx

Lux distribution on a surface when lamp is mounted at 10 meters from the surface.

Mounting height: 10 meters (33 feet)



Total lumen output:

4466 lm

Peak candela output:

53457 cd

PRODUCT NAME:

ASTRAWASH19PIX

MEASUREMENT CONDITIONS:

Beam angle:

Med Zoom

Target:

Blue

Operator:

Paolo Carvone

Date and time:

15/02/2021 13:00:06

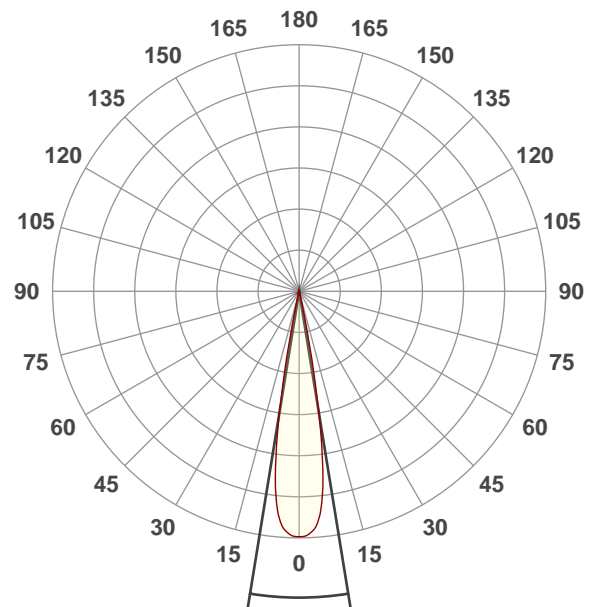

Beam angle 50%: 18,4°

Field angle 10%: 24,3°

Cut off angle 2.5%: 26,6°

Spectra

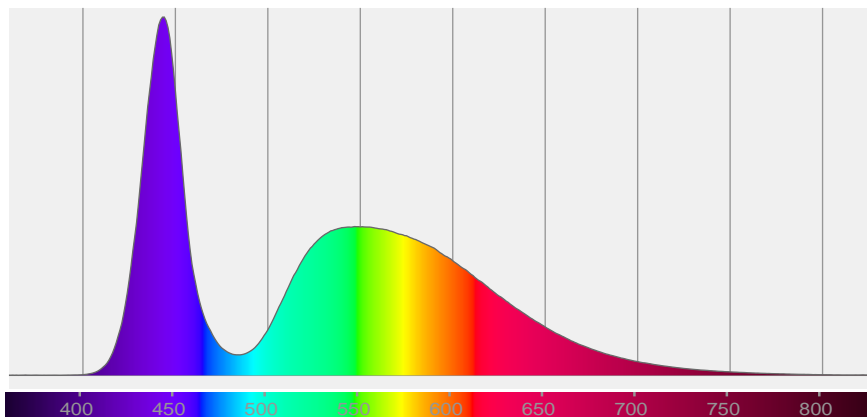

BEAM DETAILS



Beam angle 50%	Field angle 10%	Cut off angle 2,5%	Intensity ratio in 120° cone	Intensity ratio in 90° cone
18,4°	24,3°	26,6°	100,0%	100,0%

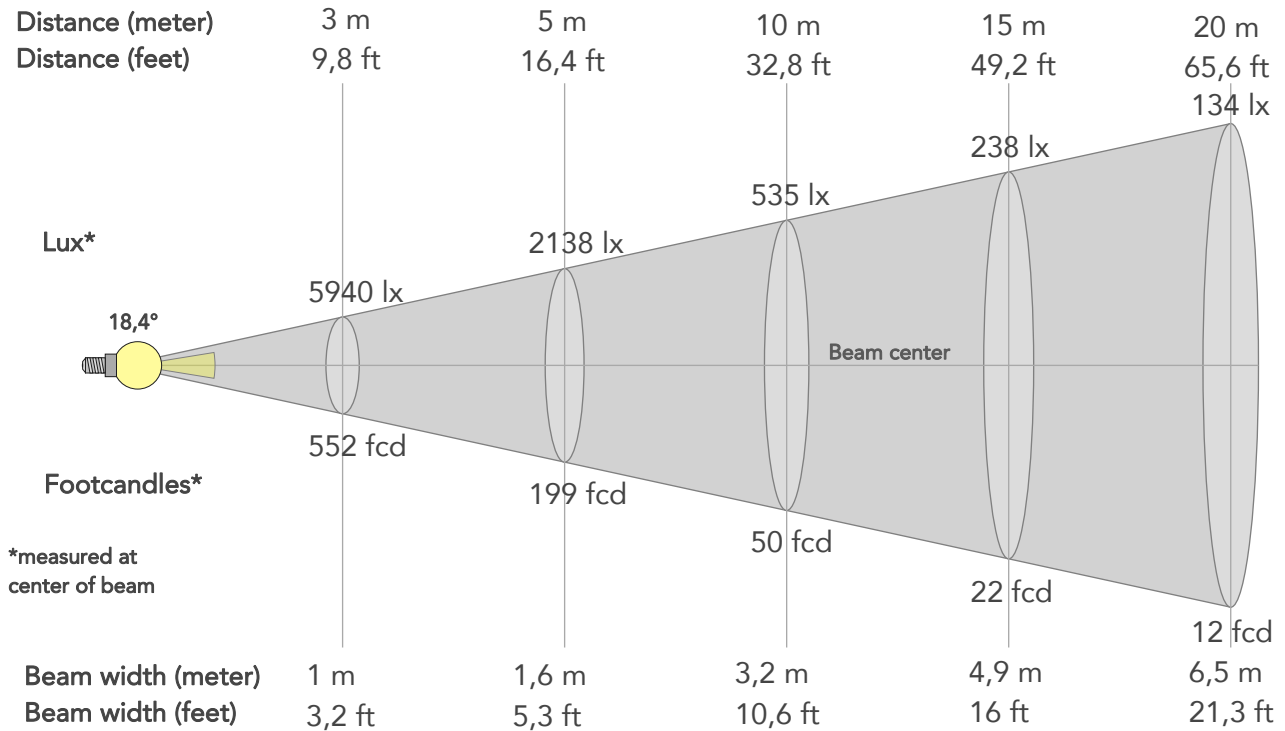

BEAM INTENSITIES AND WIDTHS

Distance	1m	2m	3m	4m	5m	7,5m	10m	15m	20m	25m	30m	40m	50m
Distance	3,3ft	6,6ft	9,8ft	13,1ft	16,4ft	24,6ft	32,8ft	49,2ft	65,6ft	82ft	98,4ft	131,2ft	164ft
Lux	53457lx	13364lx	5940lx	3341lx	2138lx	950lx	535lx	238lx	134lx	86lx	59lx	33lx	21lx
Footcand.	4966fcd	1242fcd	552fcd	310fcd	199fcd	88fcd	50fcd	22fcd	12fcd	8fcd	6fcd	3fcd	2fcd
Beam wid.	0,3m	0,6m	1m	1,3m	1,6m	2,4m	3,2m	4,9m	6,5m	8,1m	9,7m	13m	16,2m
Beam wid.	1,1ft	2,1ft	3,2ft	4,3ft	5,3ft	8ft	10,6ft	16ft	21,3ft	26,6ft	31,9ft	42,6ft	53,2ft

LINEAR DISTRIBUTION DIAGRAM

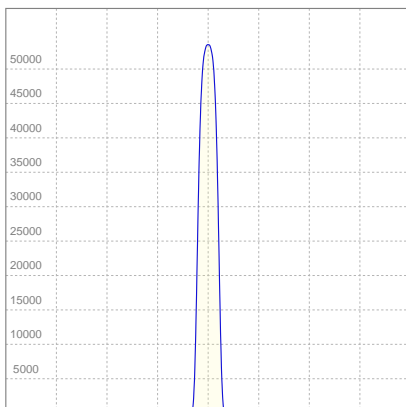

ELECTRICAL SPECIFICATIONS

Input voltage	Input current	Input power	Effeciency
227V	1,17A	233,9W	19lm/W

Power FC
0,88

ISO CANDELA DIAGRAM

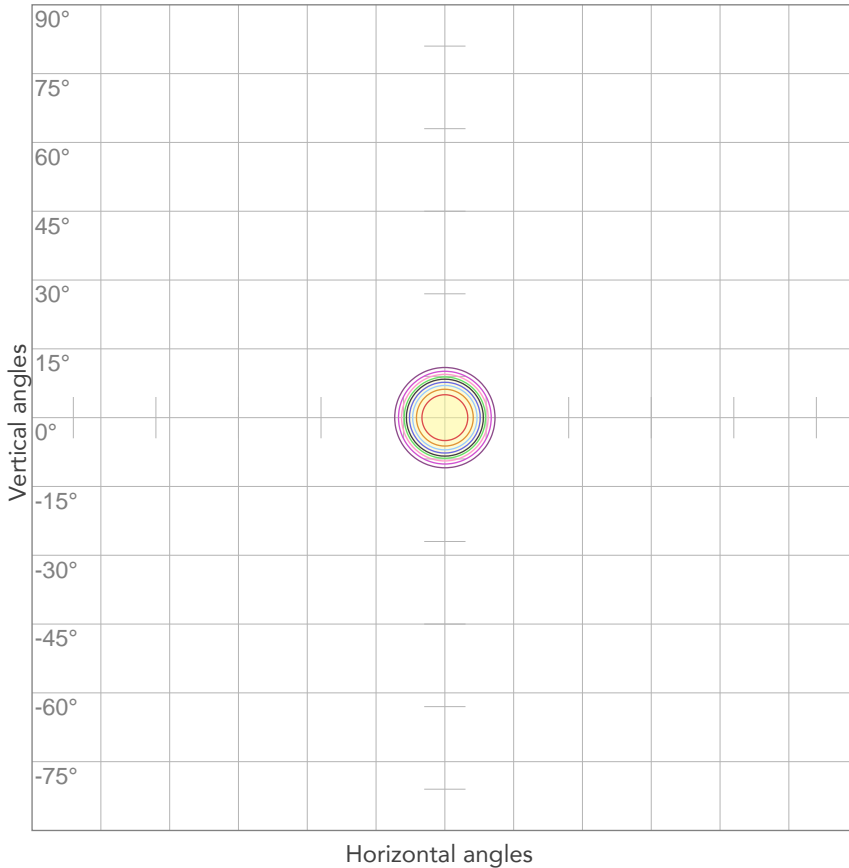

10%	5346 cd
20%	10691 cd
30%	16037 cd
40%	21383 cd
50%	26728 cd
60%	32074 cd
70%	37420 cd
80%	42766 cd

Conditions:

Number of c-planes: 2

Candela at center: 53457 cd

ISO LUX DIAGRAM

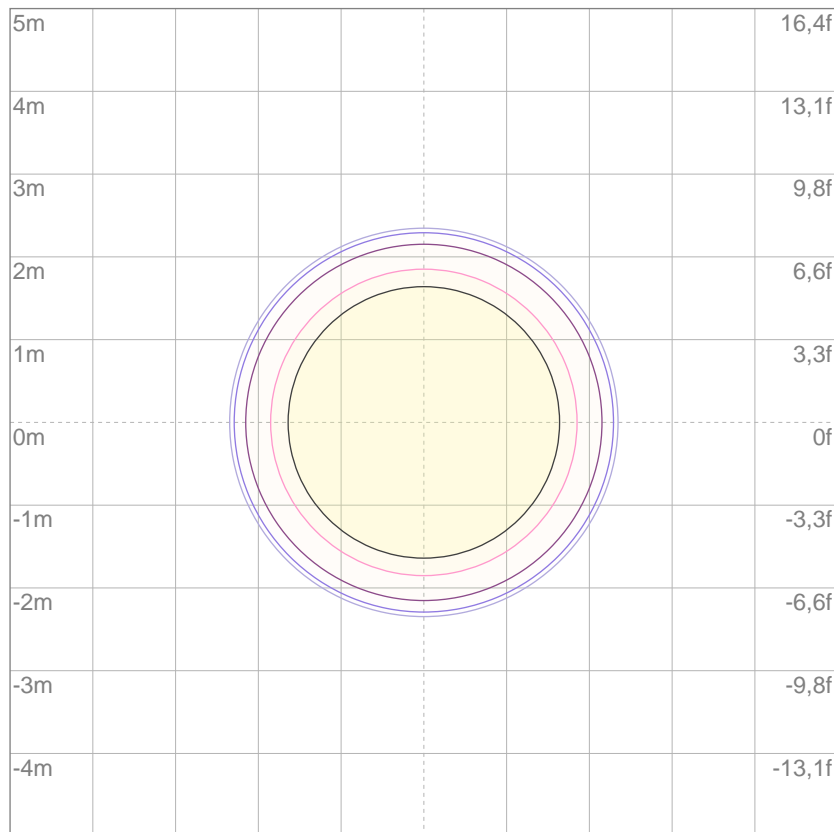

3%	16,0 lx
5%	26,7 lx
10%	53,5 lx
30%	160 lx
50%	267 lx

Conditions:

Number of c-planes: 2

Lux at center: 535 lx

Lux distribution on a surface when lamp is mounted at 10 meters from the surface.

Mounting height: 10 meters (33 feet)



Total lumen output:

2840 lm

Peak candela output:

586272 cd

PRODUCT NAME:

ASTRAWASH19PIX

MEASUREMENT CONDITIONS:

Beam angle:

Min Zoom

Target:

Blue

Operator:

Paolo Carvone

Date and time:

15/02/2021 11:18:46

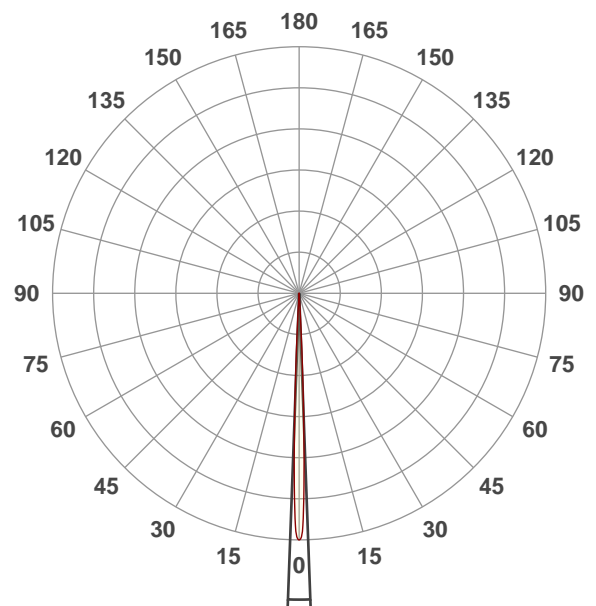

Beam angle 50%: 4,2°

Field angle 10%: 6,4°

Cut off angle 2.5%: 7,2°

Spectra

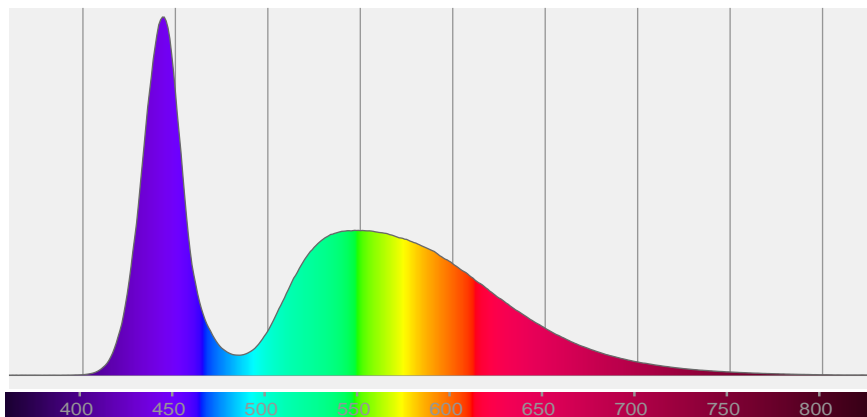

BEAM DETAILS



Beam angle 50%	Field angle 10%	Cut off angle 2,5%	Intensity ratio in 120° cone	Intensity ratio in 90° cone
4,2°	6,4°	7,2°	100,0%	100,0%

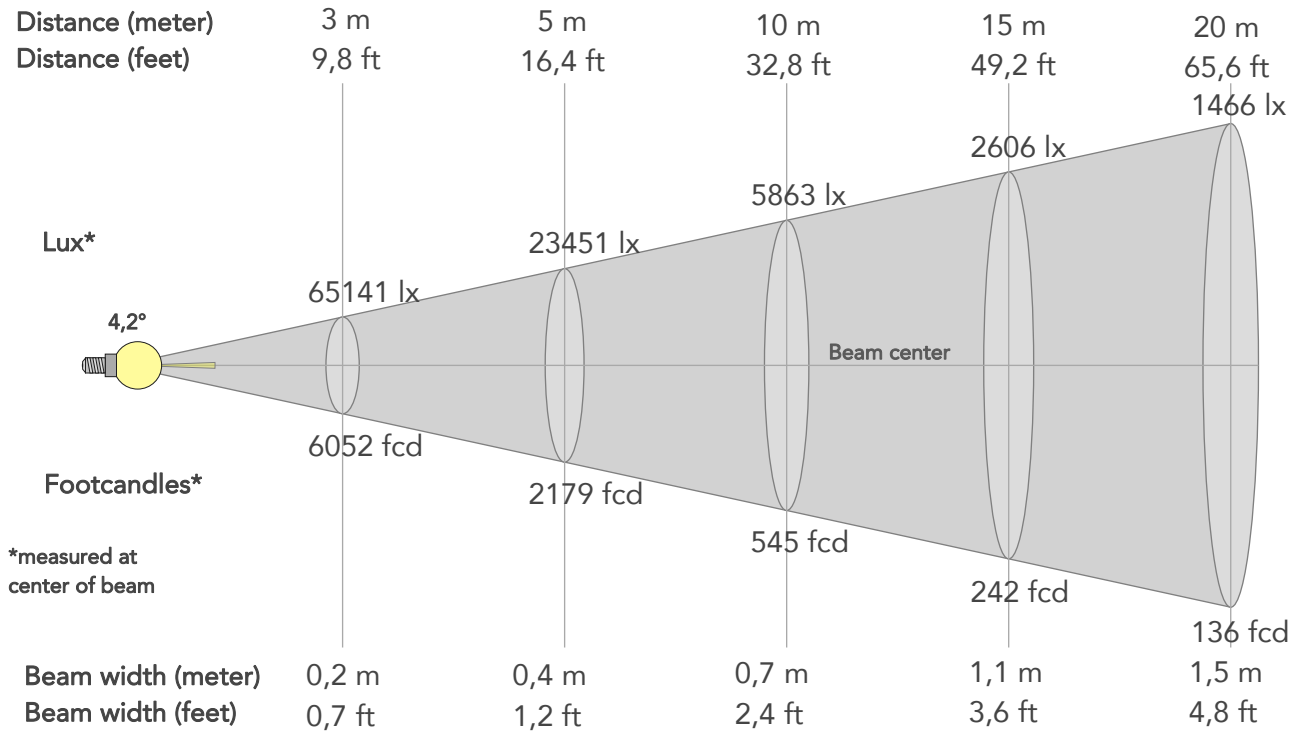

BEAM INTENSITIES AND WIDTHS

Distance	1m	2m	3m	4m	5m	7,5m	10m	15m	20m	25m	30m	40m	50m
Distance	3,3ft	6,6ft	9,8ft	13,1ft	16,4ft	24,6ft	32,8ft	49,2ft	65,6ft	82ft	98,4ft	131,2ft	164ft
Lux	586272lx	146568lx	65141lx	36642lx	23451lx	10423lx	5863lx	2606lx	1466lx	938lx	651lx	366lx	235lx
Footcand.	54466fcd	13617fcd	6052fcd	3404fcd	2179fcd	968fcd	545fcd	242fcd	136fcd	87fcd	61fcd	34fcd	22fcd
Beam wid.	0,1m	0,1m	0,2m	0,3m	0,4m	0,5m	0,7m	1,1m	1,5m	1,8m	2,2m	2,9m	3,7m
Beam wid.	0,2ft	0,5ft	0,7ft	1ft	1,2ft	1,8ft	2,4ft	3,6ft	4,8ft	6ft	7,2ft	9,6ft	12ft

LINEAR DISTRIBUTION DIAGRAM

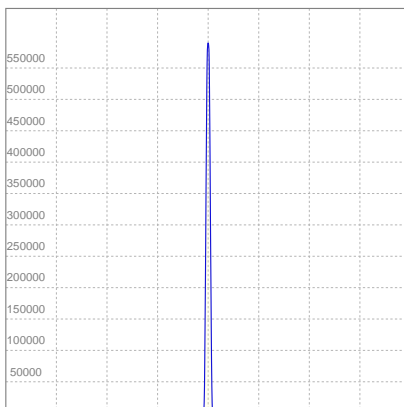

ELECTRICAL SPECIFICATIONS

Input voltage	Input current	Input power	Effeciency
223V	1,19A	234,8W	12lm/W

Power FC
0,88

ISO CANDELA DIAGRAM

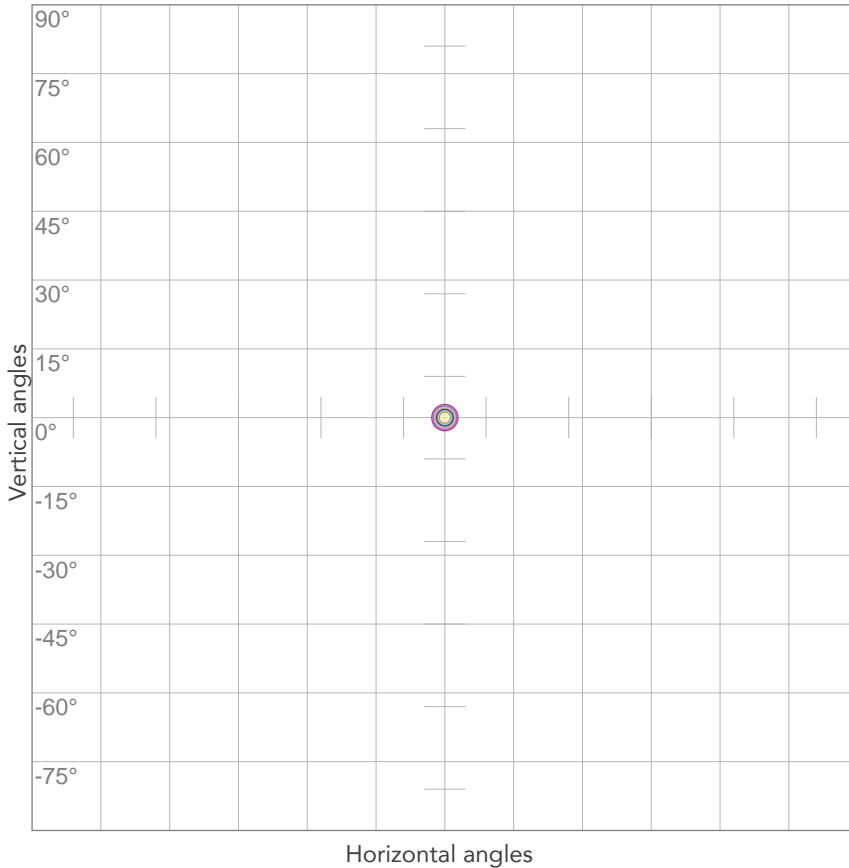

10%	58627 cd
20%	117254 cd
30%	175881 cd
40%	234509 cd
50%	293136 cd
60%	351763 cd
70%	410390 cd
80%	469017 cd

Conditions:

Number of c-planes: 2

Candela at center: 586272 cd

ISO LUX DIAGRAM

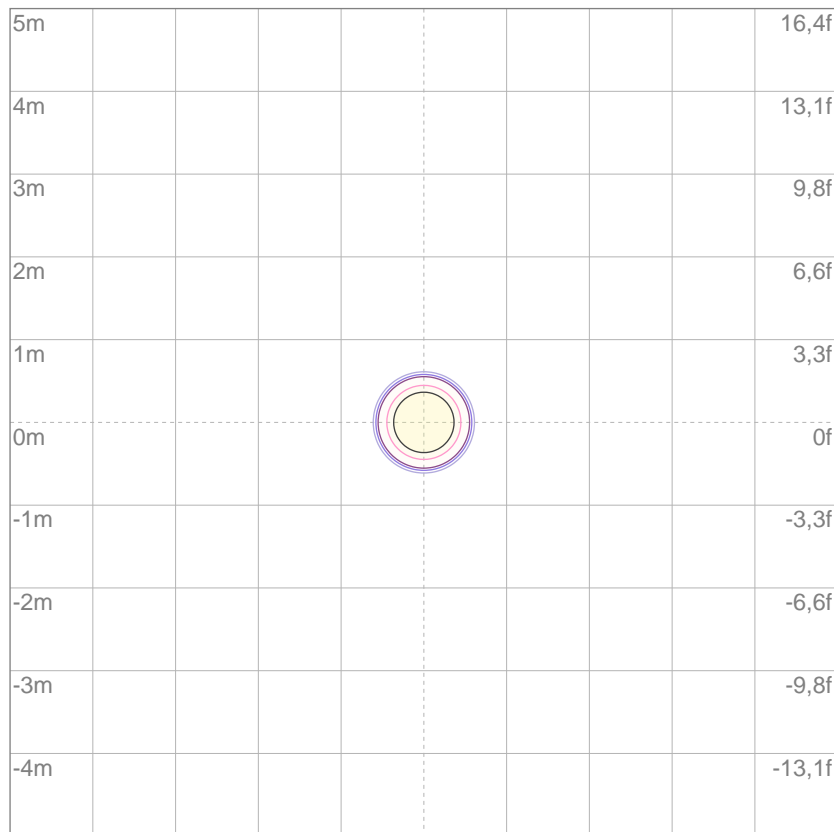

3%	176 lx
5%	293 lx
10%	586 lx
30%	1759 lx
50%	2931 lx

Conditions:

Number of c-planes: 2

Lux at center: 5863 lx

Lux distribution on a surface when lamp is mounted at 10 meters from the surface.

Mounting height: 10 meters (33 feet)



Total lumen output:

6221 lm

Peak candela output:

18253 cd

Light quality:

CRI: 41,7

Color temperature:

2873 K

PRODUCT NAME:

ASTRAWASH19PIX

MEASUREMENT CONDITIONS:

Beam angle:

Max Zoom

Target:

2800K

Operator:

Paolo Carvone

Date and time:

15/02/2021 12:05:51

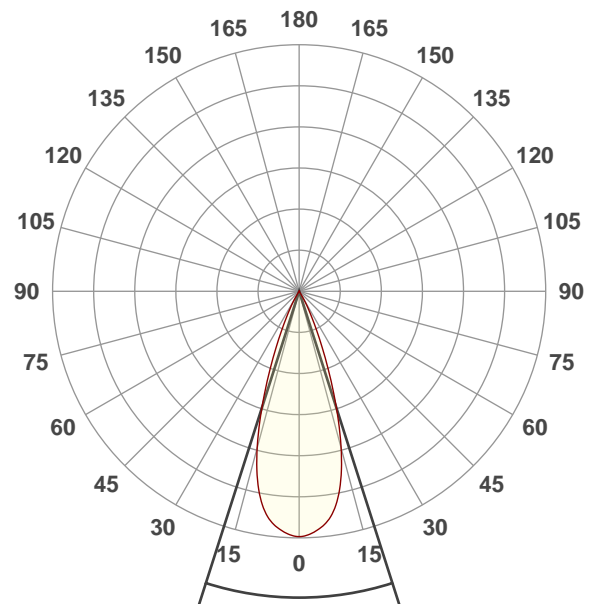

Beam angle 50%: 35,5°

Field angle 10%: 53,5°

Cut off angle 2.5%: 61,9°

Spectra

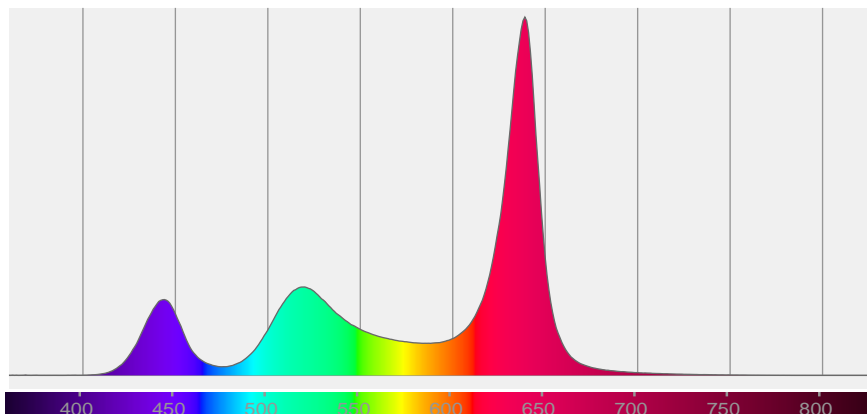

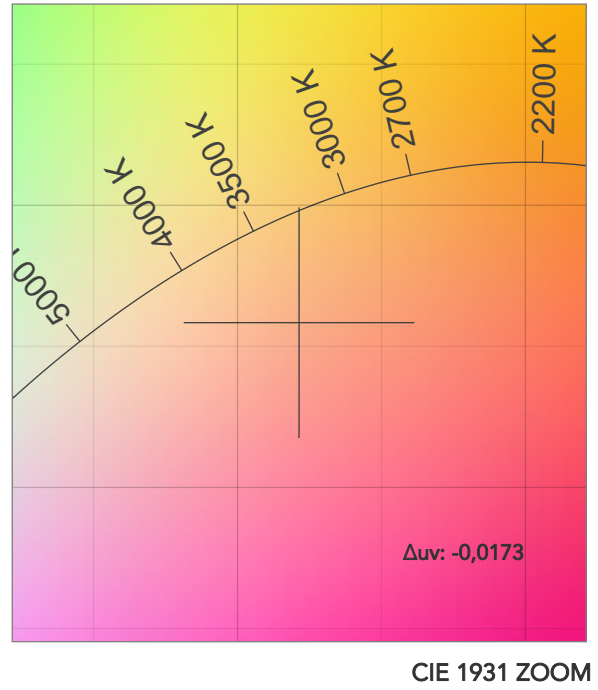
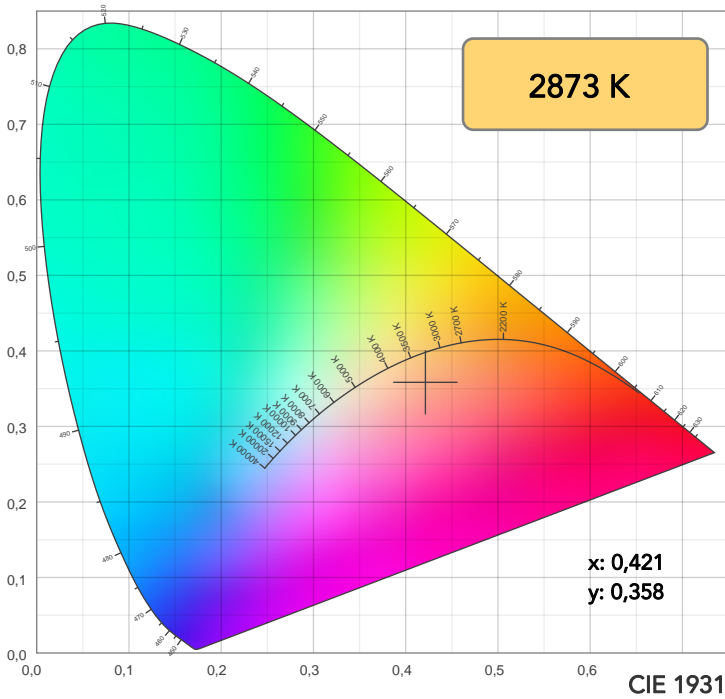

TM30: 59,4

CRI: 41,7 (R1-R8)

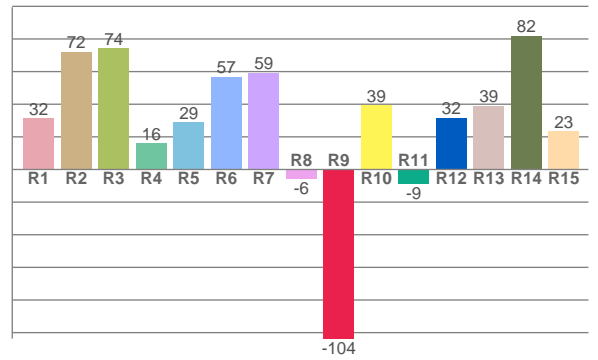
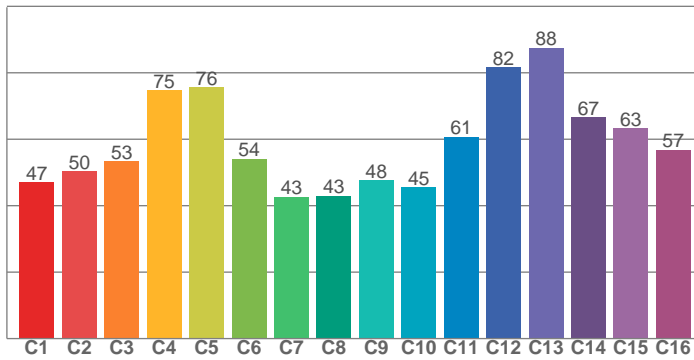

CRI R values, only R1-R8 are used to calculate final CRI value

R1	R2	R3	R4	R5	R6	R7	R8	R9	R10	R11	R12	R13	R14	R15
31,6	72,1	74,4	16,0	28,9	56,8	59,3	-5,9	-103,7	39,5	-8,8	31,8	39,2	81,9	23,3

TM30 C values, 16 binned values out of total of 99 C values

C1	C2	C3	C4	C5	C6	C7	C8	C9	C10	C11	C12	C13	C14	C15	C16
47,0	50,4	53,3	74,7	75,6	54,1	42,7	42,9	47,6	45,5	60,8	81,7	87,5	66,5	63,3	56,7

CQS Q values

Q1	Q2	Q3	Q4	Q5	Q6	Q7	Q8	Q9	Q10	Q11	Q12	Q13	Q14	Q15
79,7	93,0	82,1	51,1	45,3	51,0	87,1	77,8	85,0	89,1	67,7	60,7	63,5	79,7	82,5

CQS: 69,0

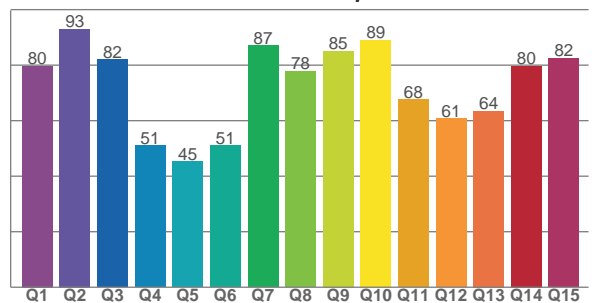

COLOR PARAMETERS

Color temperature	Color rendering index	Red component	Color fidelity	Color gamut	Color quality scale	Television lighting index	Color coordinate cie 1931	Color coordinate cie 1931	Color deviation from black body
CCT	CRI	CRI R9	TM30 Rf	TM30 Rg	CQS	TLCI	x	y	Δuv
2873 K	41,7	-103,7	59,4	130,1	69,0	25	0,421	0,358	-0,0173

TM30 DETAILS

Rf 59,4
Fidelity index Rf

Rg 130,1
Gammut index

Hue Bin	R _f	Graphic shifts (%)	
		Chroma	Hue
1	47	24%	-5%
2	50	20%	-14%
3	53	13%	-15%
4	75	10%	-4%
5	76	14%	8%
6	54	24%	15%
7	43	33%	4%
8	43	30%	-14%
9	48	21%	-21%
10	45	8%	-31%
11	61	0%	-26%
12	82	-1%	-8%
13	88	4%	5%
14	67	3%	23%
15	63	17%	12%
16	57	26%	11%

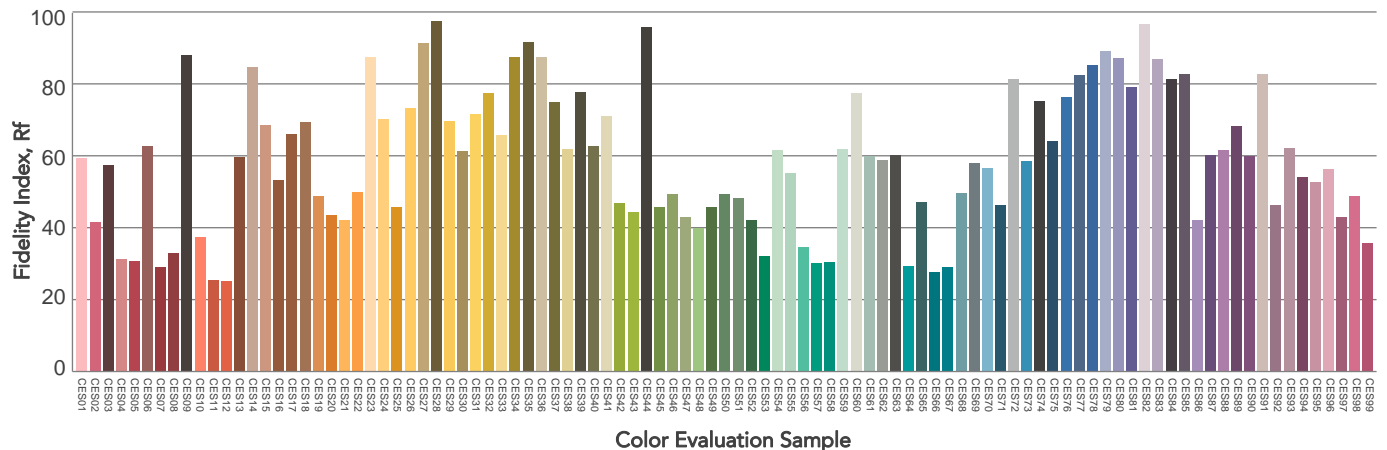
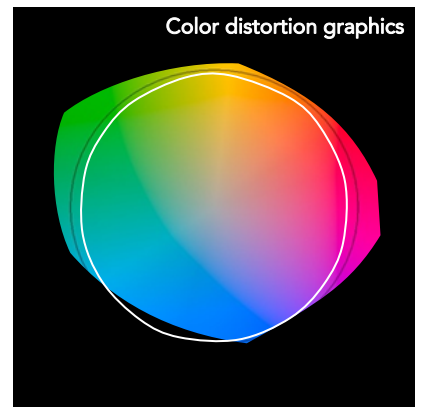
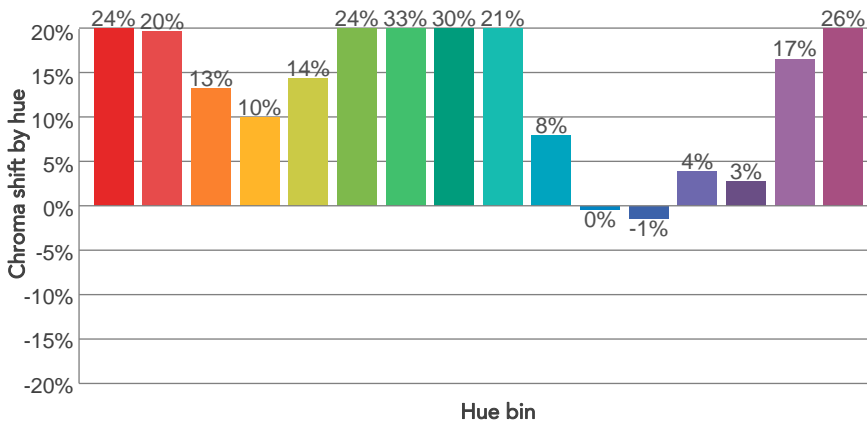
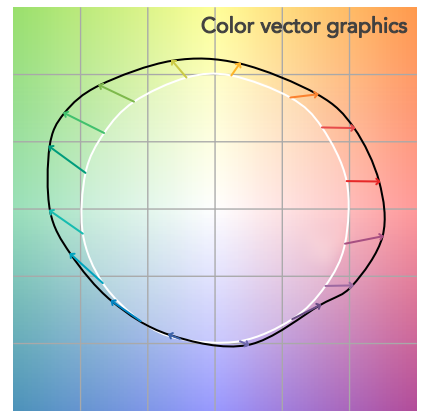
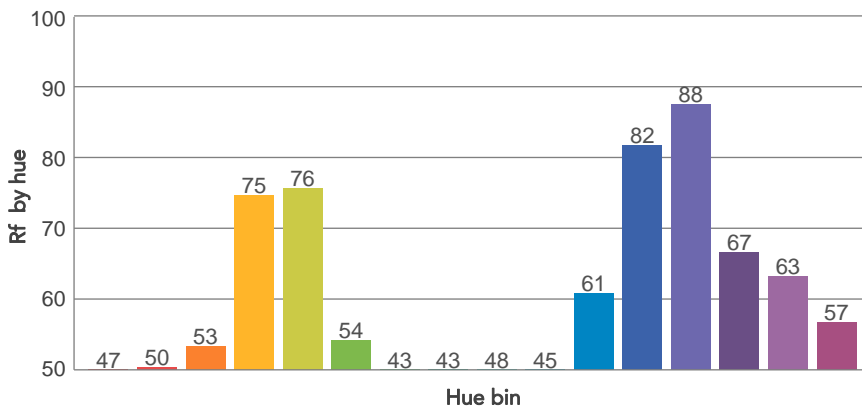
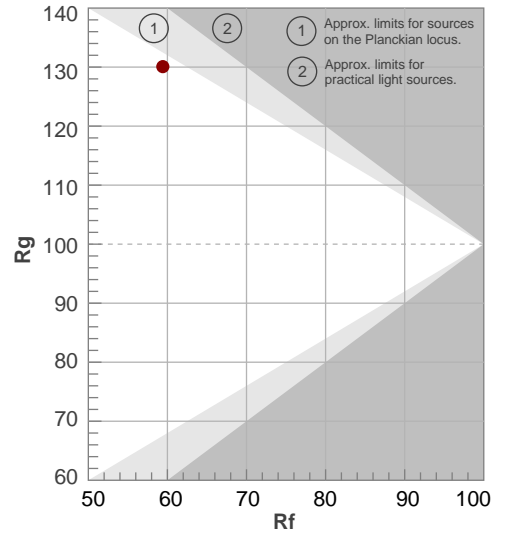

BEAM DETAILS



Beam angle 50%	Field angle 10%	Cut off angle 2,5%	Intensity ratio in 120° cone	Intensity ratio in 90° cone
35,5°	53,5°	61,9°	100,0%	100,0%

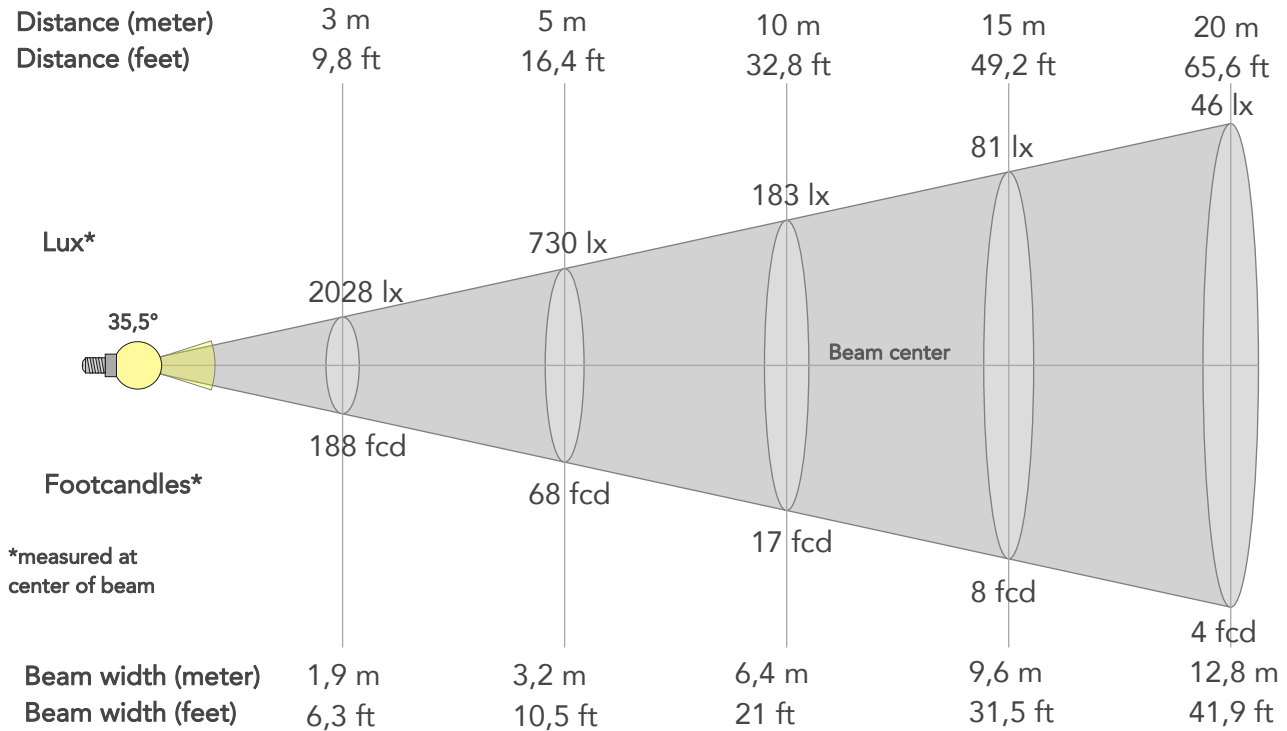

BEAM INTENSITIES AND WIDTHS

Distance	1m	2m	3m	4m	5m	7,5m	10m	15m	20m	25m	30m	40m	50m
Distance	3,3ft	6,6ft	9,8ft	13,1ft	16,4ft	24,6ft	32,8ft	49,2ft	65,6ft	82ft	98,4ft	131,2ft	164ft
Lux	18253lx	4563lx	2028lx	1141lx	730lx	324lx	183lx	81lx	46lx	29lx	20lx	11lx	7lx
Footcand.	1696fcd	424fcd	188fcd	106fcd	68fcd	30fcd	17fcd	8fcd	4fcd	3fcd	2fcd	1fcd	1fcd
Beam wid.	0,6m	1,3m	1,9m	2,6m	3,2m	4,8m	6,4m	9,6m	12,8m	16m	19,2m	25,6m	32m
Beam wid.	2,1ft	4,2ft	6,3ft	8,4ft	10,5ft	15,7ft	21ft	31,5ft	41,9ft	52,4ft	62,9ft	83,9ft	104,8ft

LINEAR DISTRIBUTION DIAGRAM

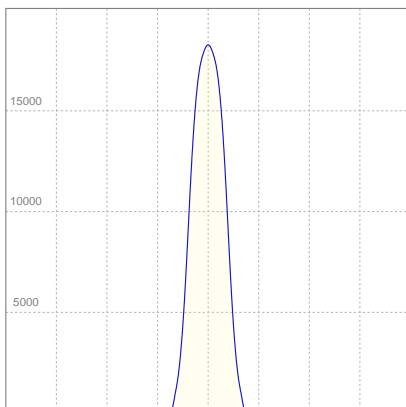

ELECTRICAL SPECIFICATIONS

Input voltage	Input current	Input power	Effeciency
226V	1,67A	351,6W	18lm/W

ISO CANDELA DIAGRAM

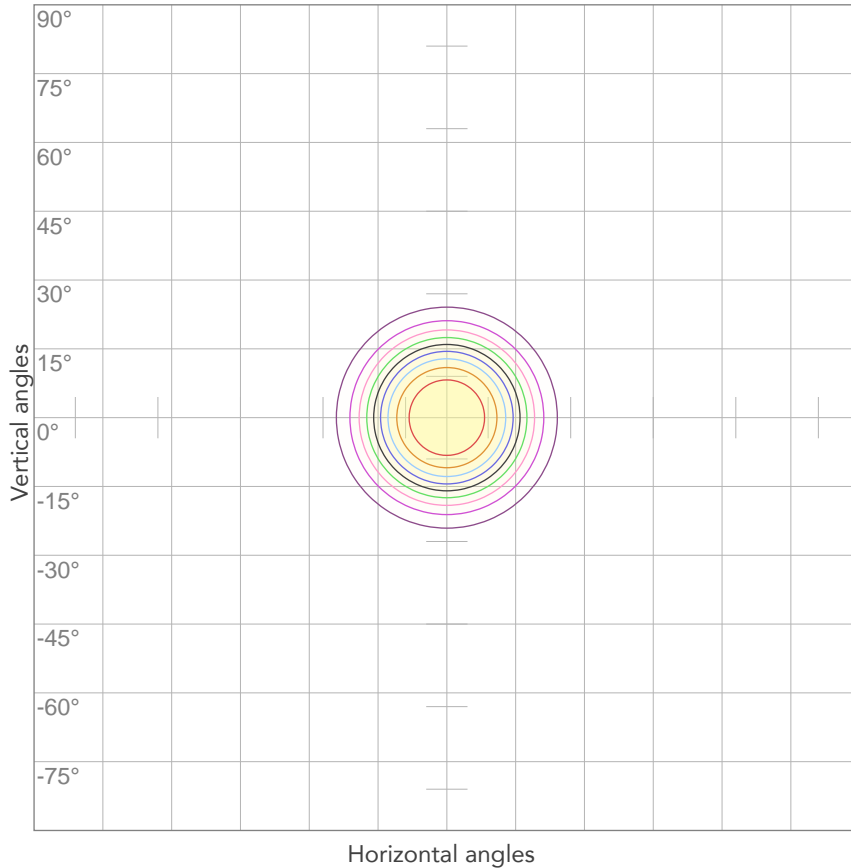

10%	1825 cd
20%	3651 cd
30%	5476 cd
40%	7301 cd
50%	9126 cd
60%	10952 cd
70%	12777 cd
80%	14602 cd

Conditions:

Number of c-planes: 2

Candela at center: 18253 cd

ISO LUX DIAGRAM

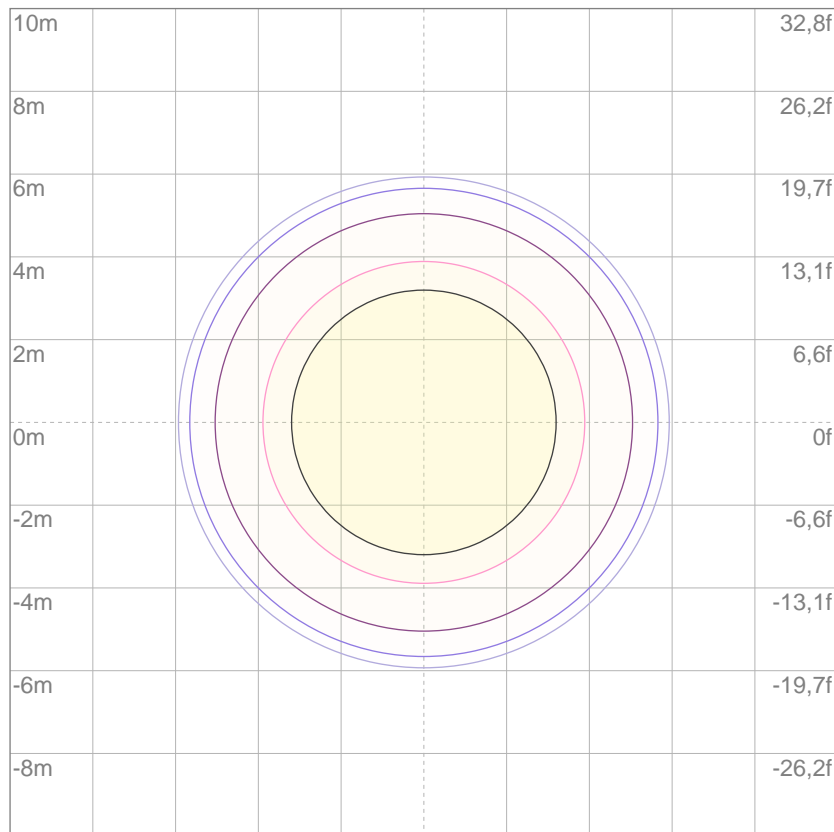

3%	5,48 lx
5%	9,13 lx
10%	18,3 lx
30%	54,8 lx
50%	91,3 lx

Conditions:

Number of c-planes: 2

Lux at center: 183 lx

Lux distribution on a surface when lamp is mounted at 10 meters from the surface.

Mounting height: 10 meters (33 feet)



Total lumen output:

5297 lm

Peak candela output:

65904 cd

Light quality:

CRI: 41,2

Color temperature:

2865 K

PRODUCT NAME:

ASTRAWASH19PIX

MEASURAMENT CONDITIONS:

Beam angle:

Med Zoom

Target:

2800K

Operator:

Paolo Carvone

Date and time:

15/02/2021 12:03:23

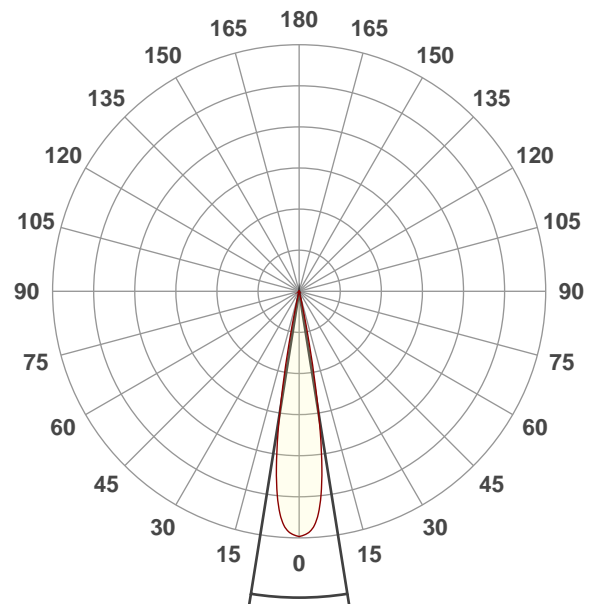

Spectra

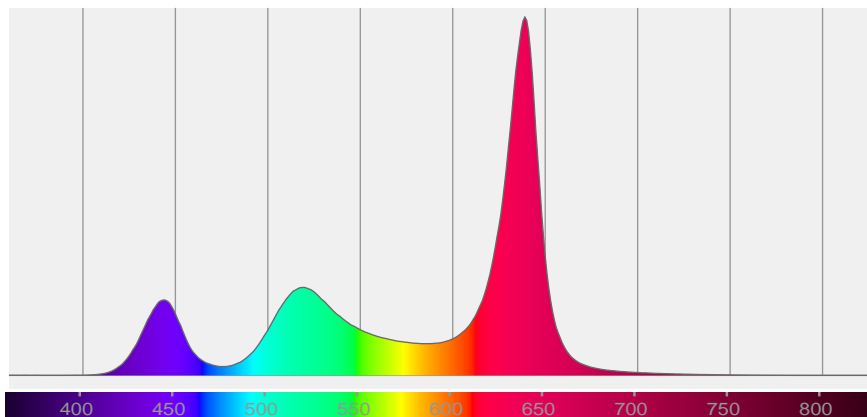

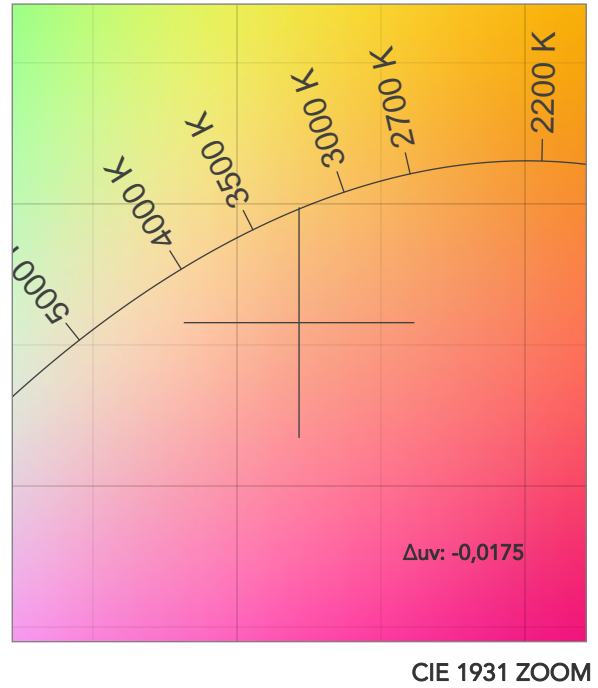
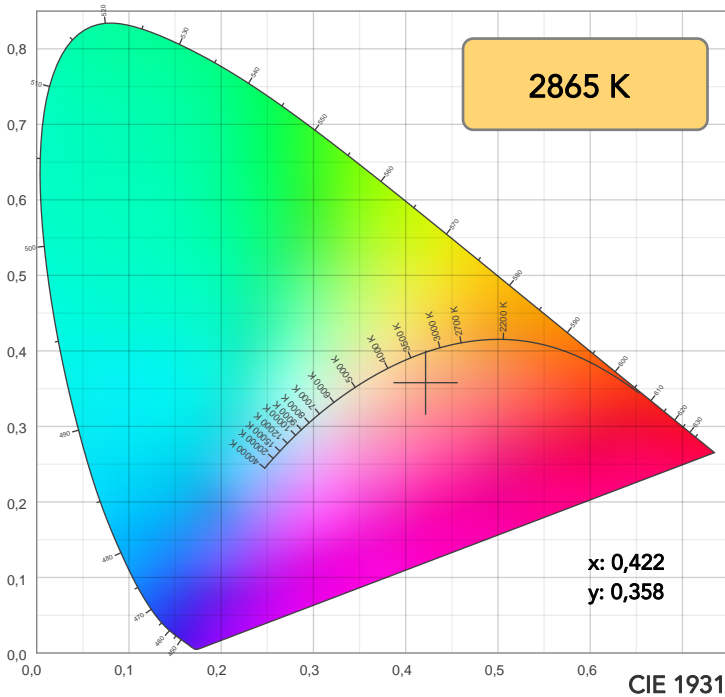

TM30: 59,2

CRI: 41,2 (R1-R8)

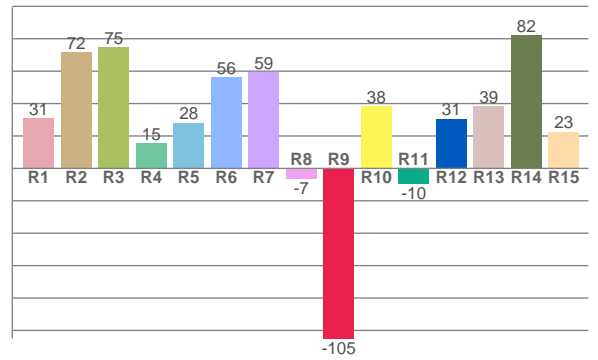
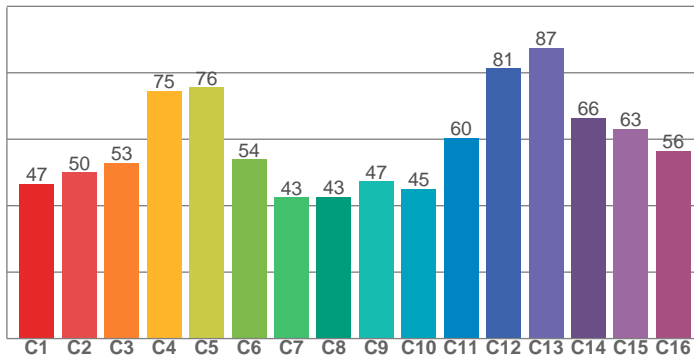

CRI R values, only R1-R8 are used to calculate final CRI value

R1	R2	R3	R4	R5	R6	R7	R8	R9	R10	R11	R12	R13	R14	R15
30,9	71,6	74,6	15,4	28,2	56,1	59,2	-6,6	-105,0	38,4	-9,7	30,7	38,5	82,0	22,7

TM30 C values, 16 binned values out of total of 99 C values

C1	C2	C3	C4	C5	C6	C7	C8	C9	C10	C11	C12	C13	C14	C15	C16
46,6	50,0	52,8	74,5	75,6	54,0	42,5	42,6	47,3	45,1	60,3	81,3	87,5	66,4	63,1	56,5

CQS Q values

Q1	Q2	Q3	Q4	Q5	Q6	Q7	Q8	Q9	Q10	Q11	Q12	Q13	Q14	Q15
79,5	92,9	81,8	50,7	45,1	50,8	87,1	77,7	85,1	88,9	67,4	60,5	63,3	79,6	82,3

CQS: 68,8

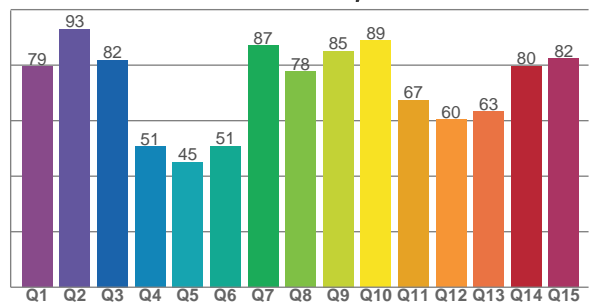

COLOR PARAMETERS

Color temperature	Color rendering index	Red component	Color fidelity	Color gamut	Color quality scale	Television lighting index	Color coordinate cie 1931	Color coordinate cie 1931	Color deviation from black body
CCT	CRI	CRI R9	TM30 Rf	TM30 Rg	CQS	TLCI	x	y	Δuv
2865 K	41,2	-105,0	59,2	130,2	68,8	25	0,422	0,358	-0,0175

TM30 DETAILS

Rf 59,2
Fidelity index Rf

Rg 130,2
Gammut index

Hue Bin	R _f	Graphic shifts (%)	
		Chroma	Hue
1	47	24%	-5%
2	50	20%	-14%
3	53	13%	-16%
4	75	10%	-5%
5	76	14%	8%
6	54	24%	15%
7	43	33%	4%
8	43	30%	-14%
9	47	21%	-22%
10	45	8%	-31%
11	60	0%	-27%
12	81	-1%	-9%
13	87	4%	5%
14	66	3%	23%
15	63	17%	12%
16	56	26%	11%

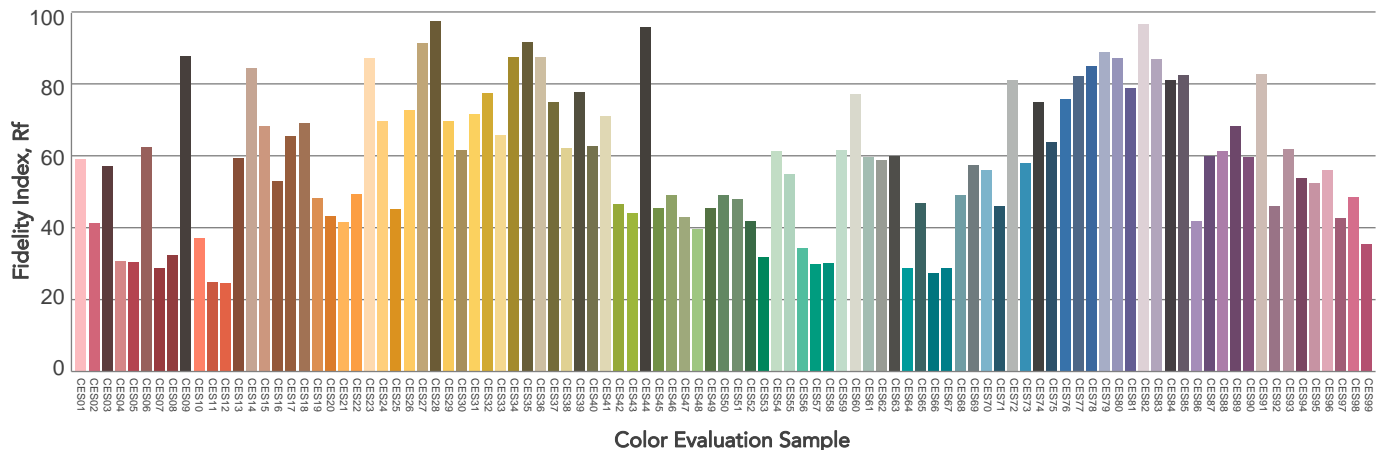
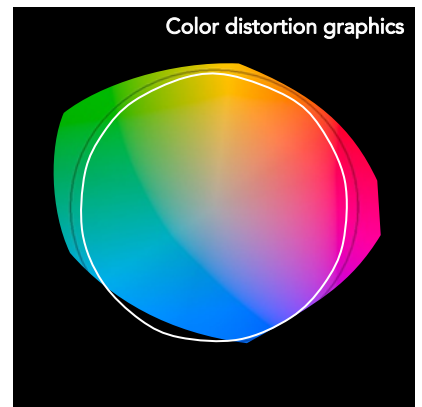
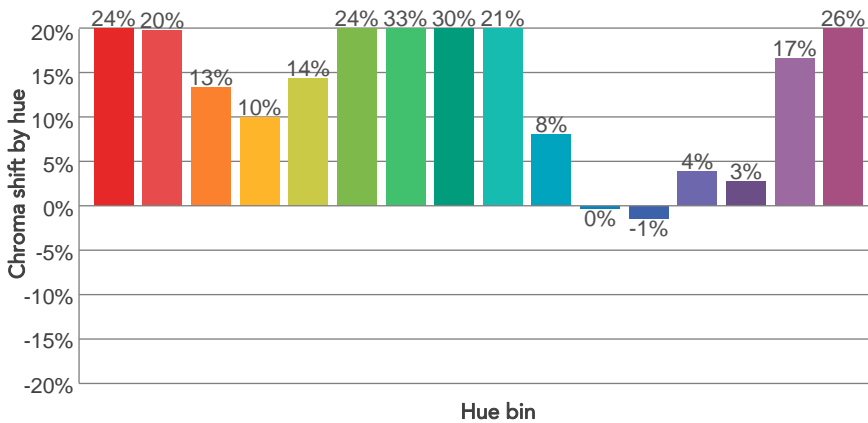
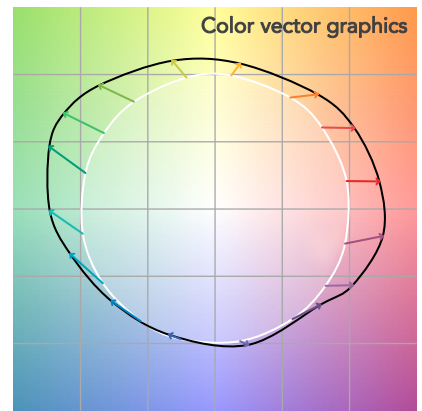
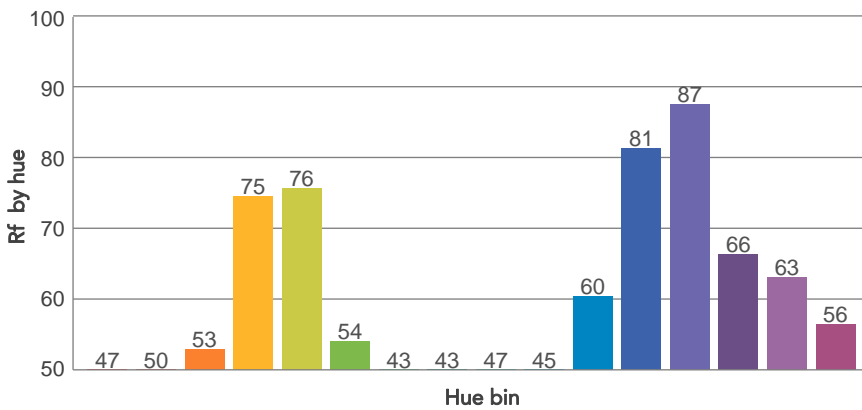
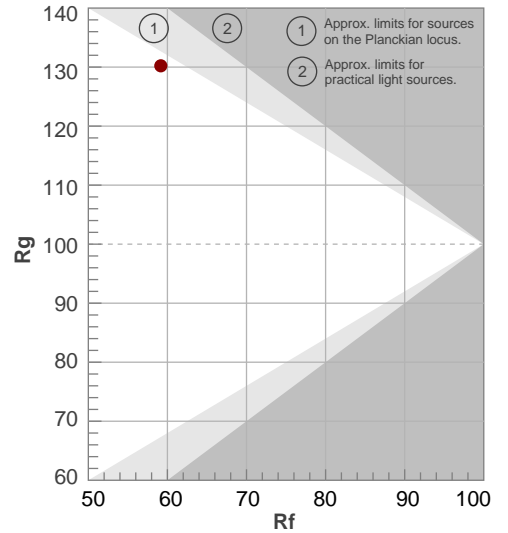

BEAM DETAILS



Beam angle 50%	Field angle 10%	Cut off angle 2,5%	Intensity ratio in 120° cone	Intensity ratio in 90° cone
18,1°	24°	26,4°	100,0%	100,0%

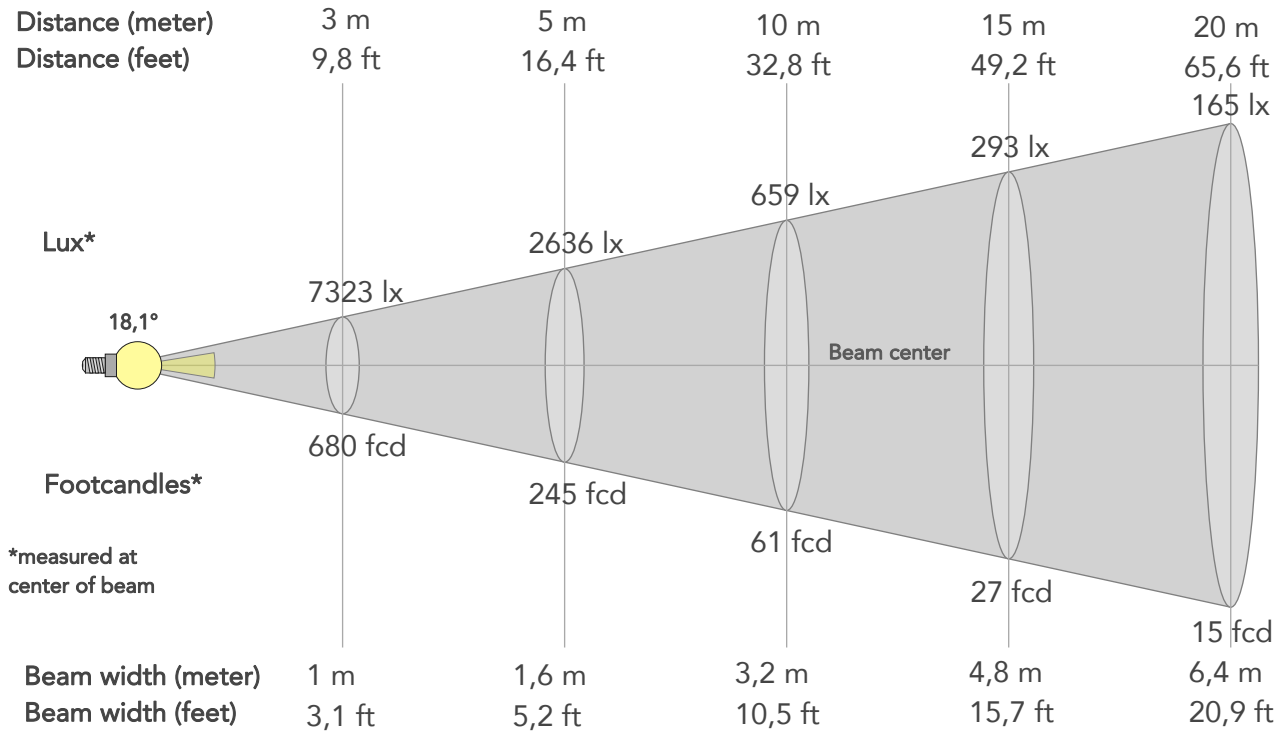

BEAM INTENSITIES AND WIDTHS

Distance	1m	2m	3m	4m	5m	7,5m	10m	15m	20m	25m	30m	40m	50m
Distance	3,3ft	6,6ft	9,8ft	13,1ft	16,4ft	24,6ft	32,8ft	49,2ft	65,6ft	82ft	98,4ft	131,2ft	164ft
Lux	65904lx	16476lx	7323lx	4119lx	2636lx	1172lx	659lx	293lx	165lx	105lx	73lx	41lx	26lx
Footcand.	6123fcd	1531fcd	680fcd	383fcd	245fcd	109fcd	61fcd	27fcd	15fcd	10fcd	7fcd	4fcd	2fcd
Beam wid.	0,3m	0,6m	1m	1,3m	1,6m	2,4m	3,2m	4,8m	6,4m	8m	9,6m	12,8m	15,9m
Beam wid.	1,1ft	2,1ft	3,1ft	4,2ft	5,2ft	7,8ft	10,5ft	15,7ft	20,9ft	26,1ft	31,4ft	41,8ft	52,3ft

LINEAR DISTRIBUTION DIAGRAM

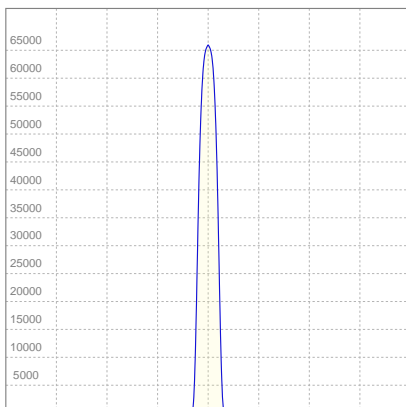

ELECTRICAL SPECIFICATIONS

Input voltage	Input current	Input power	Effeciency
224V	1,67A	351,1W	15lm/W

ISO CANDELA DIAGRAM

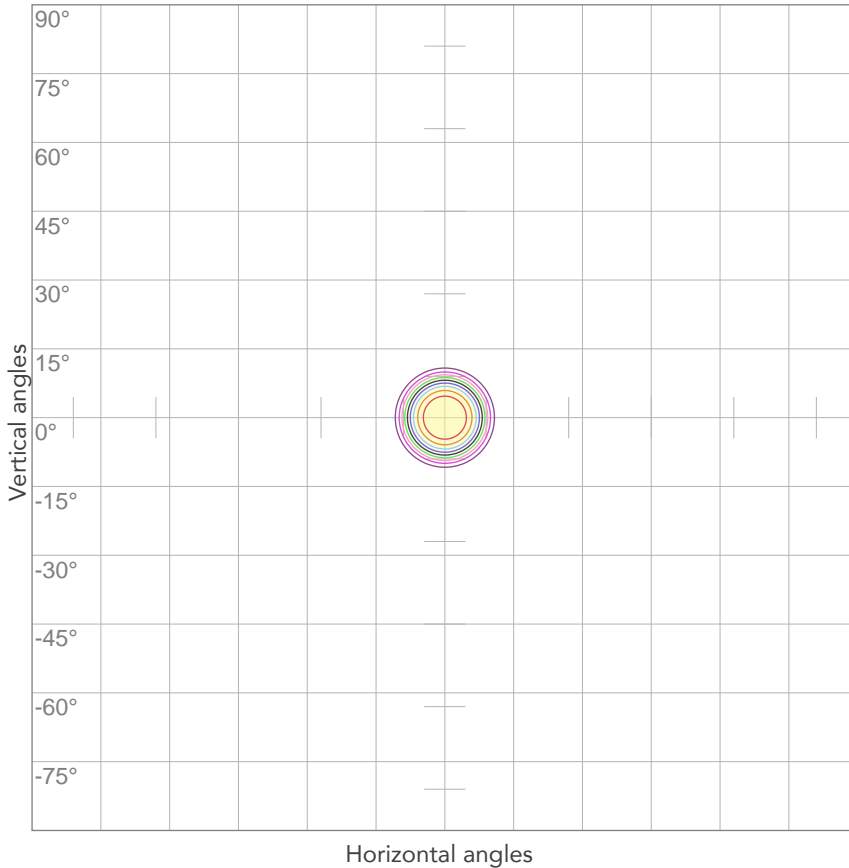

10%	6590 cd
20%	13181 cd
30%	19771 cd
40%	26362 cd
50%	32952 cd
60%	39543 cd
70%	46133 cd
80%	52724 cd

Conditions:

Number of c-planes: 2

Candela at center: 65904 cd

ISO LUX DIAGRAM

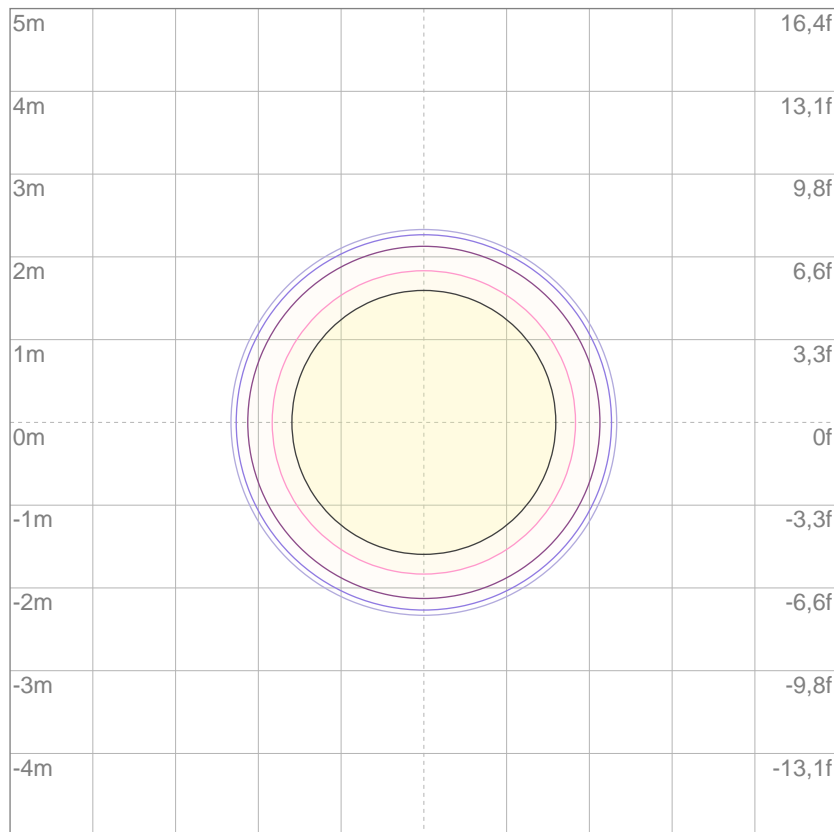

3%	19,8 lx
5%	33,0 lx
10%	65,9 lx
30%	198 lx
50%	330 lx

Conditions:

Number of c-planes: 2

Lux at center: 659 lx

Lux distribution on a surface when lamp is mounted at 10 meters from the surface.

Mounting height: 10 meters (33 feet)



Total lumen output:

3433 lm

Peak candela output:

709248 cd

Light quality:

CRI: 39,7

Color temperature:

2813 K

PRODUCT NAME:

ASTRAWASH19PIX

MEASUREMENT CONDITIONS:

Beam angle:

Min Zoom

Target:

2800K

Operator:

Paolo Carvone

Date and time:

15/02/2021 11:41:59

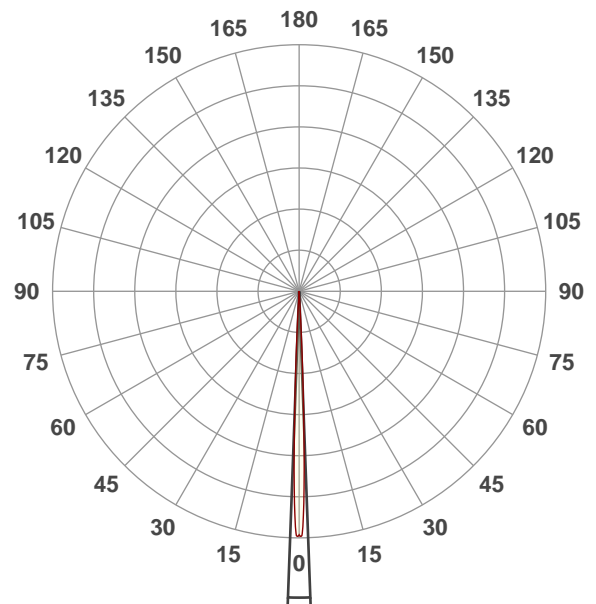

Spectra

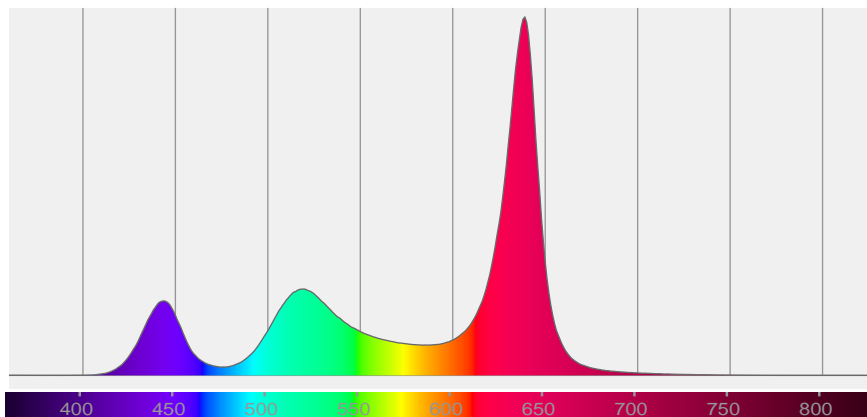

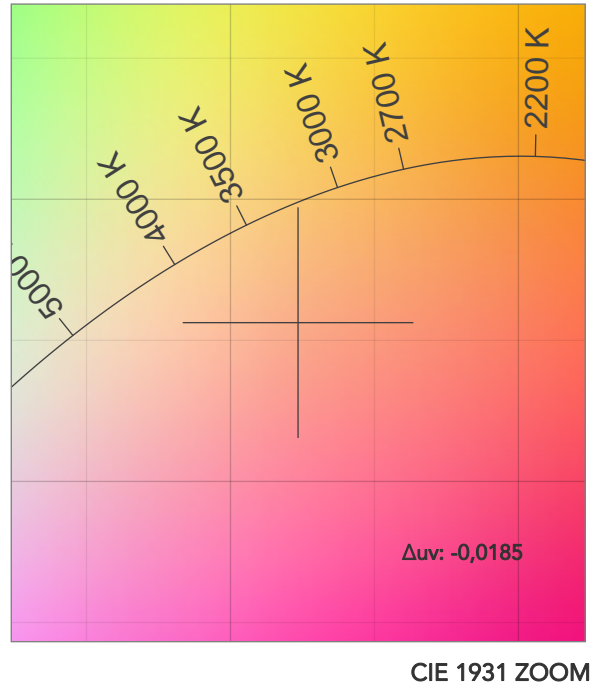
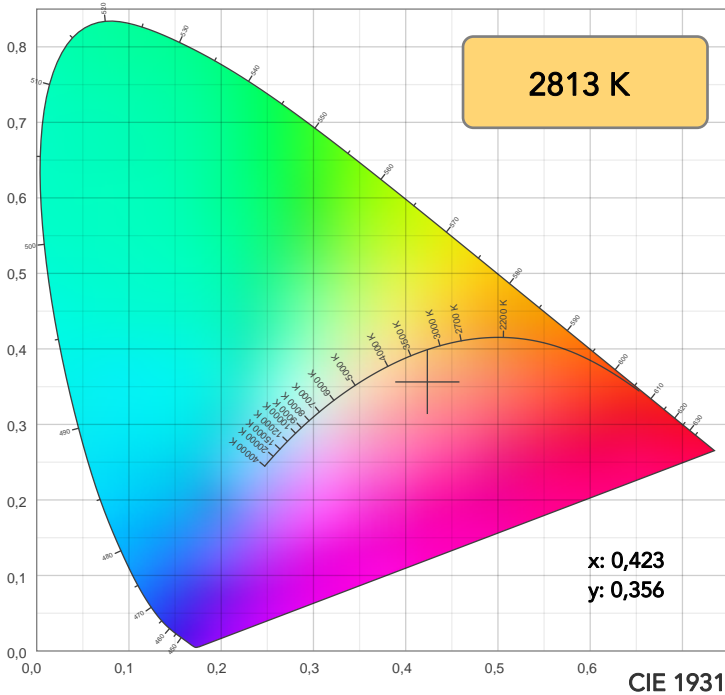

TM30: 58,0

CRI: 39,7 (R1-R8)

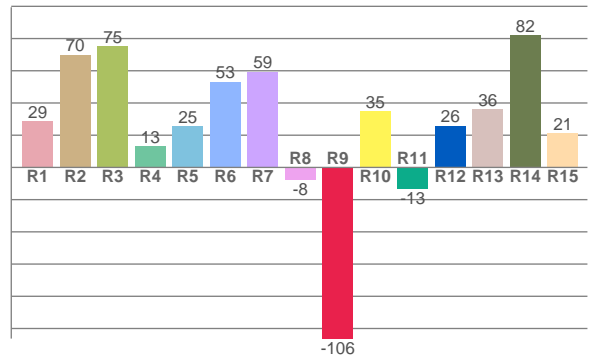
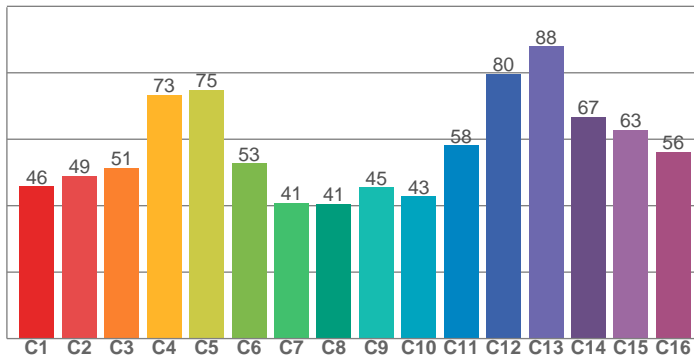

CRI R values, only R1-R8 are used to calculate final CRI value

R1	R2	R3	R4	R5	R6	R7	R8	R9	R10	R11	R12	R13	R14	R15
28,8	70,0	75,3	13,0	25,5	53,1	59,3	-7,7	-106,3	34,8	-13,4	25,8	36,2	82,3	21,2

TM30 C values, 16 binned values out of total of 99 C values

C1	C2	C3	C4	C5	C6	C7	C8	C9	C10	C11	C12	C13	C14	C15	C16
45,7	49,0	51,4	73,3	74,8	52,7	40,9	40,5	45,5	42,8	58,1	79,7	87,9	66,7	62,8	56,2

CQS Q values

Q1	Q2	Q3	Q4	Q5	Q6	Q7	Q8	Q9	Q10	Q11	Q12	Q13	Q14	Q15
79,7	93,1	80,7	48,8	43,3	49,1	86,1	77,8	85,4	88,4	66,7	60,0	63,1	79,0	82,0

CQS: 67,9

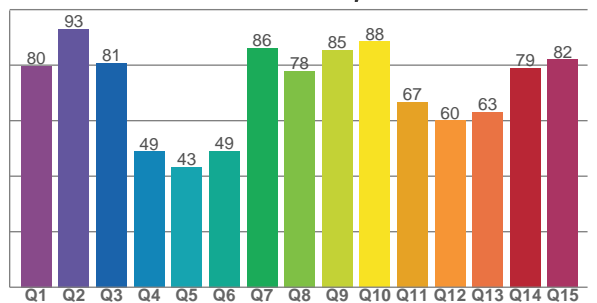

COLOR PARAMETERS

Color temperature	Color rendering index	Red component	Color fidelity	Color gamut	Color quality scale	Television lighting index	Color coordinate cie 1931	Color coordinate cie 1931	Color deviation from black body
CCT	CRI	CRI R9	TM30 Rf	TM30 Rg	CQS	TLCI	x	y	Δuv
2813 K	39,7	-106,3	58,0	131,1	67,9	24	0,423	0,356	-0,0185

TM30 DETAILS

Rf 58,0
Fidelity index Rf

Rg 131,1
Gammut index

Hue Bin	R _f	Graphic shifts (%)	
		Chroma	Hue
1	46	24%	-5%
2	49	20%	-14%
3	51	14%	-16%
4	73	11%	-5%
5	75	15%	8%
6	53	25%	15%
7	41	34%	4%
8	41	31%	-14%
9	45	22%	-22%
10	43	9%	-33%
11	58	0%	-28%
12	80	-1%	-10%
13	88	4%	5%
14	67	2%	23%
15	63	17%	12%
16	56	26%	11%

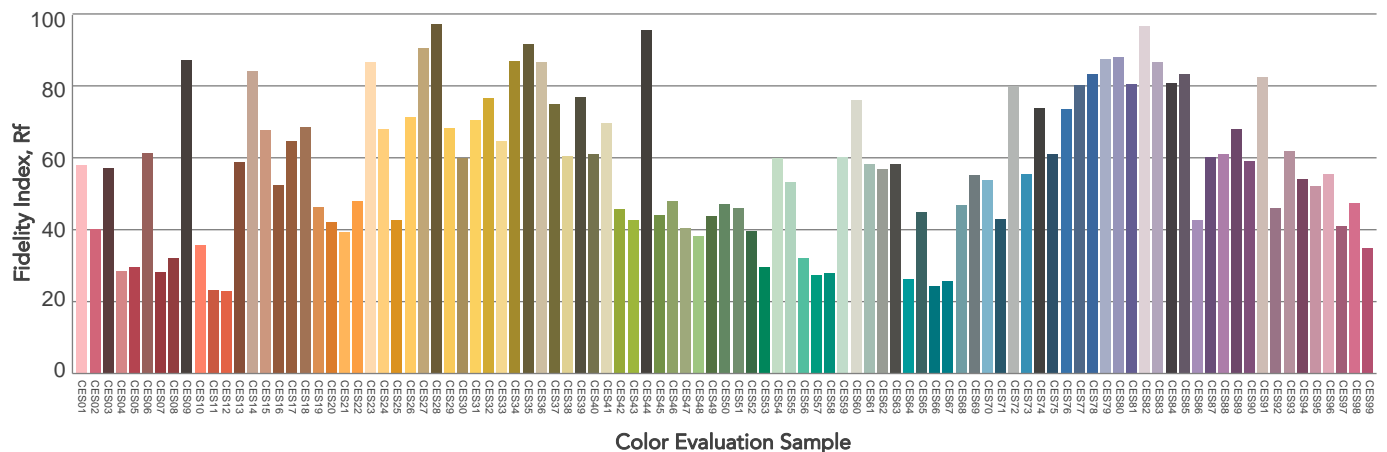
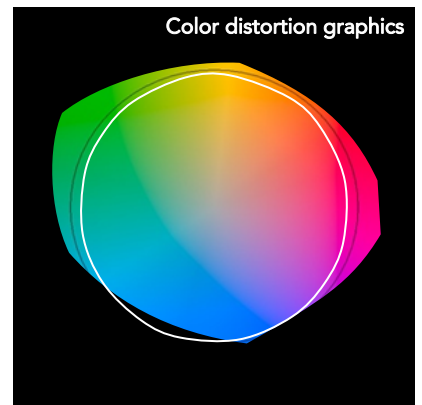
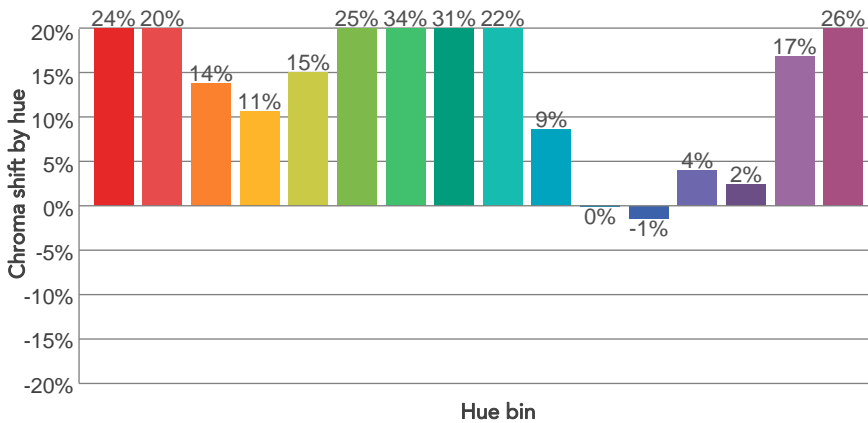
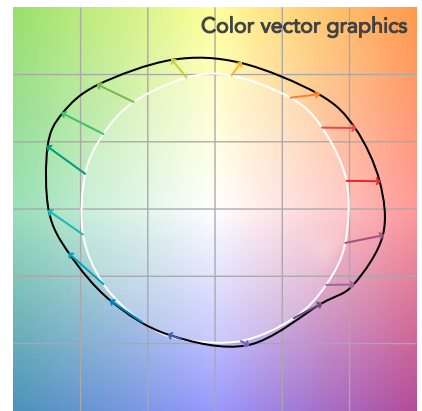
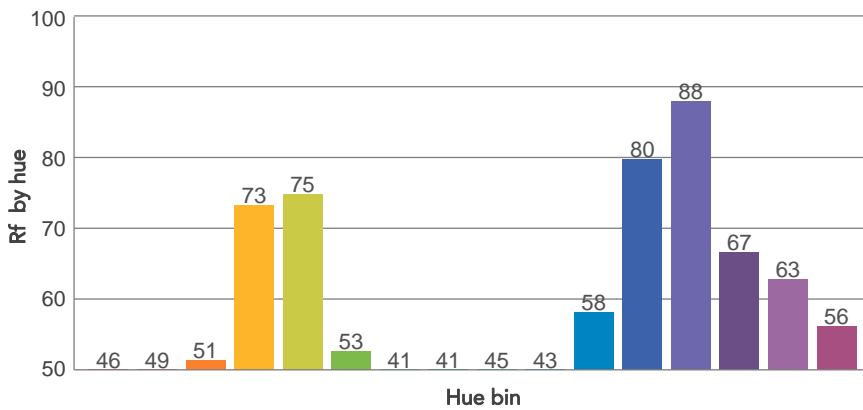
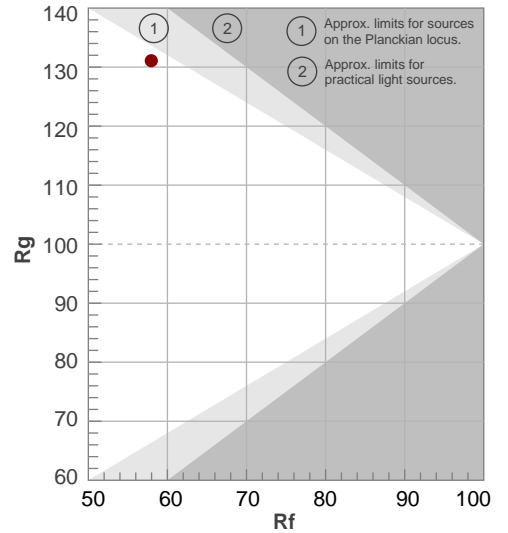

BEAM DETAILS



Beam angle 50%	Field angle 10%	Cut off angle 2,5%	Intensity ratio in 120° cone	Intensity ratio in 90° cone
4,2°	6,3°	7°	100,0%	100,0%

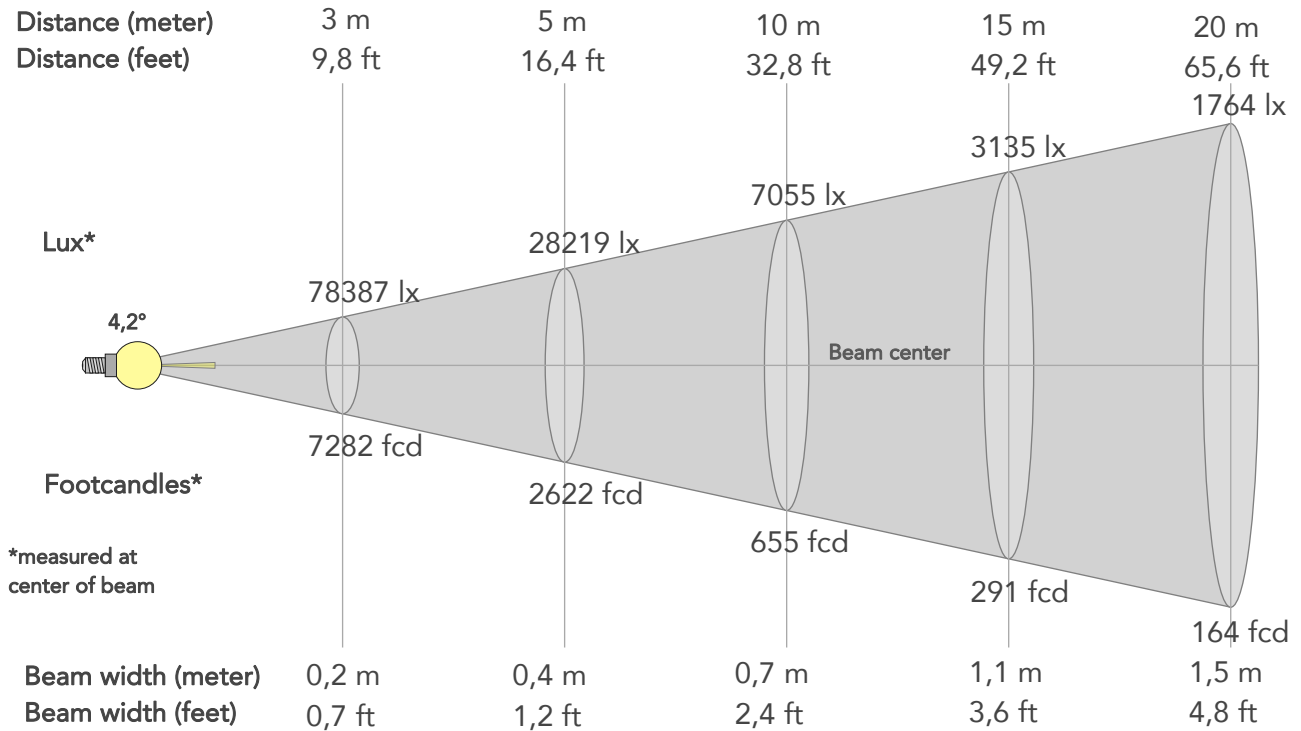

BEAM INTENSITIES AND WIDTHS

Distance	1m	2m	3m	4m	5m	7,5m	10m	15m	20m	25m	30m	40m	50m
Distance	3,3ft	6,6ft	9,8ft	13,1ft	16,4ft	24,6ft	32,8ft	49,2ft	65,6ft	82ft	98,4ft	131,2ft	164ft
Lux	705484lx	176371lx	78387lx	44093lx	28219lx	12542lx	7055lx	3135lx	1764lx	1129lx	784lx	441lx	282lx
Footcand.	65542fcd	16385fcd	7282fcd	4096fcd	2622fcd	1165fcd	655fcd	291fcd	164fcd	105fcd	73fcd	41fcd	26fcd
Beam wid.	0,1m	0,1m	0,2m	0,3m	0,4m	0,5m	0,7m	1,1m	1,5m	1,8m	2,2m	2,9m	3,7m
Beam wid.	0,2ft	0,5ft	0,7ft	1ft	1,2ft	1,8ft	2,4ft	3,6ft	4,8ft	6ft	7,2ft	9,6ft	12ft

LINEAR DISTRIBUTION DIAGRAM

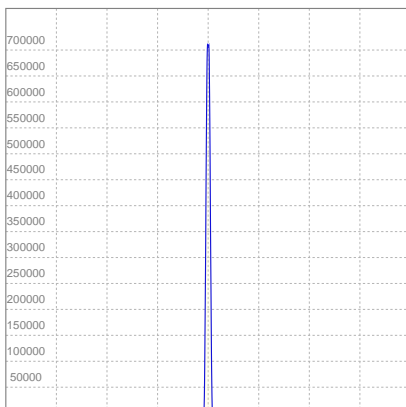

ELECTRICAL SPECIFICATIONS

Input voltage	Input current	Input power	Effeciency
223V	1,69A	352,2W	10lm/W

ISO CANDELA DIAGRAM

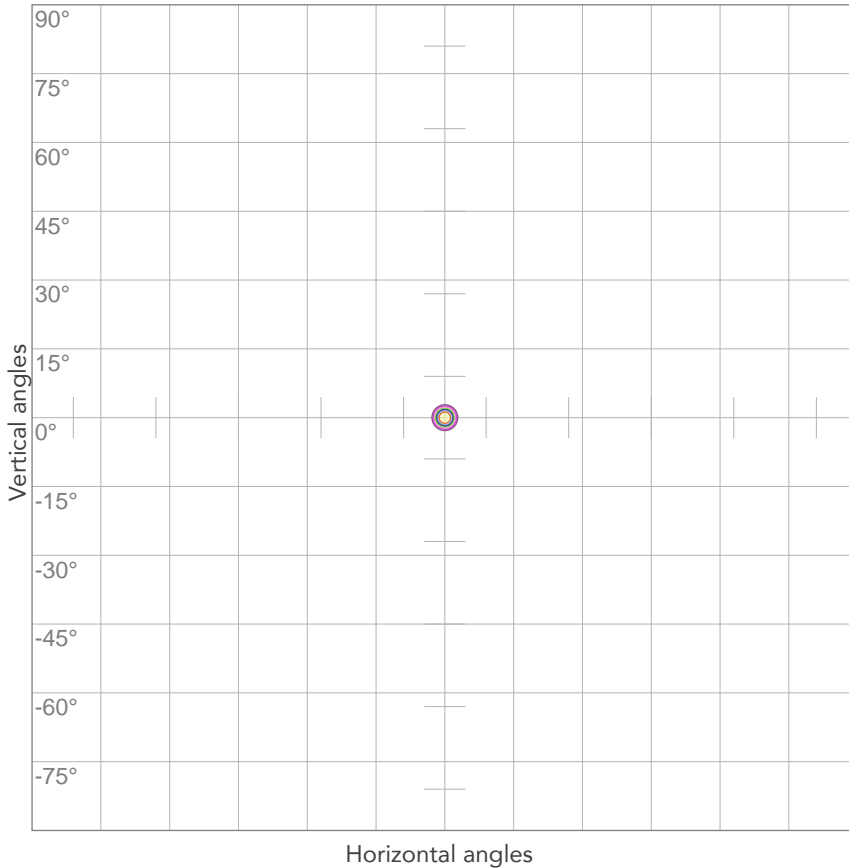

10%	70548 cd
20%	141097 cd
30%	211645 cd
40%	282194 cd
50%	352742 cd
60%	423291 cd
70%	493839 cd
80%	564387 cd

Conditions:

Number of c-planes: 2

Candela at center: 705484 cd

ISO LUX DIAGRAM

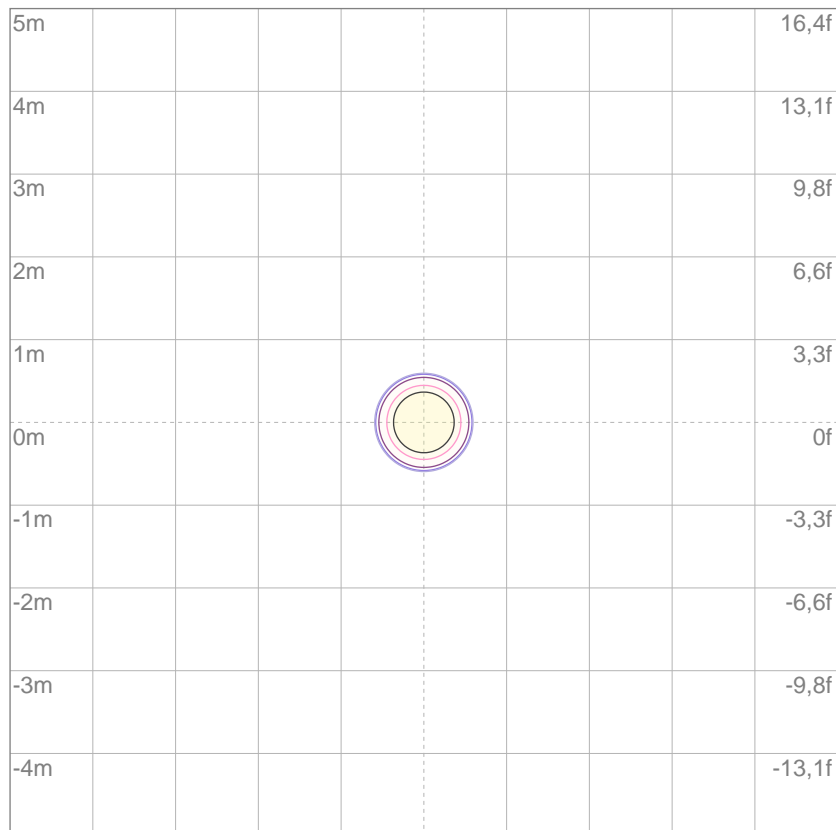

3%	212 lx
5%	353 lx
10%	705 lx
30%	2116 lx
50%	3527 lx

Conditions:

Number of c-planes: 2

Lux at center: 7055 lx

Lux distribution on a surface when lamp is mounted at 10 meters from the surface.

Mounting height: 10 meters (33 feet)



Total lumen output:

7355 lm

Peak candela output:

21379 cd

Light quality:

CRI: 51,5

Color temperature:

3295 K

PRODUCT NAME:

ASTRAWASH19PIX

MEASURAMENT CONDITIONS:

Beam angle:

Max Zoom

Target:

3200K

Operator:

Paolo Carvone

Date and time:

15/02/2021 12:09:20

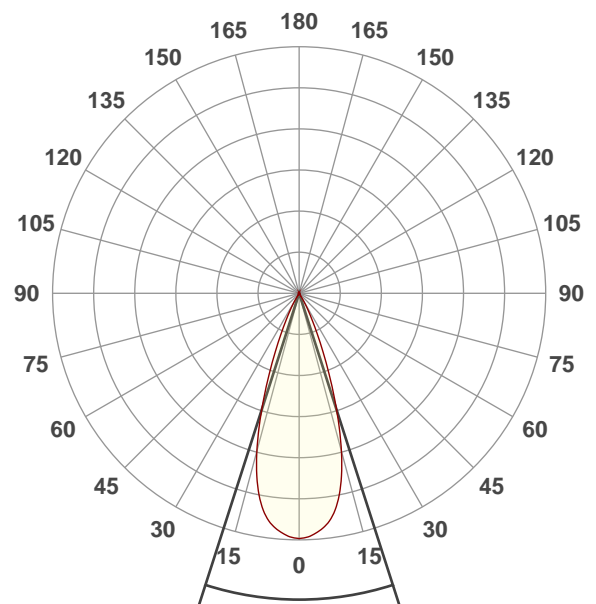

Beam angle 50%: 35,6°

Field angle 10%: 53,8°

Cut off angle 2.5%: 62,1°

Spectra

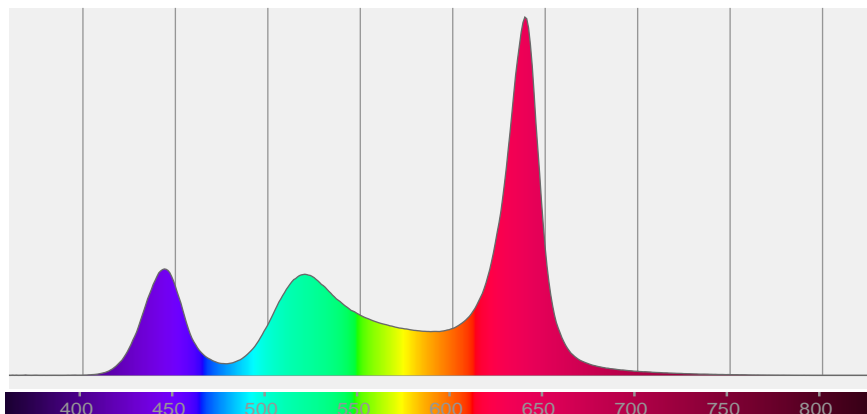

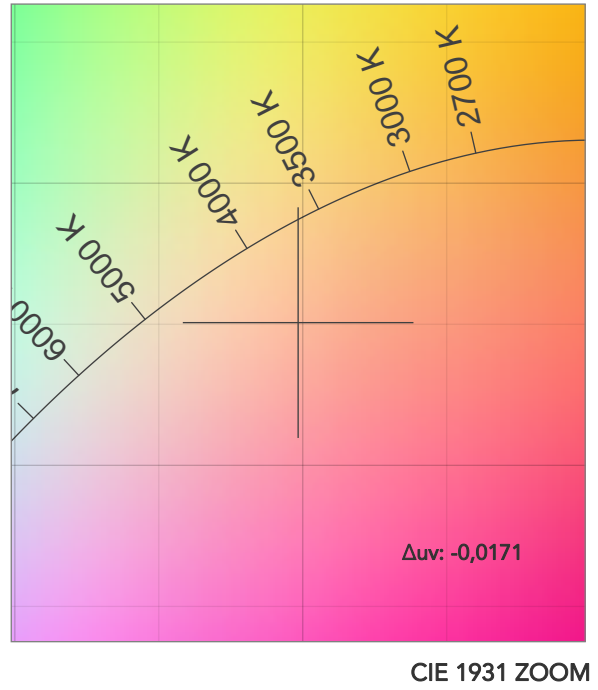
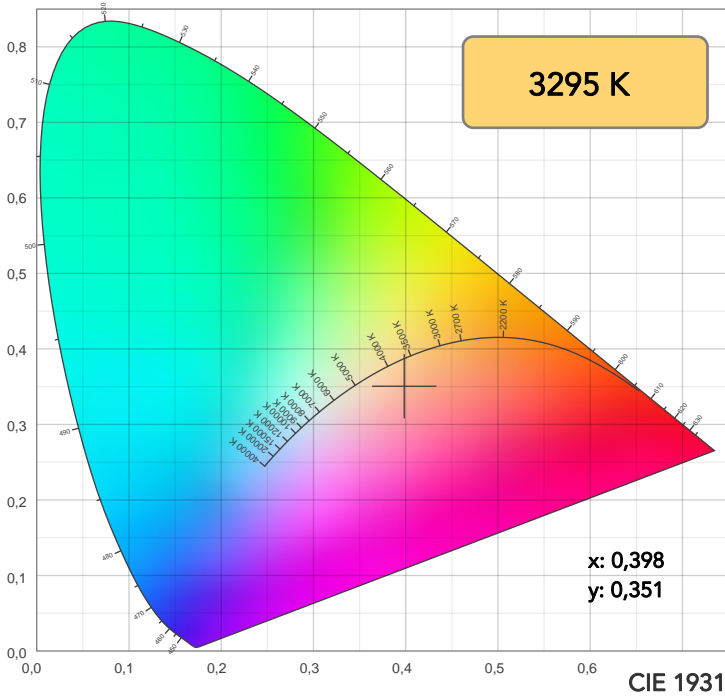

TM30: 66,0

CRI: 51,5 (R1-R8)

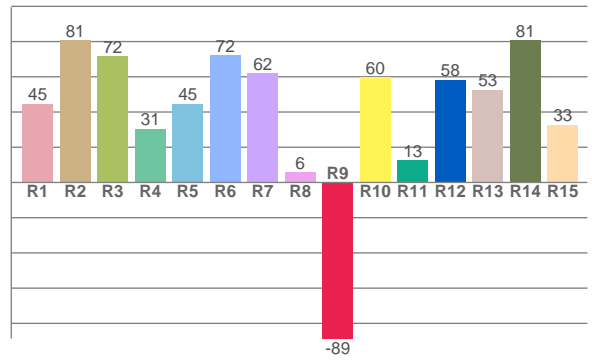
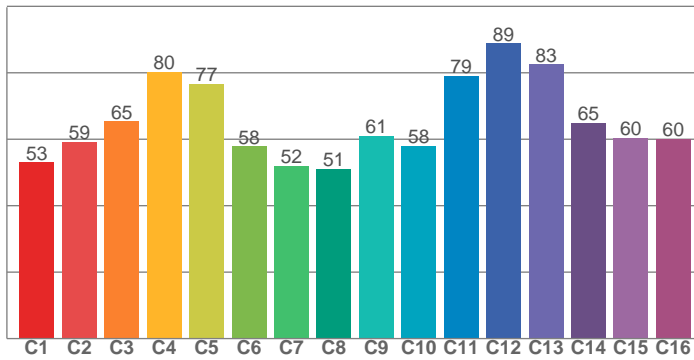

CRI R values, only R1-R8 are used to calculate final CRI value

R1	R2	R3	R4	R5	R6	R7	R8	R9	R10	R11	R12	R13	R14	R15
44,6	80,6	71,6	30,6	44,8	72,1	62,0	5,7	-88,6	59,8	12,7	58,3	52,6	80,7	32,7

TM30 C values, 16 binned values out of total of 99 C values

C1	C2	C3	C4	C5	C6	C7	C8	C9	C10	C11	C12	C13	C14	C15	C16
53,1	59,2	65,4	80,3	76,7	57,8	52,0	51,1	61,0	58,1	79,0	88,8	82,6	65,0	60,5	60,0

CQS Q values

Q1	Q2	Q3	Q4	Q5	Q6	Q7	Q8	Q9	Q10	Q11	Q12	Q13	Q14	Q15
81,1	90,9	93,3	66,0	56,7	59,9	90,2	80,0	82,5	96,3	77,2	69,3	69,8	83,0	85,3

CQS: 75,6

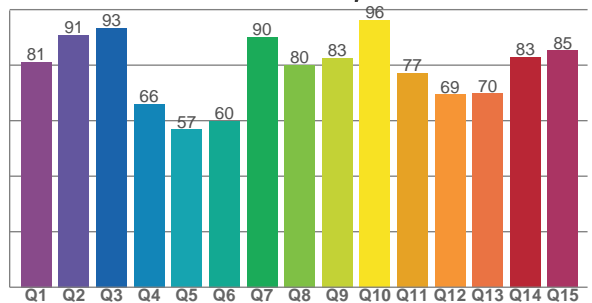

COLOR PARAMETERS

Color temperature	Color rendering index	Red component	Color fidelity	Color gamut	Color quality scale	Television lighting index	Color coordinate cie 1931	Color coordinate cie 1931	Color deviation from black body
CCT	CRI	CRI R9	TM30 Rf	TM30 Rg	CQS	TLCI	x	y	Δuv
3295 K	51,5	-88,6	66,0	127,6	75,6	36	0,398	0,351	-0,0171

TM30 DETAILS

Rf 66,0
Fidelity index Rf

Rg 127,6
Gammut index

Hue Bin	R _f	Graphic shifts (%)	
		Chroma	Hue
1	53	22%	-4%
2	59	16%	-11%
3	65	11%	-10%
4	80	7%	-1%
5	77	15%	8%
6	58	22%	13%
7	52	29%	2%
8	51	24%	-12%
9	61	16%	-18%
10	58	5%	-25%
11	79	-1%	-10%
12	89	0%	0%
13	83	5%	10%
14	65	7%	25%
15	60	17%	17%
16	60	25%	3%

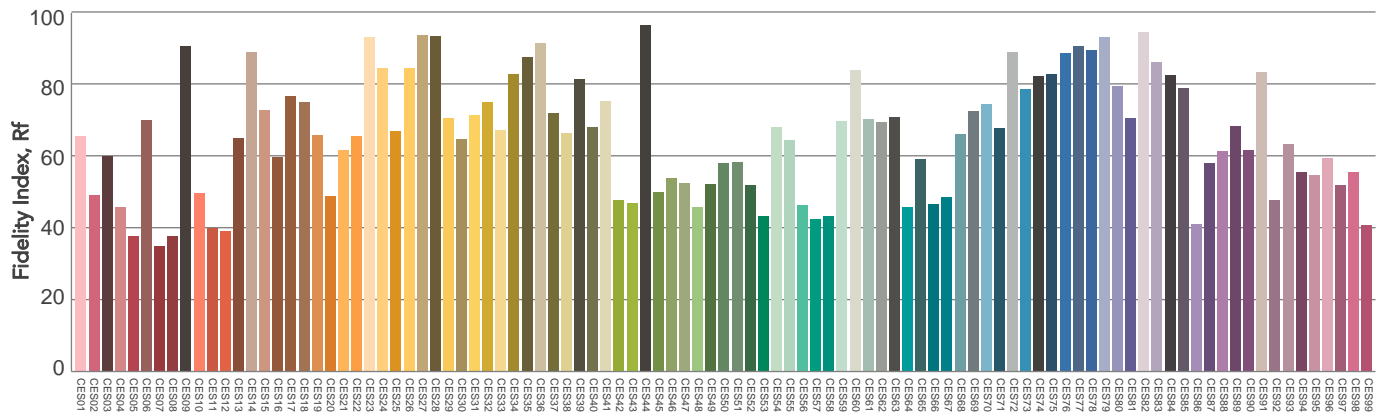
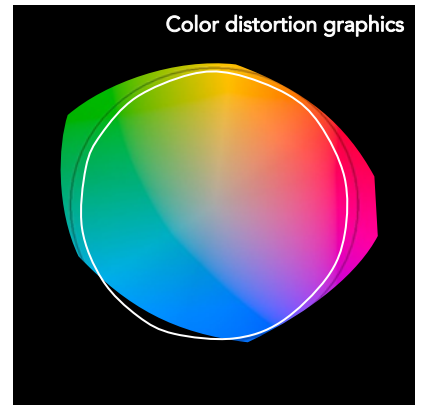
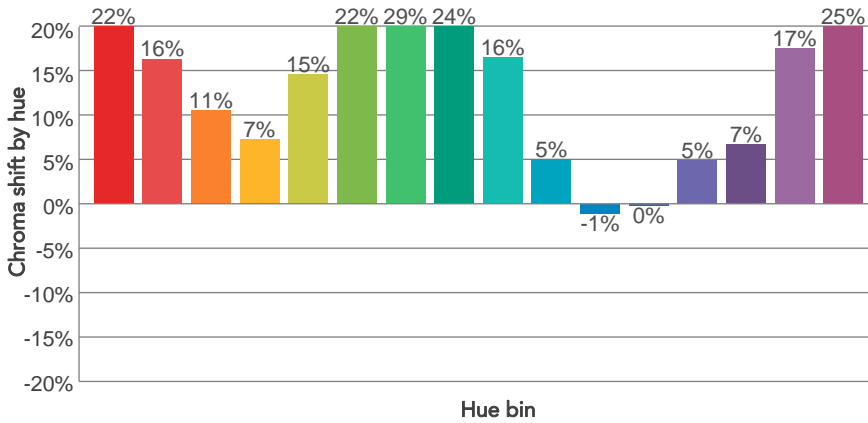
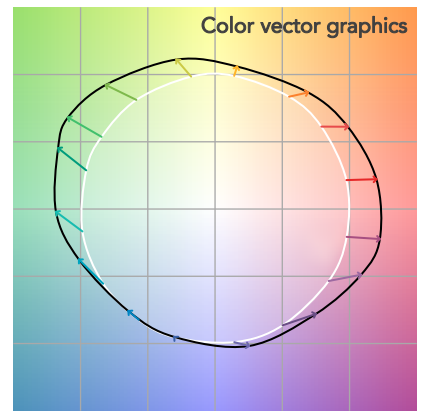
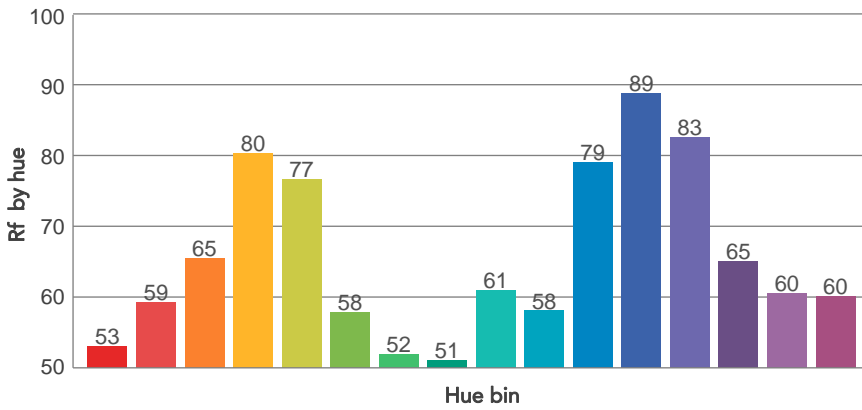
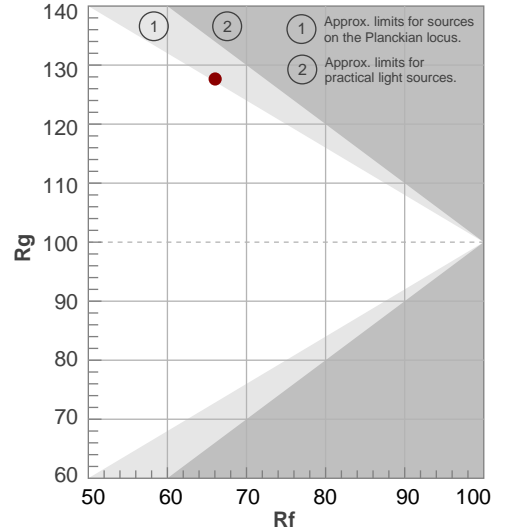

BEAM DETAILS



Beam angle 50%	Field angle 10%	Cut off angle 2,5%	Intensity ratio in 120° cone	Intensity ratio in 90° cone
35,6°	53,8°	62,1°	100,0%	100,0%

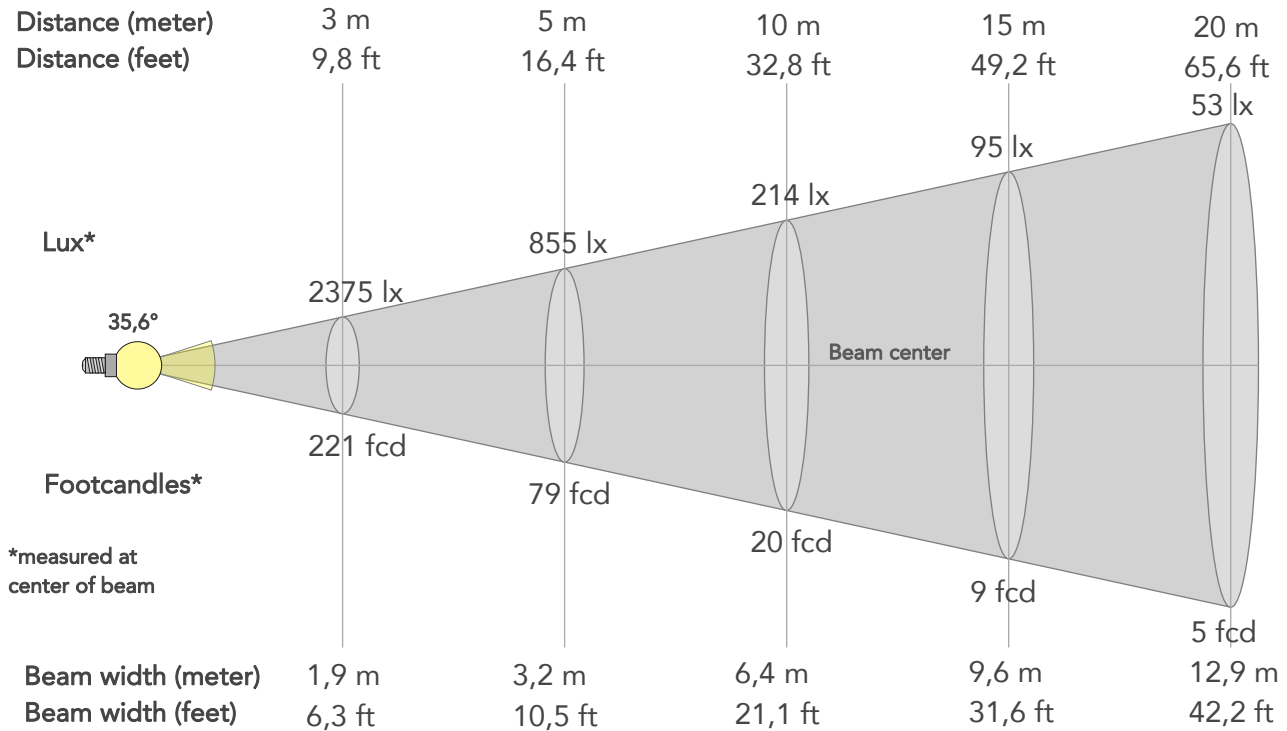

BEAM INTENSITIES AND WIDTHS

Distance	1m	2m	3m	4m	5m	7,5m	10m	15m	20m	25m	30m	40m	50m
Distance	3,3ft	6,6ft	9,8ft	13,1ft	16,4ft	24,6ft	32,8ft	49,2ft	65,6ft	82ft	98,4ft	131,2ft	164ft
Lux	21379lx	5345lx	2375lx	1336lx	855lx	380lx	214lx	95lx	53lx	34lx	24lx	13lx	9lx
Footcand.	1986fcd	497fcd	221fcd	124fcd	79fcd	35fcd	20fcd	9fcd	5fcd	3fcd	2fcd	1fcd	1fcd
Beam wid.	0,6m	1,3m	1,9m	2,6m	3,2m	4,8m	6,4m	9,6m	12,9m	16,1m	19,3m	25,7m	32,1m
Beam wid.	2,1ft	4,2ft	6,3ft	8,4ft	10,5ft	15,8ft	21,1ft	31,6ft	42,2ft	52,7ft	63,2ft	84,3ft	105,4ft

LINEAR DISTRIBUTION DIAGRAM

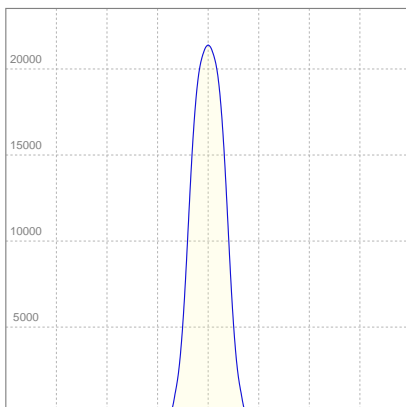

ELECTRICAL SPECIFICATIONS

Input voltage	Input current	Input power	Effeciency
224V	1,84A	386,6W	19lm/W

ISO CANDELA DIAGRAM

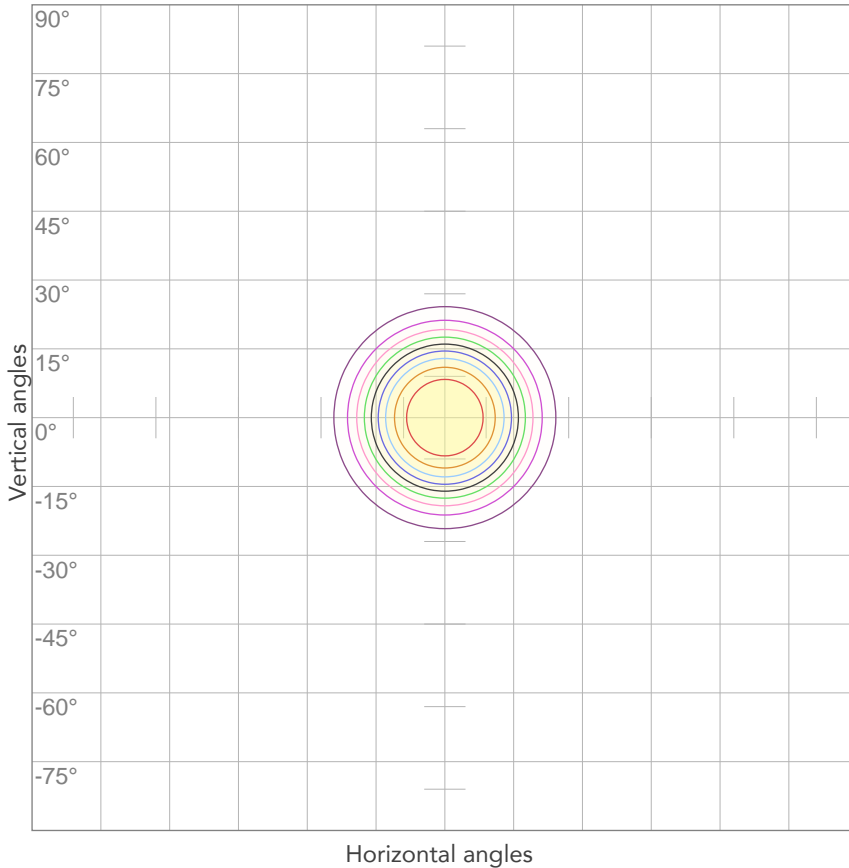

10%	2138 cd
20%	4276 cd
30%	6414 cd
40%	8552 cd
50%	10689 cd
60%	12827 cd
70%	14965 cd
80%	17103 cd

Conditions:

Number of c-planes: 2

Candela at center: 21379 cd

ISO LUX DIAGRAM

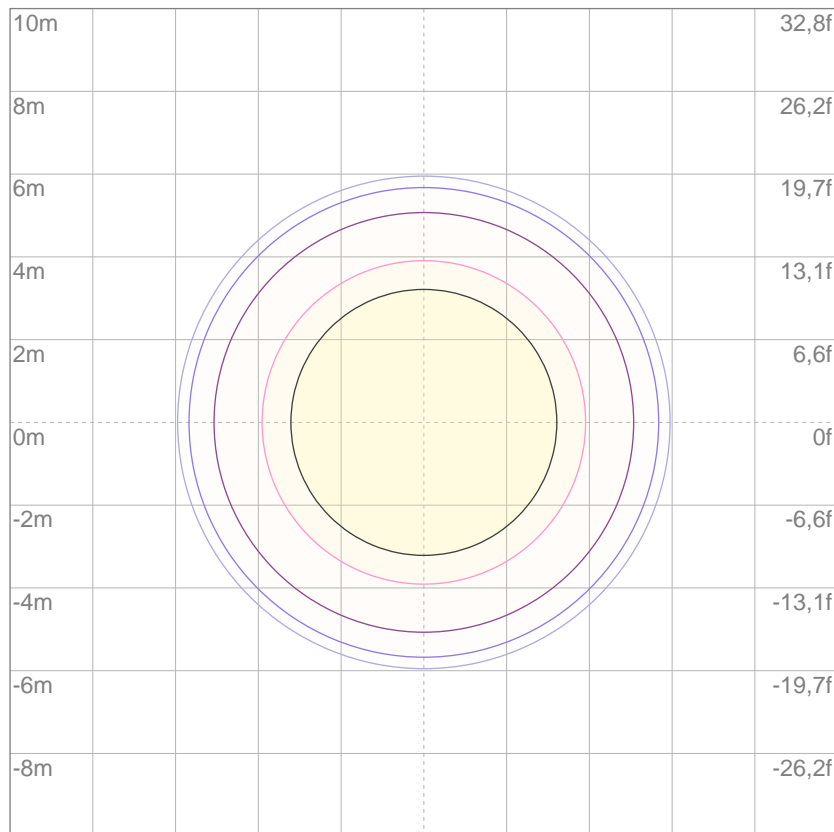

3%	6,41 lx
5%	10,7 lx
10%	21,4 lx
30%	64,1 lx
50%	107 lx

Conditions:

Number of c-planes: 2

Lux at center: 214 lx

Lux distribution on a surface when lamp is mounted at 10 meters from the surface.

Mounting height: 10 meters (33 feet)



Total lumen output:

6267 lm

Peak candela output:

77301 cd

Light quality:

CRI: 50,8

Color temperature:

3275 K

PRODUCT NAME:

ASTRAWASH19PIX

MEASURAMENT CONDITIONS:

Beam angle:

Med Zoom

Target:

3200K

Operator:

Paolo Carvone

Date and time:

15/02/2021 12:07:53

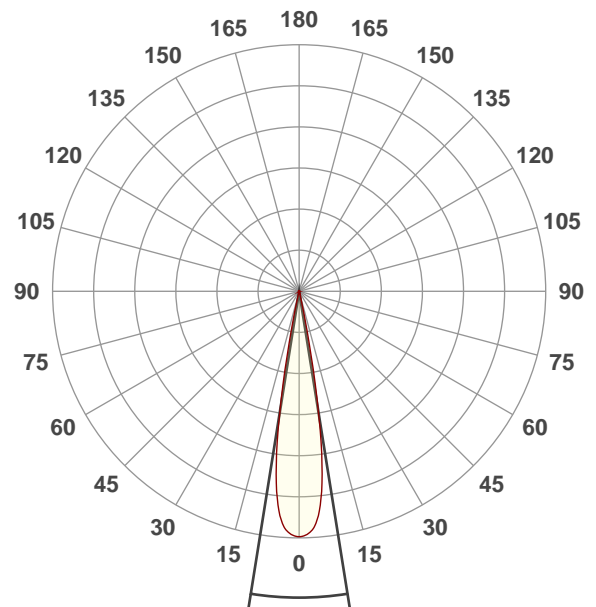

Beam angle 50%: 18,2°

Field angle 10%: 24,3°

Cut off angle 2.5%: 26,8°

Spectra

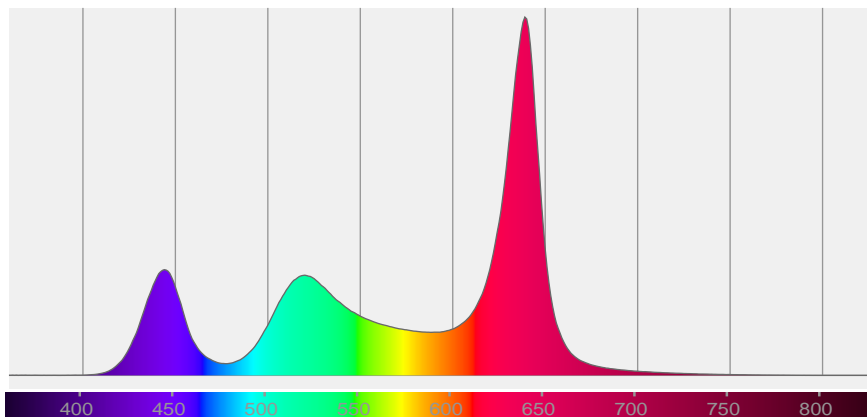

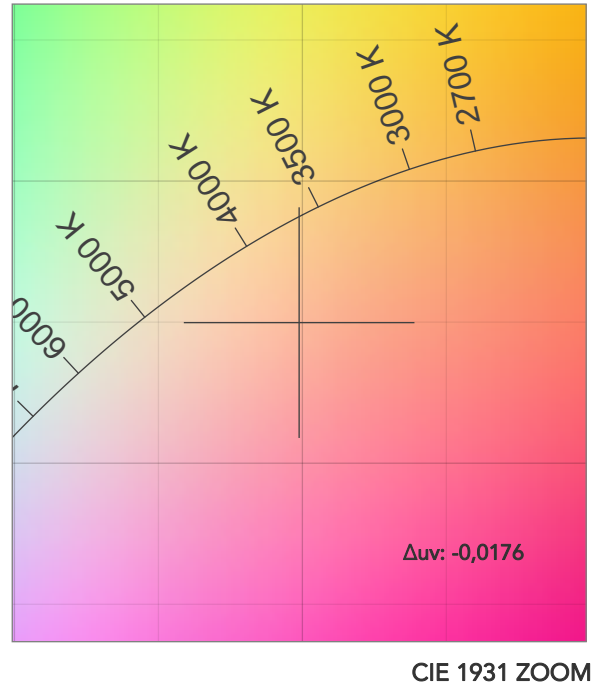
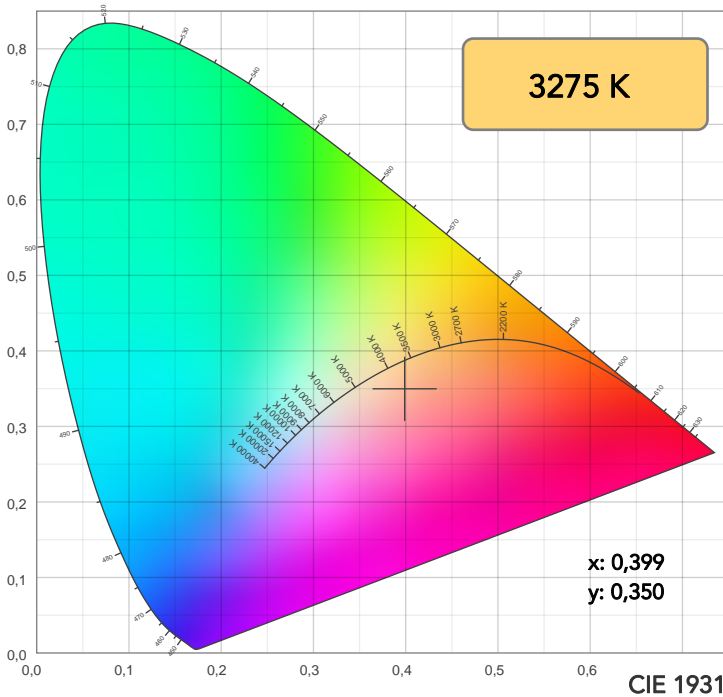

TM30: 65,7

CRI: 50,8 (R1-R8)

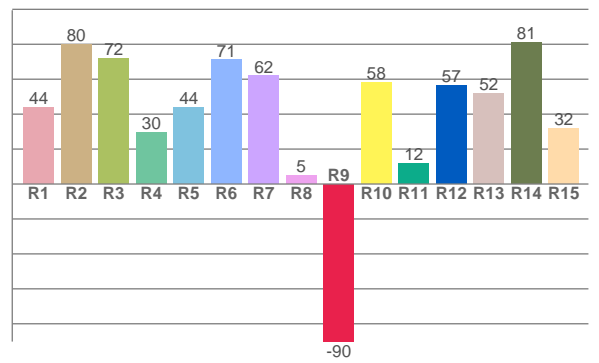
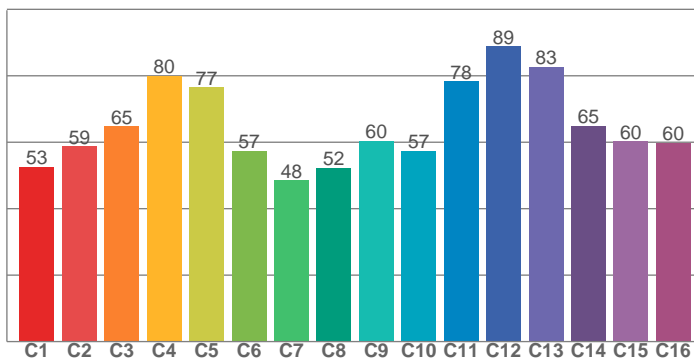

CRI R values, only R1-R8 are used to calculate final CRI value

R1	R2	R3	R4	R5	R6	R7	R8	R9	R10	R11	R12	R13	R14	R15
43,7	80,0	71,8	29,8	43,7	71,0	61,9	4,9	-90,2	58,3	11,5	56,6	51,6	80,8	31,8

TM30 C values, 16 binned values out of total of 99 C values

C1	C2	C3	C4	C5	C6	C7	C8	C9	C10	C11	C12	C13	C14	C15	C16
52,7	58,7	64,8	80,0	76,6	57,4	48,5	52,2	60,5	57,3	78,4	88,9	82,7	64,9	60,2	59,8

CQS Q values

Q1	Q2	Q3	Q4	Q5	Q6	Q7	Q8	Q9	Q10	Q11	Q12	Q13	Q14	Q15
81,0	90,9	93,0	65,4	56,2	59,4	90,0	79,8	82,6	96,0	76,9	69,0	69,5	82,8	85,0

CQS: 75,3

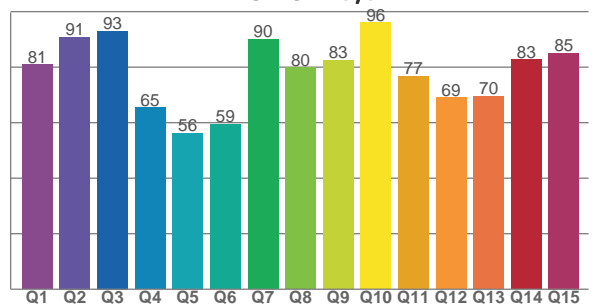

COLOR PARAMETERS

Color temperature	Color rendering index	Red component	Color fidelity	Color gamut	Color quality scale	Television lighting index	Color coordinate cie 1931	Color coordinate cie 1931	Color deviation from black body
CCT	CRI	CRI R9	TM30 Rf	TM30 Rg	CQS	TLCI	x	y	Δuv
3275 K	50,8	-90,2	65,7	127,9	75,3	36	0,399	0,350	-0,0176

TM30 DETAILS

Rf 65,7
Fidelity index Rf

Rg 127,9
Gammut index

Hue Bin	R _f	Graphic shifts (%)	
		Chroma	Hue
1	53	22%	-4%
2	59	17%	-11%
3	65	11%	-10%
4	80	7%	-1%
5	77	15%	8%
6	57	22%	13%
7	48	29%	3%
8	52	24%	-12%
9	60	17%	-18%
10	57	5%	-25%
11	78	-1%	-11%
12	89	0%	-1%
13	83	5%	10%
14	65	7%	25%
15	60	17%	17%
16	60	25%	3%

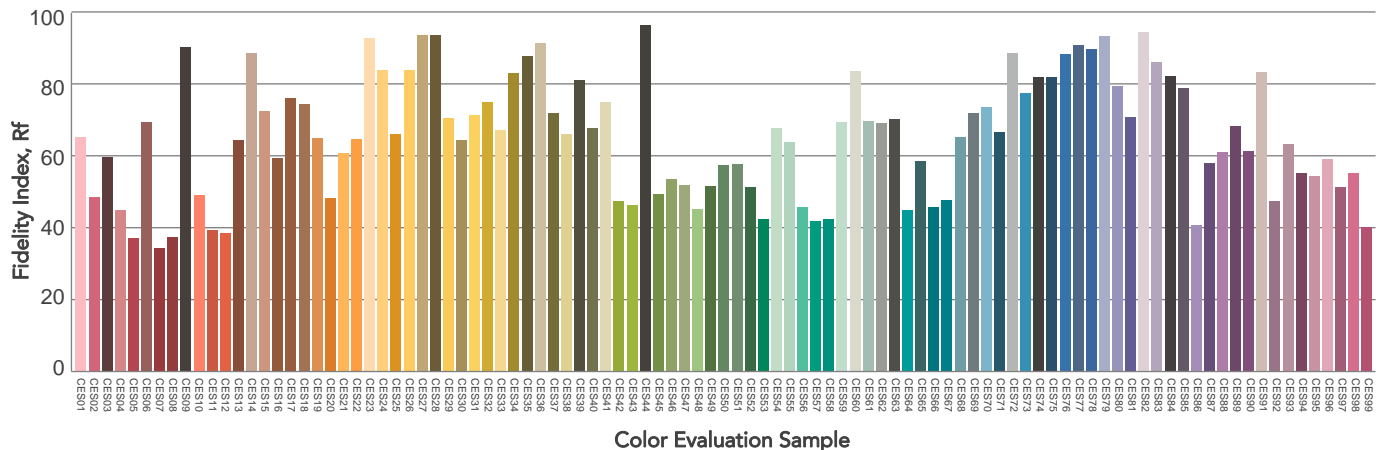
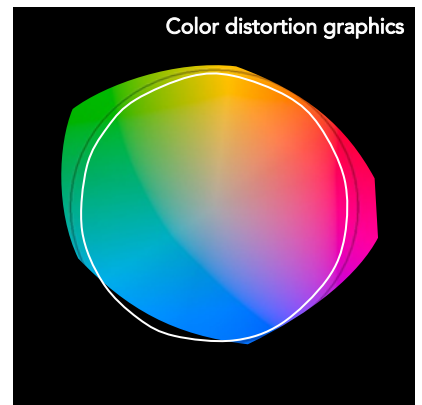
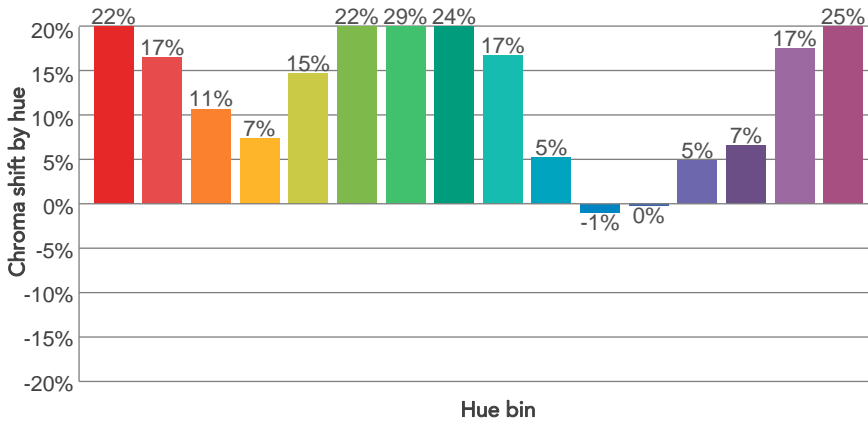
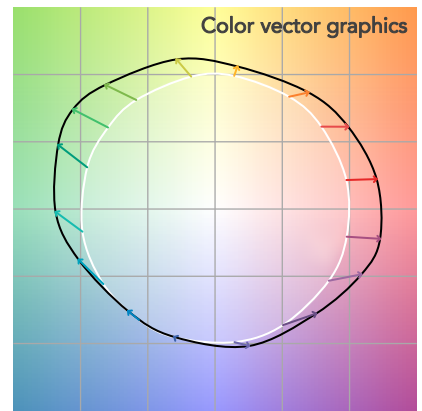
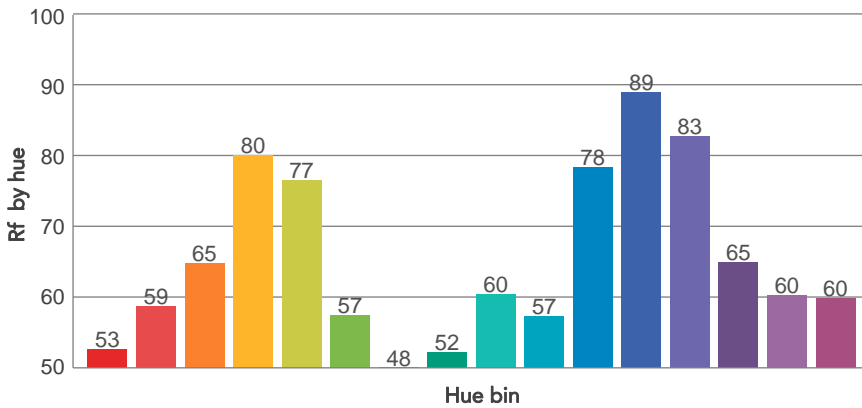
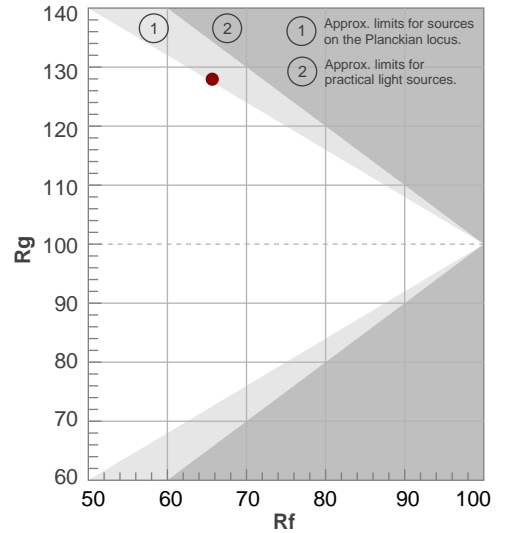

BEAM DETAILS



Beam angle 50%	Field angle 10%	Cut off angle 2,5%	Intensity ratio in 120° cone	Intensity ratio in 90° cone
18,2°	24,3°	26,8°	100,0%	100,0%

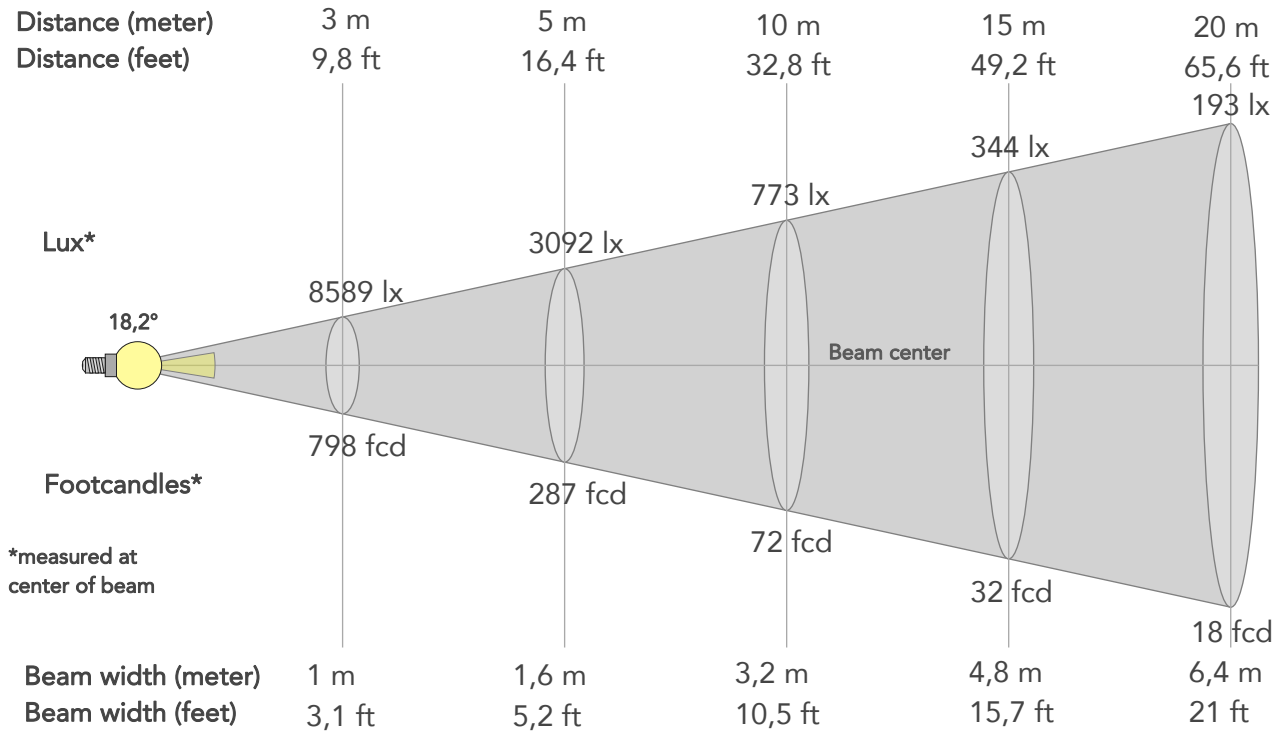

BEAM INTENSITIES AND WIDTHS

Distance	1m	2m	3m	4m	5m	7,5m	10m	15m	20m	25m	30m	40m	50m
Distance	3,3ft	6,6ft	9,8ft	13,1ft	16,4ft	24,6ft	32,8ft	49,2ft	65,6ft	82ft	98,4ft	131,2ft	164ft
Lux	77301lx	19325lx	8589lx	4831lx	3092lx	1374lx	773lx	344lx	193lx	124lx	86lx	48lx	31lx
Footcand.	7181fcd	1795fcd	798fcd	449fcd	287fcd	128fcd	72fcd	32fcd	18fcd	11fcd	8fcd	4fcd	3fcd
Beam wid.	0,3m	0,6m	1m	1,3m	1,6m	2,4m	3,2m	4,8m	6,4m	8m	9,6m	12,8m	16m
Beam wid.	1,1ft	2,1ft	3,1ft	4,2ft	5,2ft	7,9ft	10,5ft	15,7ft	21ft	26,2ft	31,5ft	42ft	52,4ft

LINEAR DISTRIBUTION DIAGRAM

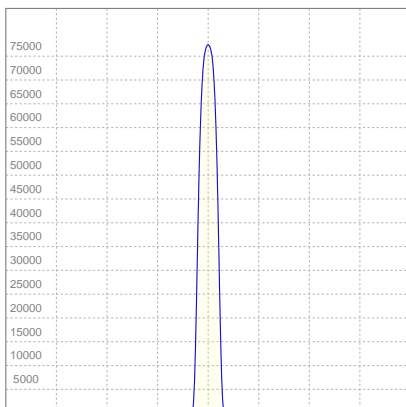

ELECTRICAL SPECIFICATIONS

Input voltage	Input current	Input power	Effeciency
222V	1,86A	386,5W	16lm/W

ISO CANDELA DIAGRAM

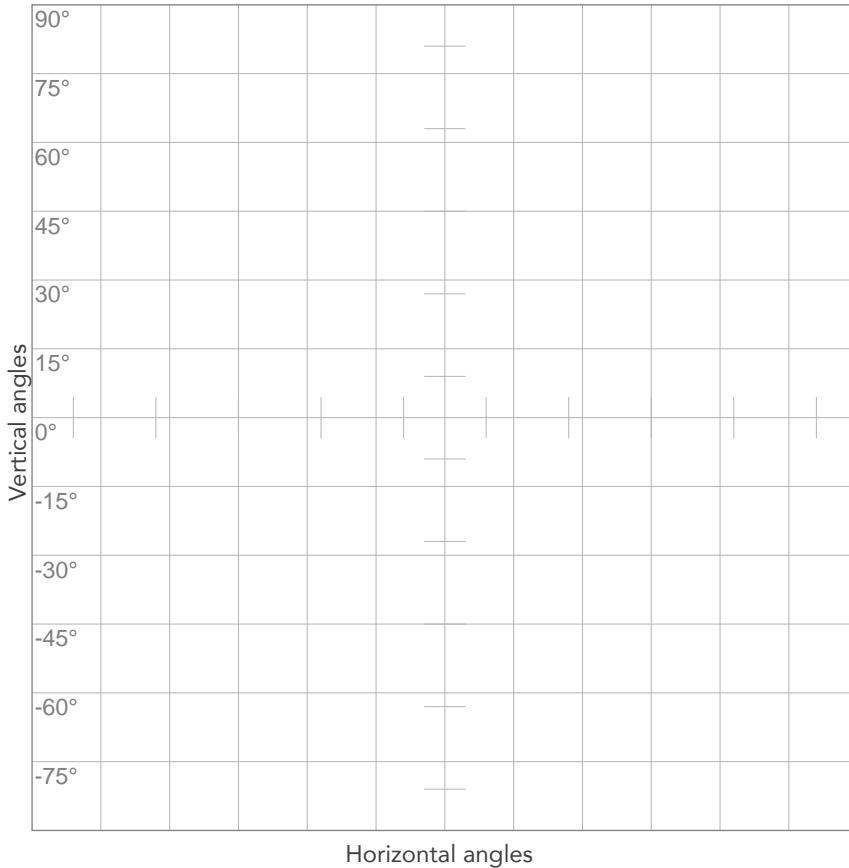

10%	7730 cd
20%	15460 cd
30%	23190 cd
40%	30920 cd
50%	38650 cd
60%	46380 cd
70%	54110 cd
80%	61841 cd

Conditions:
 Number of c-planes: 2
 Candela at center: 77301 cd

ISO LUX DIAGRAM

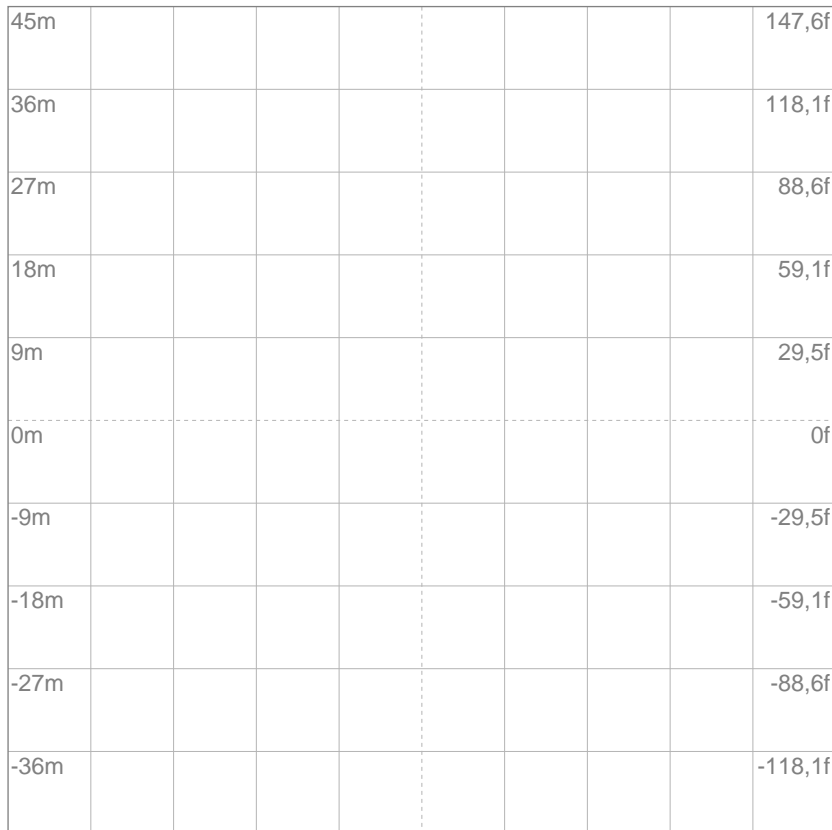

3%	23,2 lx
5%	38,7 lx
10%	77,3 lx
30%	232 lx
50%	387 lx

Conditions:
 Number of c-planes: 2
 Lux at center: 773 lx

Lux distribution on a surface when lamp is mounted at 10 meters from the surface.

Mounting height: 10 meters (33 feet)



Total lumen output:

4084 lm

Peak candela output:

814035 cd

Light quality:

CRI: 49,3

Color temperature:

3234 K

PRODUCT NAME:

ASTRAWASH19PIX

MEASUREMENT CONDITIONS:

Beam angle:

Min Zoom

Target:

3200K

Operator:

Paolo Carvone

Date and time:

15/02/2021 11:44:32

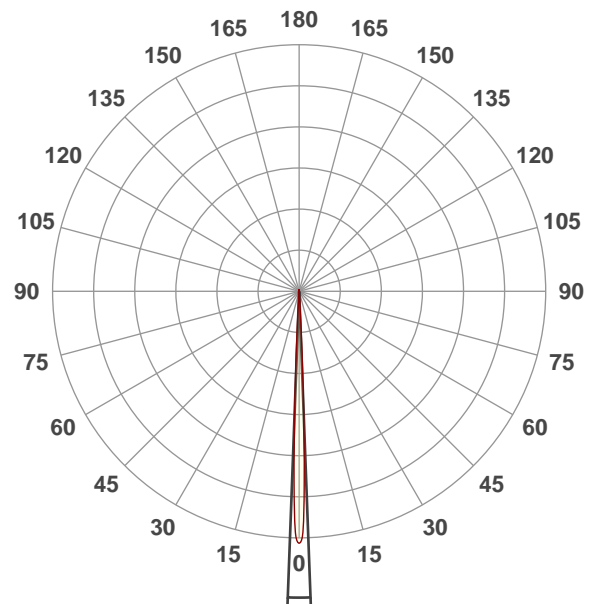

Spectra

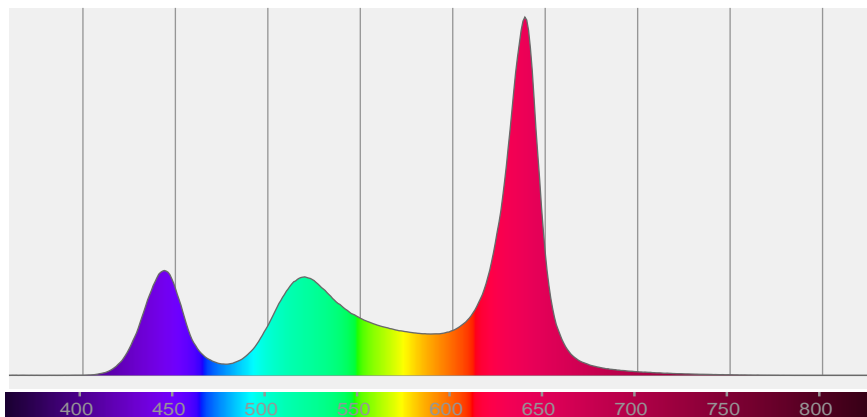

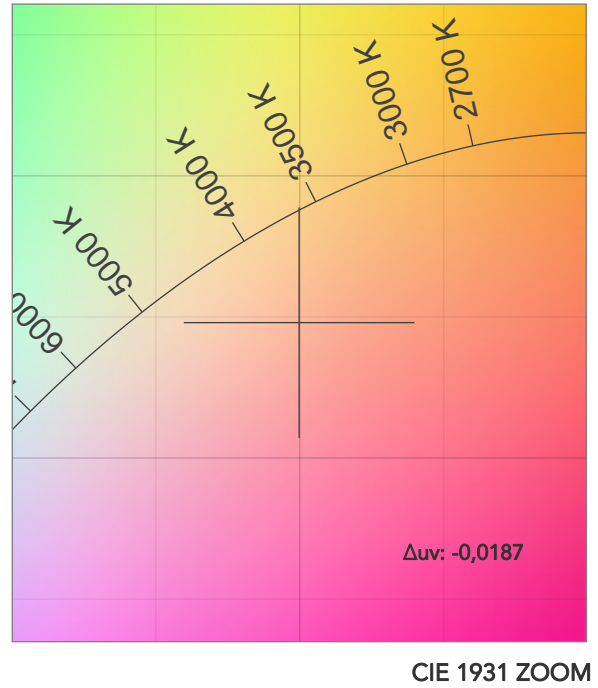
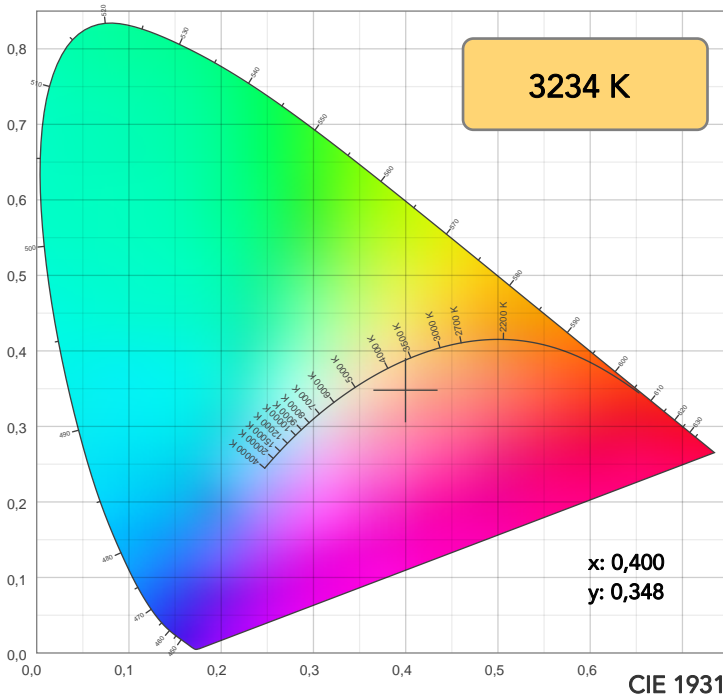

TM30: 64,7

CRI: 49,3 (R1-R8)

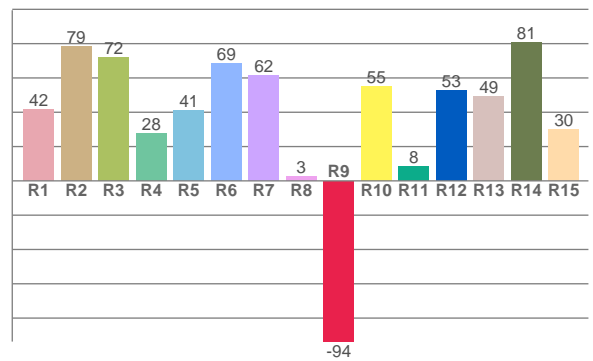
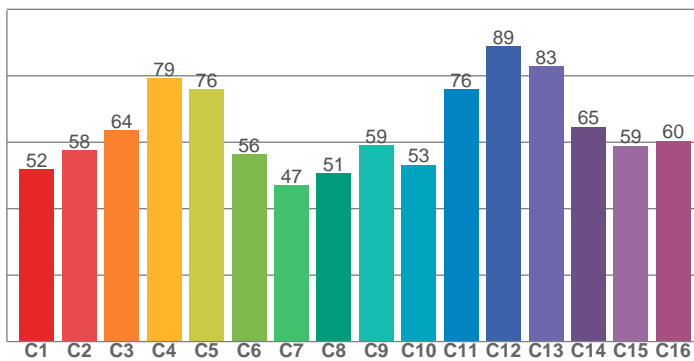

CRI R values, only R1-R8 are used to calculate final CRI value

R1	R2	R3	R4	R5	R6	R7	R8	R9	R10	R11	R12	R13	R14	R15
41,6	78,5	72,2	27,6	41,3	68,8	61,5	2,9	-93,7	55,1	8,4	52,8	49,5	80,9	29,8

TM30 C values, 16 binned values out of total of 99 C values

C1	C2	C3	C4	C5	C6	C7	C8	C9	C10	C11	C12	C13	C14	C15	C16
51,8	57,6	63,5	79,2	76,0	56,3	47,0	50,6	59,0	53,2	75,9	88,9	82,8	64,7	58,8	60,4

CQS Q values

Q1	Q2	Q3	Q4	Q5	Q6	Q7	Q8	Q9	Q10	Q11	Q12	Q13	Q14	Q15
80,7	90,7	92,3	63,8	54,7	58,2	89,6	79,5	82,5	95,6	76,0	68,3	69,0	82,2	84,6

CQS: 74,6

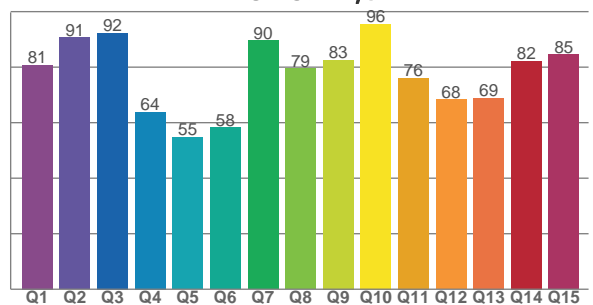

COLOR PARAMETERS

Color temperature	Color rendering index	Red component	Color fidelity	Color gamut	Color quality scale	Television lighting index	Color coordinate cie 1931	Color coordinate cie 1931	Color deviation from black body
CCT	CRI	CRI R9	TM30 Rf	TM30 Rg	CQS	TLCI	x	y	Δuv
3234 K	49,3	-93,7	64,7	128,4	74,6	34	0,400	0,348	-0,0187

TM30 DETAILS

Rf 64,7
Fidelity index Rf

Rg 128,4
Gammut index

Hue Bin	R _f	Graphic shifts (%)	
		Chroma	Hue
1	52	22%	-5%
2	58	17%	-11%
3	64	11%	-11%
4	79	8%	-1%
5	76	15%	8%
6	56	23%	13%
7	47	30%	3%
8	51	25%	-12%
9	59	17%	-19%
10	53	5%	-24%
11	76	-1%	-14%
12	89	0%	-1%
13	83	5%	10%
14	65	6%	25%
15	59	17%	16%
16	60	27%	7%

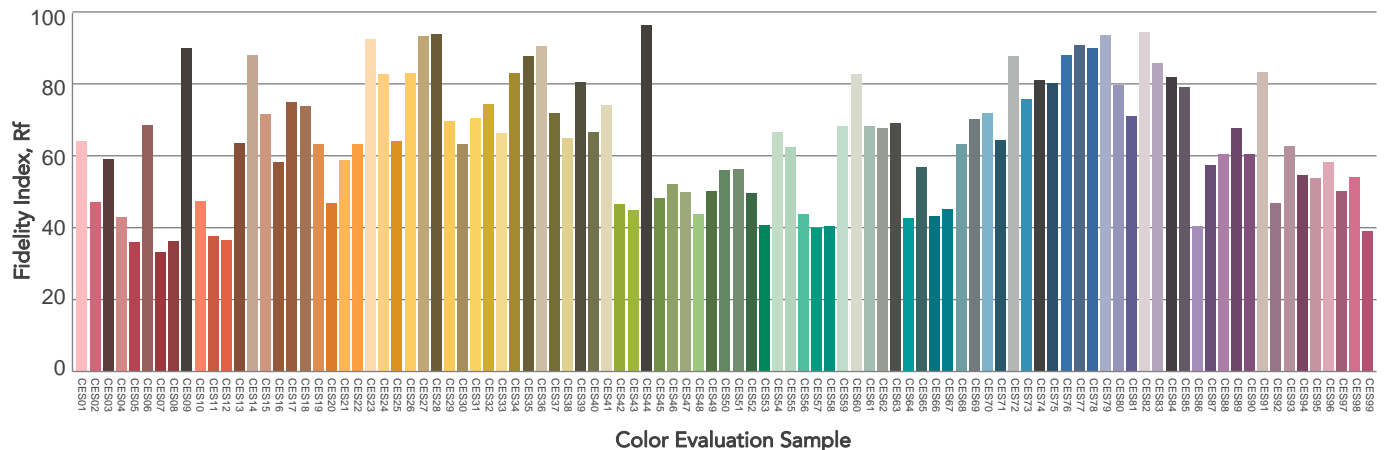
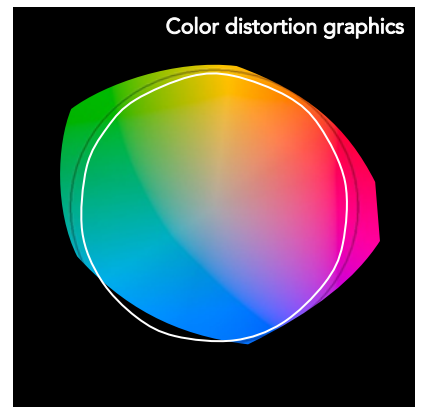
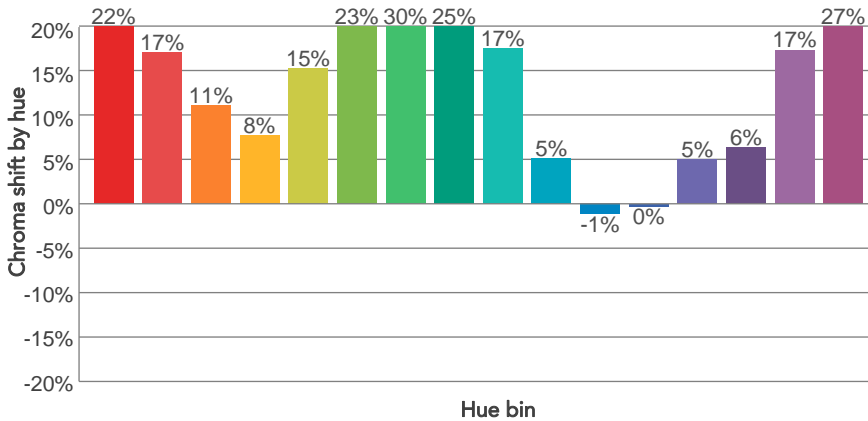
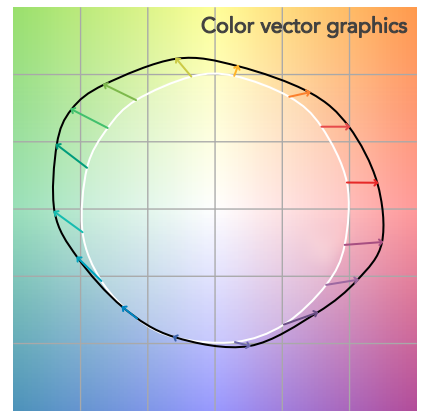
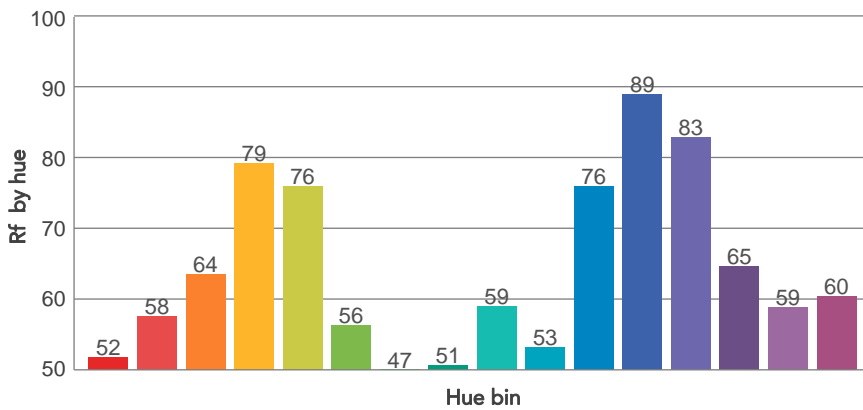
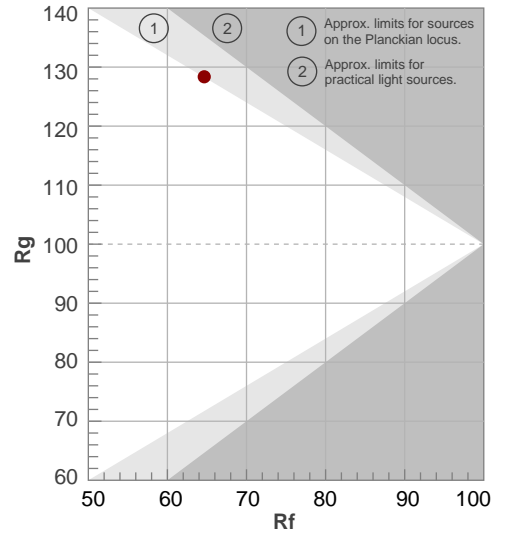

BEAM DETAILS



Beam angle 50%	Field angle 10%	Cut off angle 2,5%	Intensity ratio in 120° cone	Intensity ratio in 90° cone
4,3°	6,5°	7,4°	100,0%	100,0%

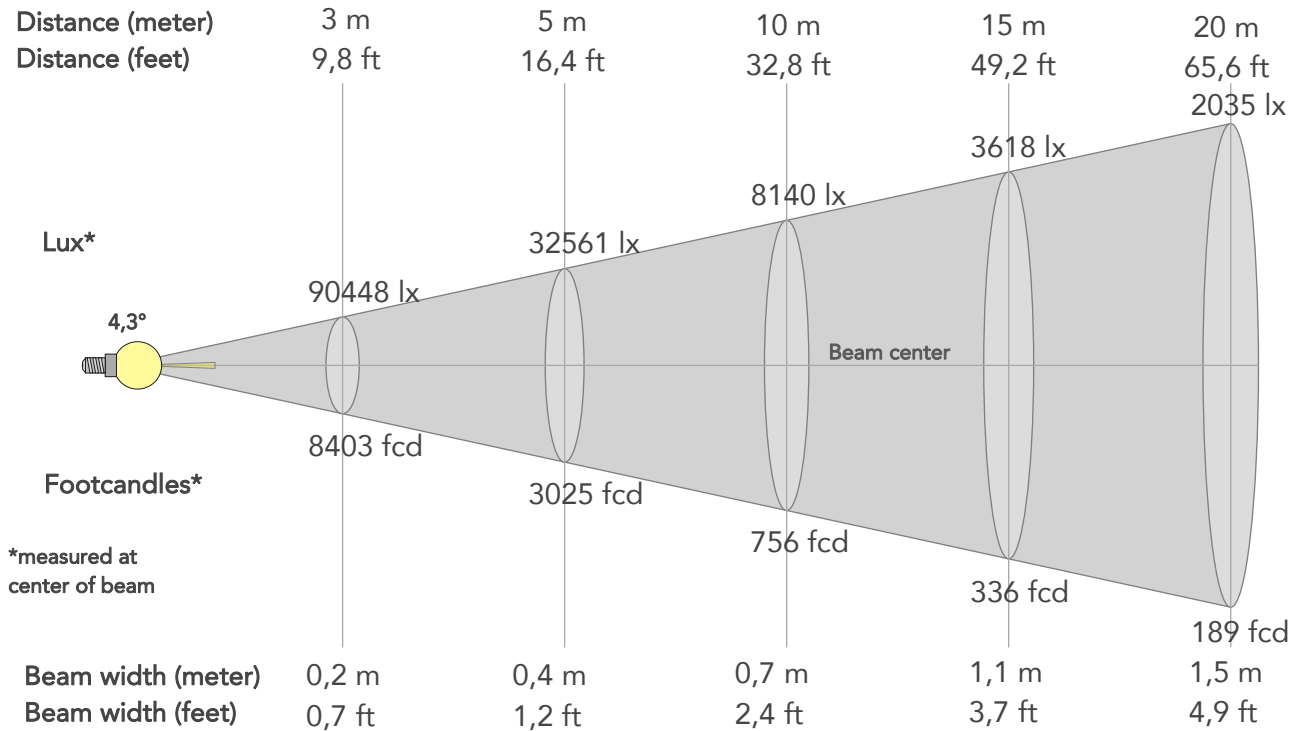

BEAM INTENSITIES AND WIDTHS

Distance	1m	2m	3m	4m	5m	7,5m	10m	15m	20m	25m	30m	40m	50m
Distance	3,3ft	6,6ft	9,8ft	13,1ft	16,4ft	24,6ft	32,8ft	49,2ft	65,6ft	82ft	98,4ft	131,2ft	164ft
Lux	814035lx	203509lx	90448lx	50877lx	32561lx	14472lx	8140lx	3618lx	2035lx	1302lx	904lx	509lx	326lx
Footcand.	75626fcd	18907fcd	8403fcd	4727fcd	3025fcd	1344fcd	756fcd	336fcd	189fcd	121fcd	84fcd	47fcd	30fcd
Beam wid.	0,1m	0,1m	0,2m	0,3m	0,4m	0,6m	0,7m	1,1m	1,5m	1,9m	2,2m	3m	3,7m
Beam wid.	0,2ft	0,5ft	0,7ft	1ft	1,2ft	1,8ft	2,4ft	3,7ft	4,9ft	6,1ft	7,3ft	9,7ft	12,2ft

LINEAR DISTRIBUTION DIAGRAM

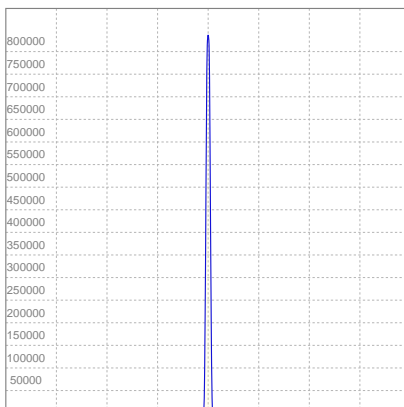

ELECTRICAL SPECIFICATIONS

Input voltage	Input current	Input power	Effeciency
223V	1,84A	384,5W	11lm/W

ISO CANDELA DIAGRAM

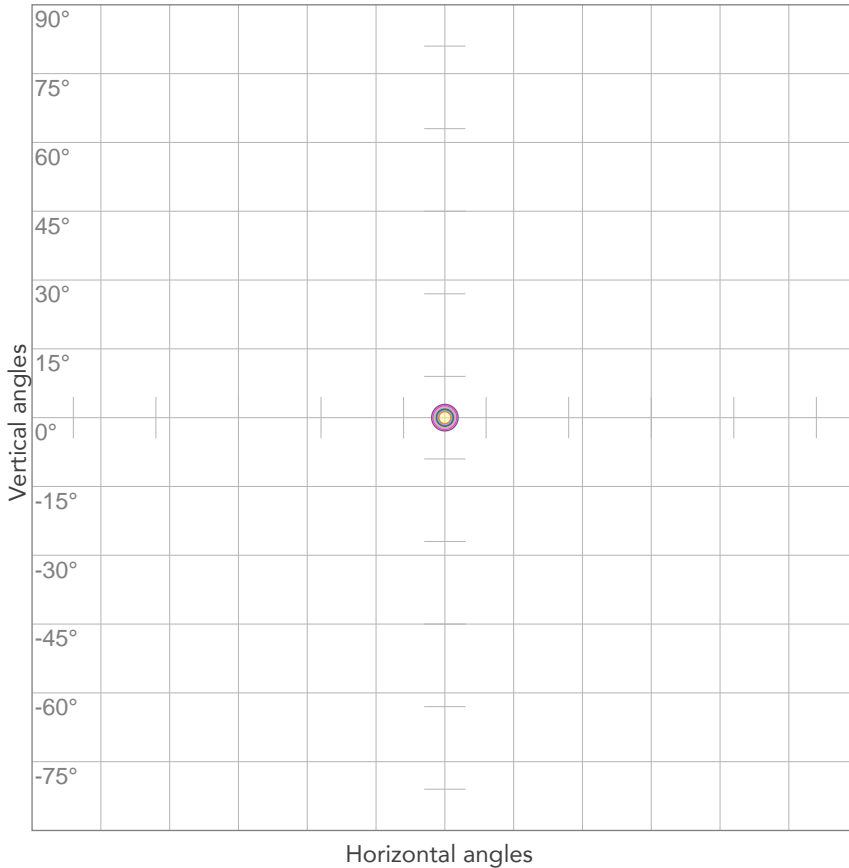

10%	81404 cd
20%	162807 cd
30%	244211 cd
40%	325614 cd
50%	407018 cd
60%	488421 cd
70%	569825 cd
80%	651228 cd

Conditions:

Number of c-planes: 2

Candela at center: 814035 cd

ISO LUX DIAGRAM

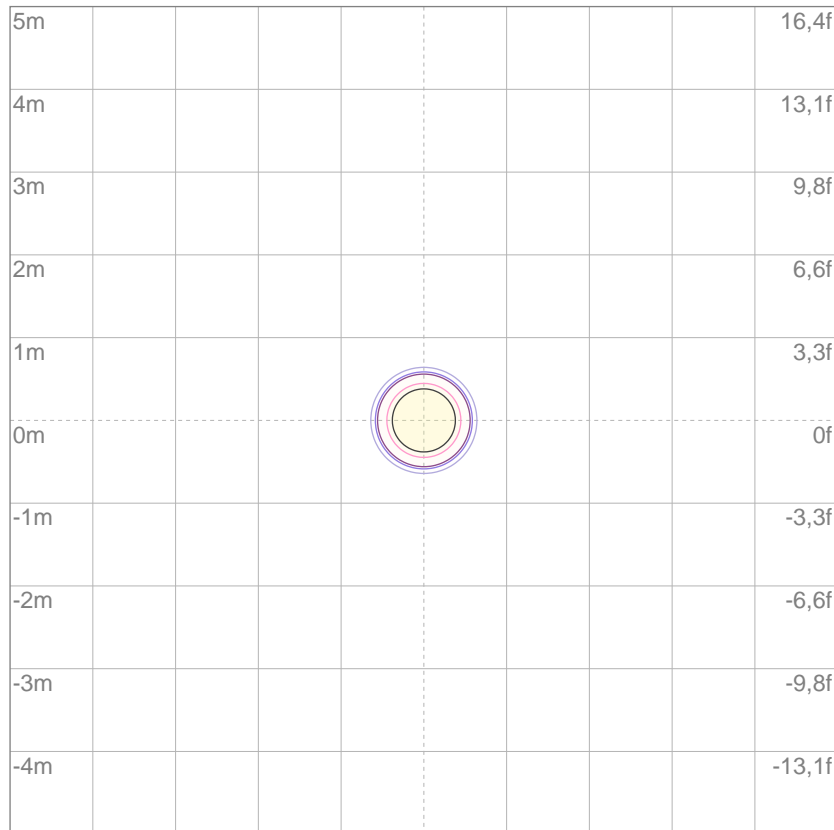

3%	244 lx
5%	407 lx
10%	814 lx
30%	2442 lx
50%	4070 lx

Conditions:

Number of c-planes: 2

Lux at center: 8140 lx

Lux distribution on a surface when lamp is mounted at 10 meters from the surface.

Mounting height: 10 meters (33 feet)



Total lumen output:

8606 lm

Peak candela output:

24908 cd

Light quality:

CRI: 58,2

Color temperature:

4082 K

PRODUCT NAME:

ASTRAWASH19PIX

MEASURAMENT CONDITIONS:

Beam angle:

Max Zoom

Target:

4000K

Operator:

Paolo Carvone

Date and time:

15/02/2021 12:22:17

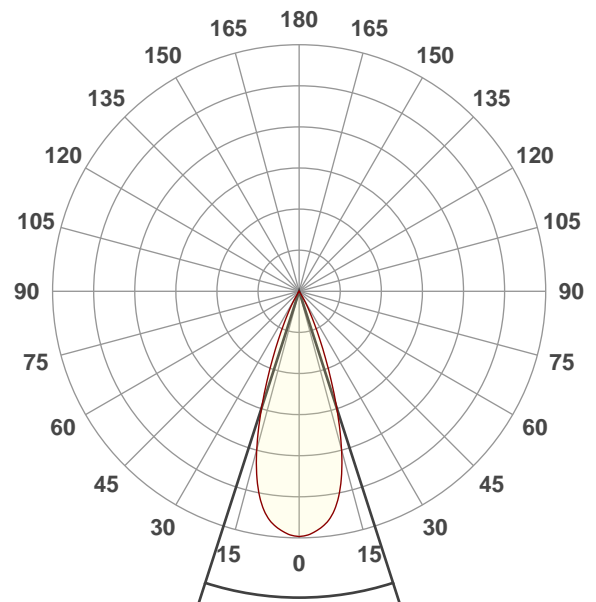

Beam angle 50%: 35,7°

Field angle 10%: 53,7°

Cut off angle 2.5%: 62,3°

Spectra

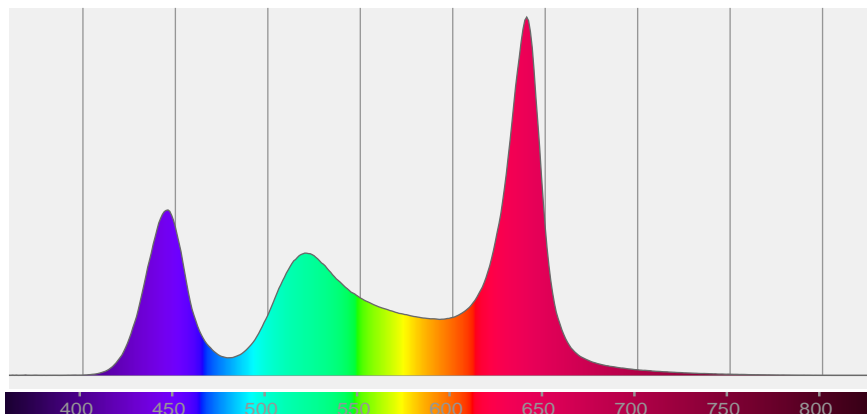

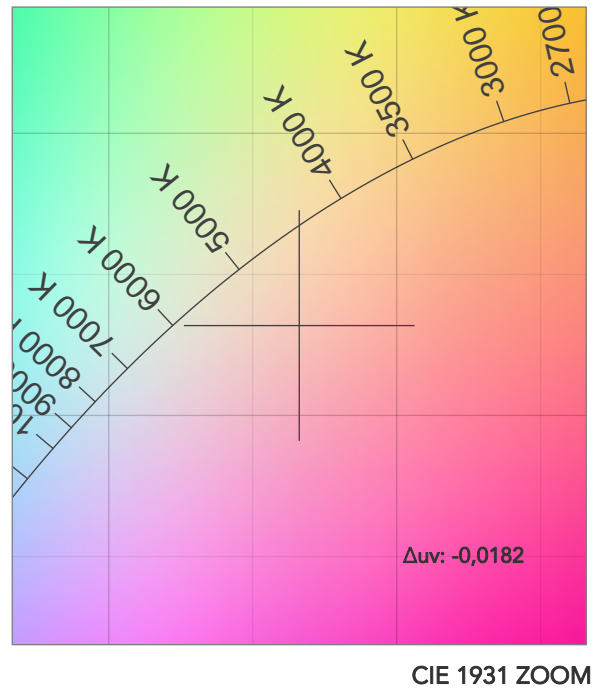
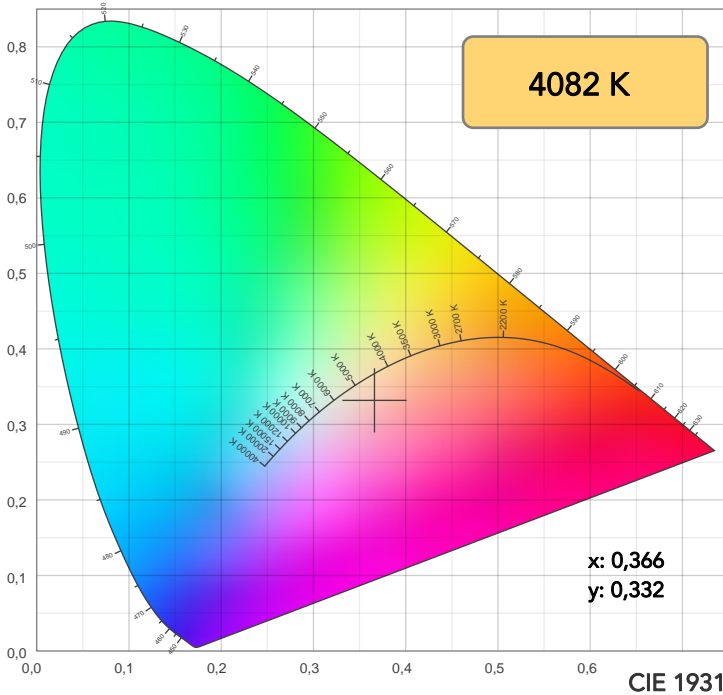

TM30: 70,7

CRI: 58,2 (R1-R8)

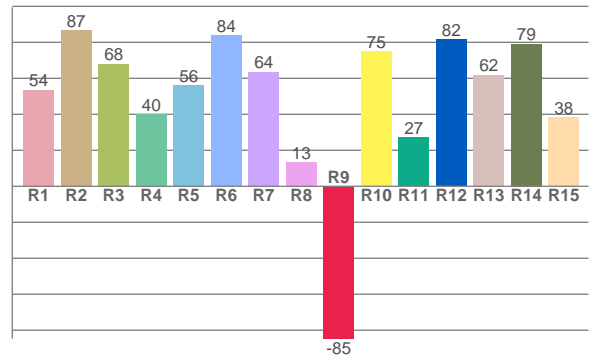
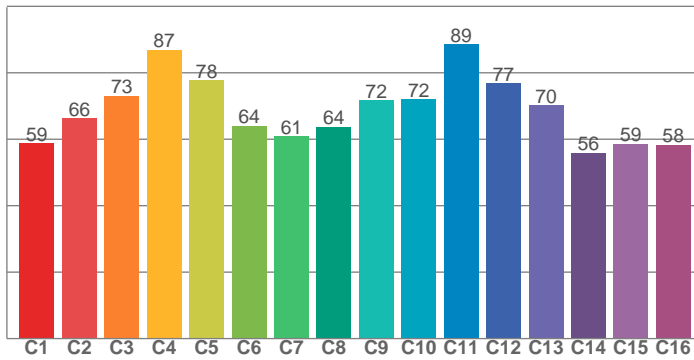

CRI R values, only R1-R8 are used to calculate final CRI value

R1	R2	R3	R4	R5	R6	R7	R8	R9	R10	R11	R12	R13	R14	R15
53,6	86,8	68,1	40,1	56,2	83,9	63,6	13,5	-84,6	75,0	27,1	81,6	62,0	79,1	38,2

TM30 C values, 16 binned values out of total of 99 C values

C1	C2	C3	C4	C5	C6	C7	C8	C9	C10	C11	C12	C13	C14	C15	C16
58,7	66,3	73,0	87,0	77,8	64,0	60,9	63,8	71,7	72,0	88,5	76,8	70,2	56,0	58,6	58,3

CQS Q values

Q1	Q2	Q3	Q4	Q5	Q6	Q7	Q8	Q9	Q10	Q11	Q12	Q13	Q14	Q15
80,3	89,0	90,7	81,3	68,6	70,2	94,6	80,3	78,9	96,0	86,1	77,3	75,7	85,3	86,4

CQS: 81,0

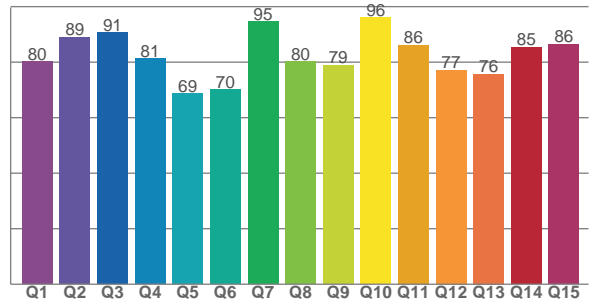

COLOR PARAMETERS

Color temperature	Color rendering index	Red component	Color fidelity	Color gamut	Color quality scale	Television lighting index	Color coordinate cie 1931	Color coordinate cie 1931	Color deviation from black body
CCT	CRI	CRI R9	TM30 Rf	TM30 Rg	CQS	TLCI	x	y	Δuv
4082 K	58,2	-84,6	70,7	125,1	81,0	48	0,366	0,332	-0,0182

TM30 DETAILS



Rf 70,7
Fidelity index Rf

Rg 125,1
Gammut index

Hue Bin	R _f	Graphic shifts (%)	
		Chroma	Hue
1	59	21%	-3%
2	66	13%	-10%
3	73	9%	-7%
4	87	5%	2%
5	78	11%	8%
6	64	20%	11%
7	61	23%	1%
8	64	19%	-6%
9	72	12%	-14%
10	72	3%	-15%
11	89	-1%	0%
12	77	1%	12%
13	70	2%	23%
14	56	10%	23%
15	59	20%	19%
16	58	24%	4%

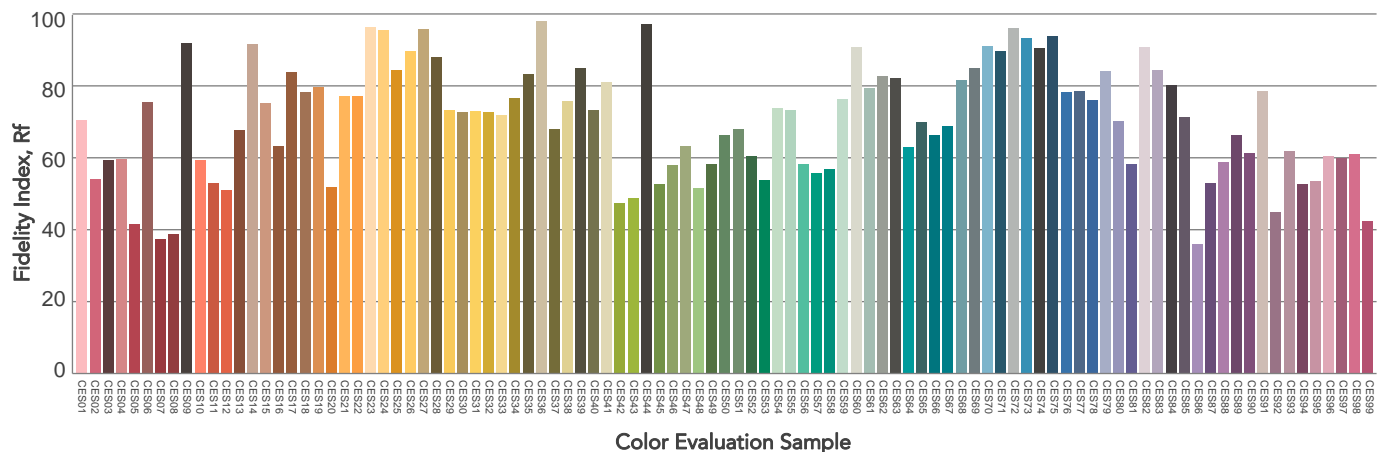
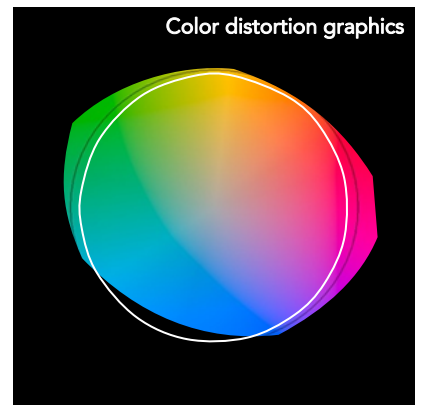
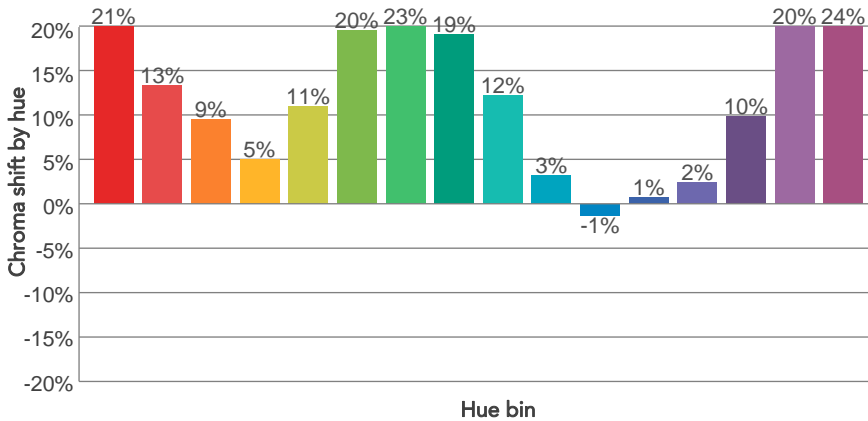
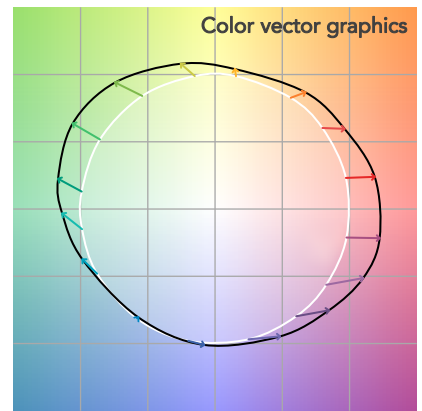
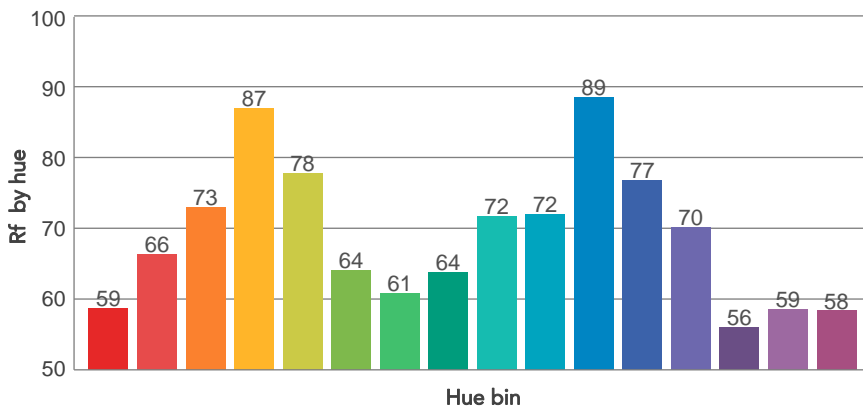
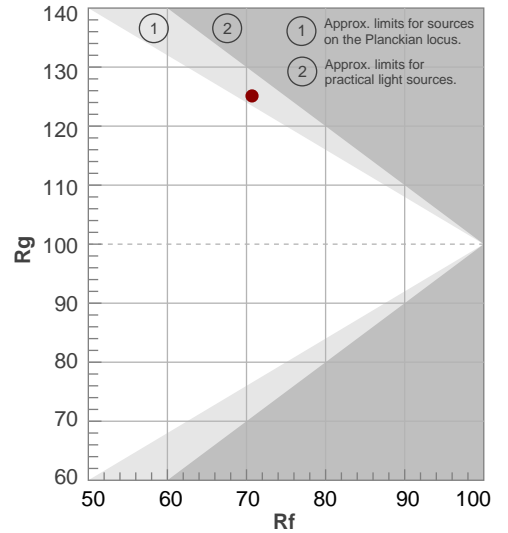

BEAM DETAILS



Beam angle 50%	Field angle 10%	Cut off angle 2,5%	Intensity ratio in 120° cone	Intensity ratio in 90° cone
35,7°	53,7°	62,3°	100,0%	100,0%

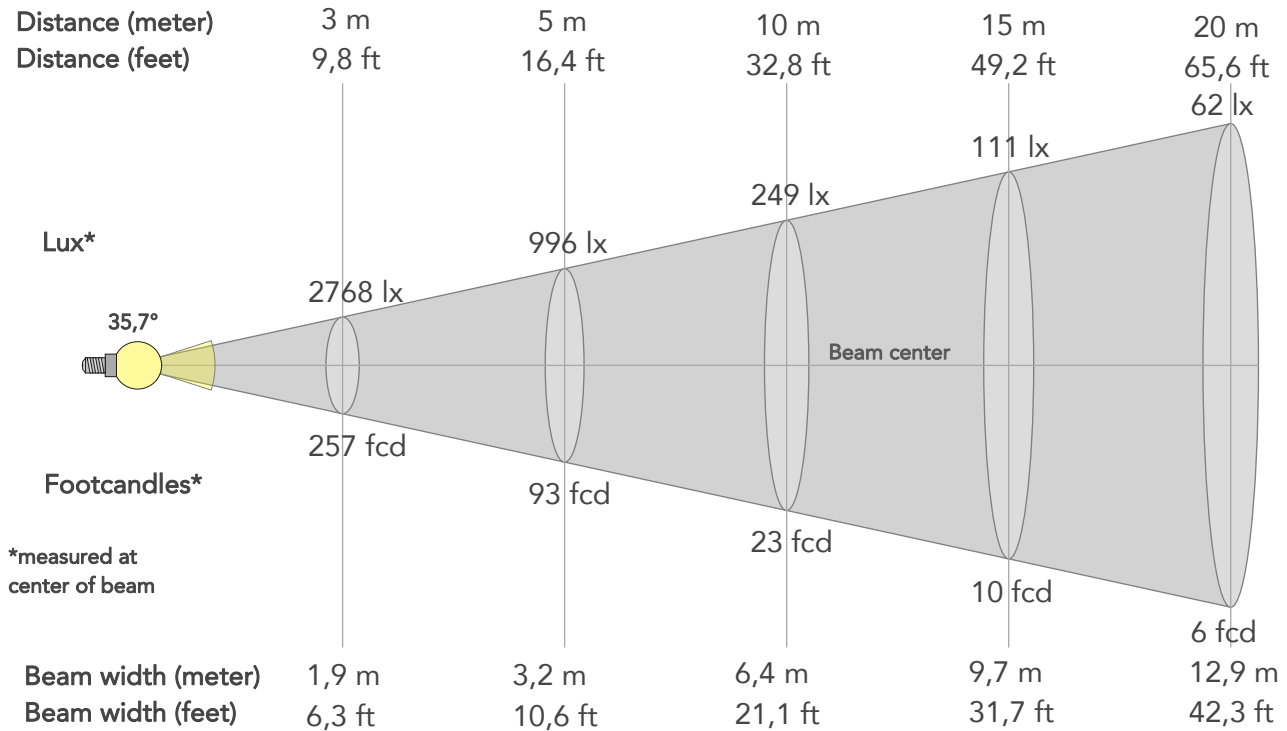

BEAM INTENSITIES AND WIDTHS

Distance	1m	2m	3m	4m	5m	7,5m	10m	15m	20m	25m	30m	40m	50m
Distance	3,3ft	6,6ft	9,8ft	13,1ft	16,4ft	24,6ft	32,8ft	49,2ft	65,6ft	82ft	98,4ft	131,2ft	164ft
Lux	24908lx	6227lx	2768lx	1557lx	996lx	443lx	249lx	111lx	62lx	40lx	28lx	16lx	10lx
Footcand.	2314fcd	578fcd	257fcd	145fcd	93fcd	41fcd	23fcd	10fcd	6fcd	4fcd	3fcd	1fcd	1fcd
Beam wid.	0,6m	1,3m	1,9m	2,6m	3,2m	4,8m	6,4m	9,7m	12,9m	16,1m	19,3m	25,8m	32,2m
Beam wid.	2,1ft	4,3ft	6,3ft	8,4ft	10,6ft	15,8ft	21,1ft	31,7ft	42,3ft	52,8ft	63,4ft	84,5ft	105,7ft

LINEAR DISTRIBUTION DIAGRAM

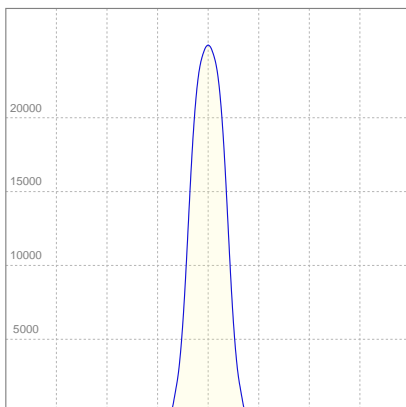

ELECTRICAL SPECIFICATIONS

Input voltage	Input current	Input power	Effeciency
224V	2,06A	436,3W	20lm/W

ISO CANDELA DIAGRAM

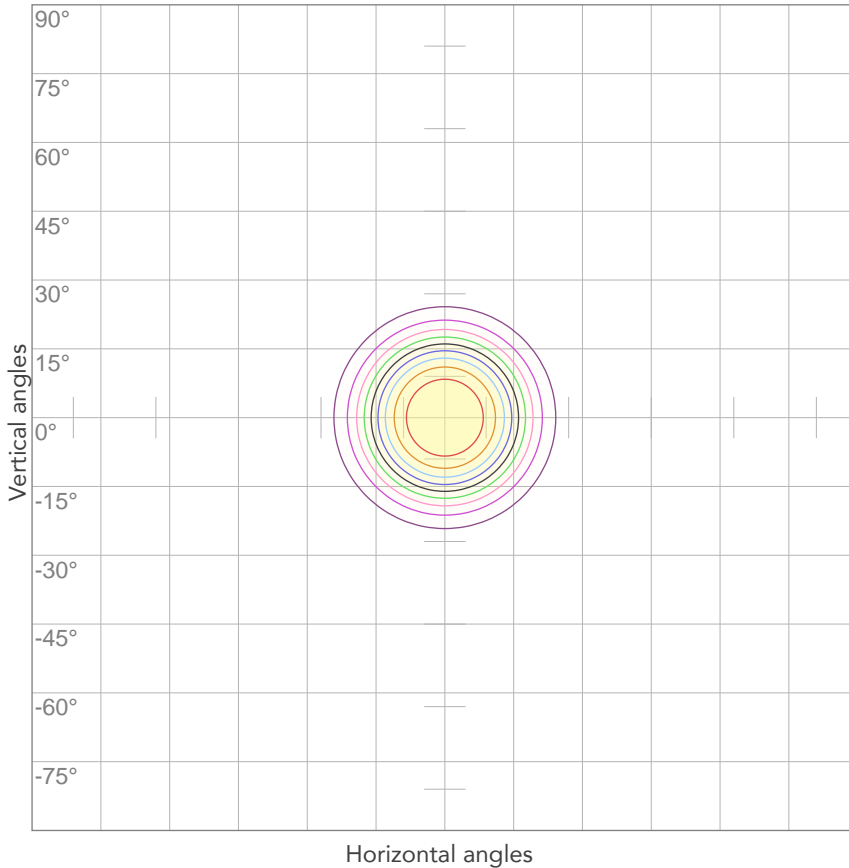

10%	2491 cd
20%	4982 cd
30%	7472 cd
40%	9963 cd
50%	12454 cd
60%	14945 cd
70%	17435 cd
80%	19926 cd

Conditions:

Number of c-planes: 2

Candela at center: 24908 cd

ISO LUX DIAGRAM

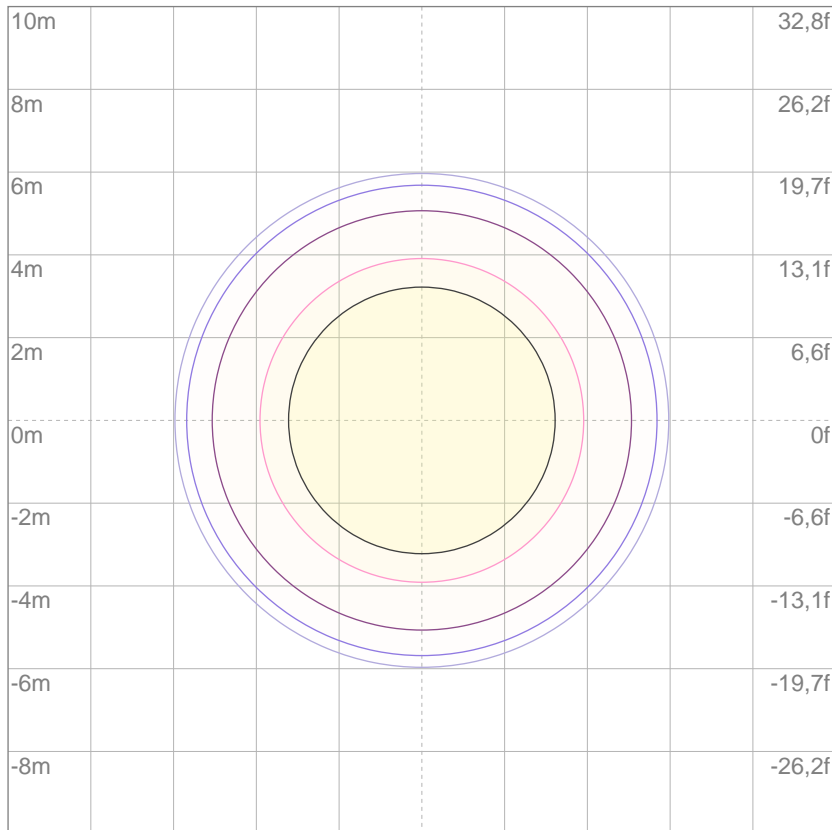

3%	7,47 lx
5%	12,5 lx
10%	24,9 lx
30%	74,7 lx
50%	125 lx

Conditions:

Number of c-planes: 2

Lux at center: 249 lx

Lux distribution on a surface when lamp is mounted at 10 meters from the surface.

Mounting height: 10 meters (33 feet)



Total lumen output:

7382 lm

Peak candela output:

91574 cd

Light quality:

CRI: 57,3

Color temperature:

4057 K

PRODUCT NAME:

ASTRAWASH19PIX

MEASUREMENT CONDITIONS:

Beam angle:

Med Zoom

Target:

4000K

Operator:

Paolo Carvone

Date and time:

15/02/2021 12:14:02

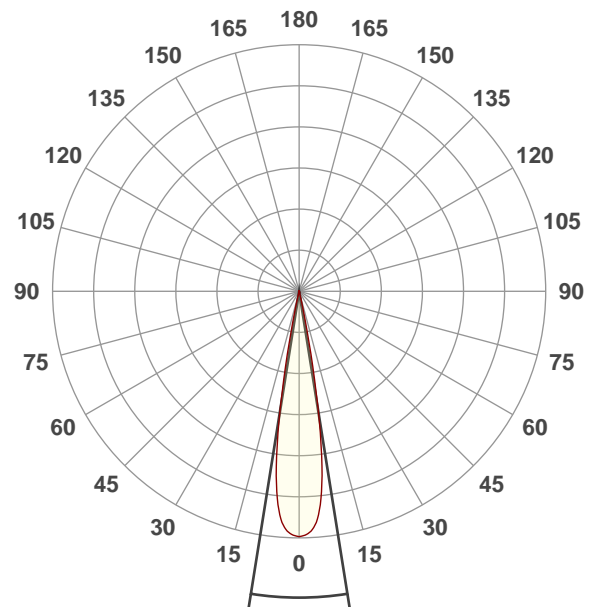

Spectra

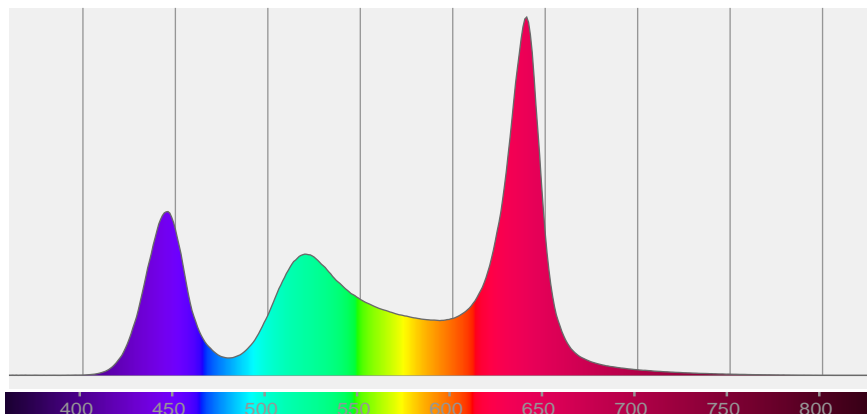

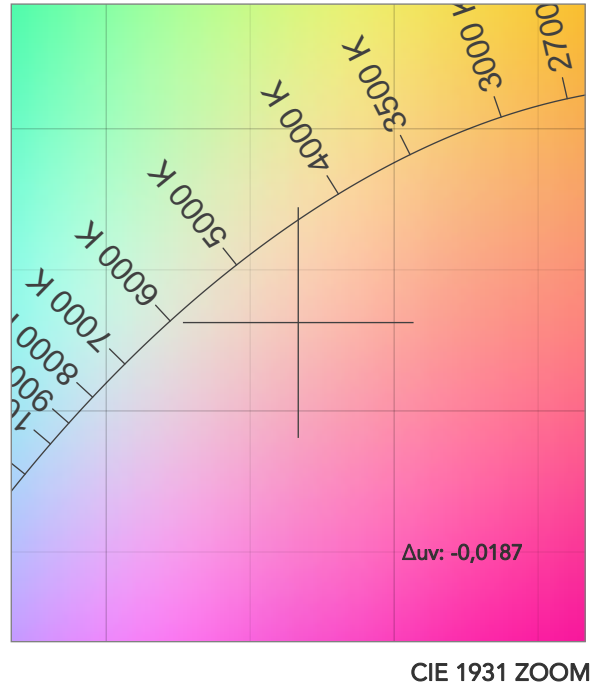
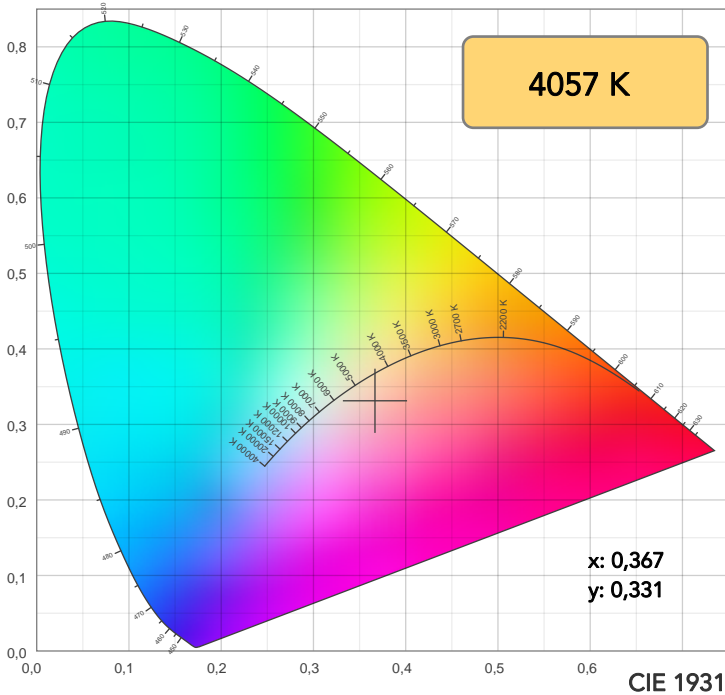

TM30: 70,3

CRI: 57,3 (R1-R8)

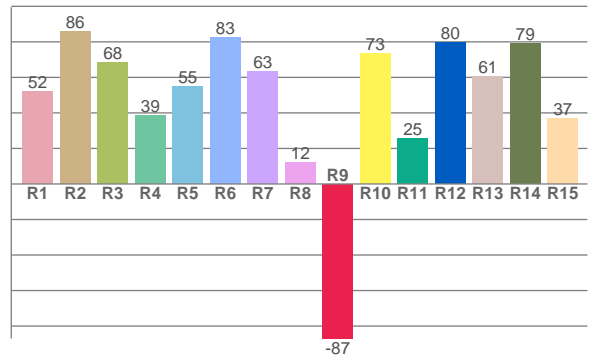
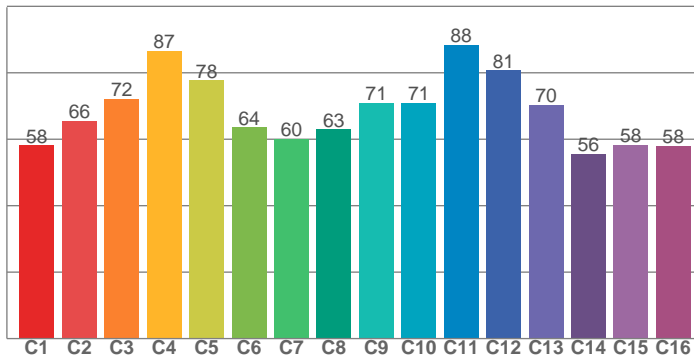

CRI R values, only R1-R8 are used to calculate final CRI value

R1	R2	R3	R4	R5	R6	R7	R8	R9	R10	R11	R12	R13	R14	R15
52,4	86,1	68,3	38,8	54,8	82,6	63,3	12,2	-87,0	73,3	25,4	79,7	60,8	79,2	36,9

TM30 C values, 16 binned values out of total of 99 C values

C1	C2	C3	C4	C5	C6	C7	C8	C9	C10	C11	C12	C13	C14	C15	C16
58,1	65,6	72,2	86,7	77,7	63,6	60,1	63,0	70,9	70,9	88,3	80,8	70,4	55,6	58,3	57,9

CQS Q values

Q1	Q2	Q3	Q4	Q5	Q6	Q7	Q8	Q9	Q10	Q11	Q12	Q13	Q14	Q15
80,1	89,0	91,3	80,2	67,8	69,7	94,7	79,9	78,9	96,4	85,5	76,6	75,2	85,1	86,1

CQS: 80,6

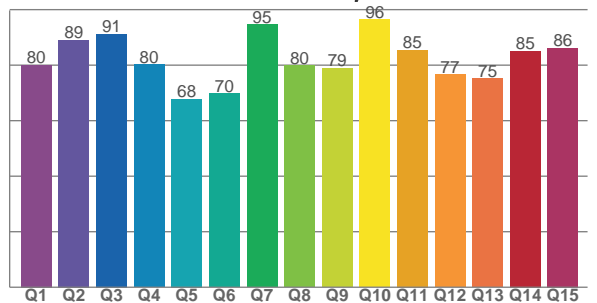

COLOR PARAMETERS

Color temperature	Color rendering index	Red component	Color fidelity	Color gamut	Color quality scale	Television lighting index	Color coordinate cie 1931	Color coordinate cie 1931	Color deviation from black body
CCT	CRI	CRI R9	TM30 Rf	TM30 Rg	CQS	TLCI	x	y	Δuv
4057 K	57,3	-87,0	70,3	125,6	80,6	47	0,367	0,331	-0,0187

TM30 DETAILS

Rf 70,3
Fidelity index Rf

Rg 125,6
Gammut index

Hue Bin	R _f	Graphic shifts (%)	
		Chroma	Hue
1	58	21%	-3%
2	66	14%	-10%
3	72	10%	-7%
4	87	5%	2%
5	78	11%	8%
6	64	20%	11%
7	60	24%	2%
8	63	20%	-6%
9	71	13%	-15%
10	71	3%	-15%
11	88	-1%	0%
12	81	2%	9%
13	70	3%	22%
14	56	10%	23%
15	58	20%	20%
16	58	24%	5%

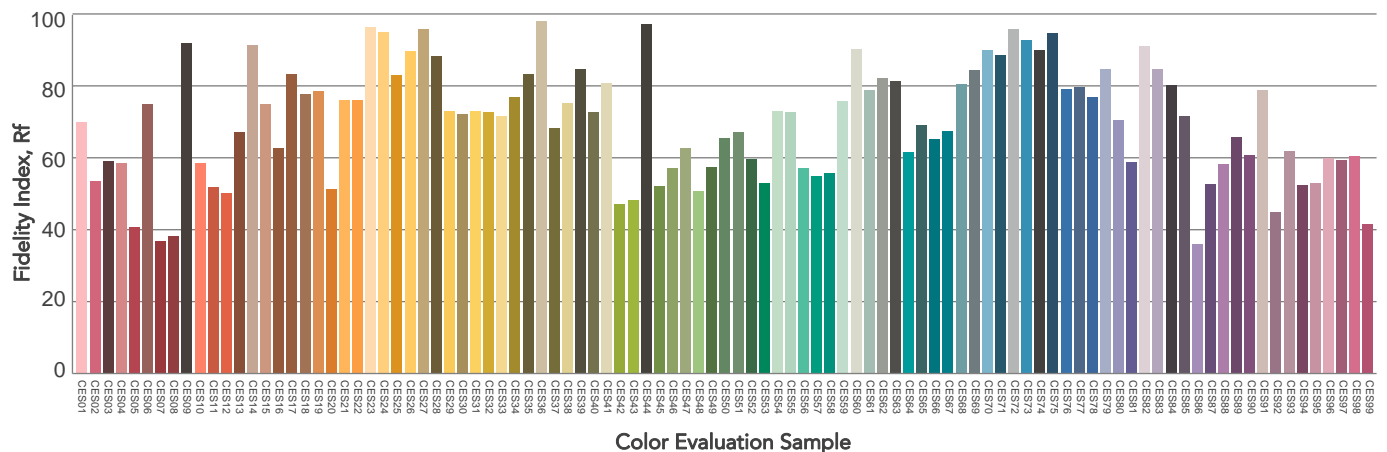
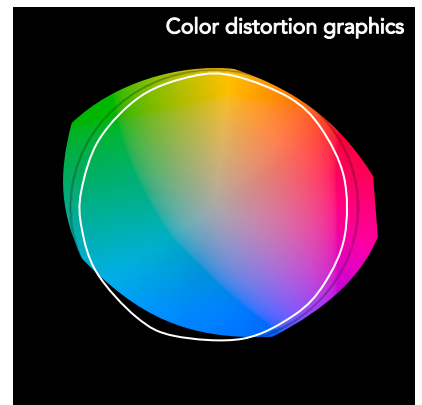
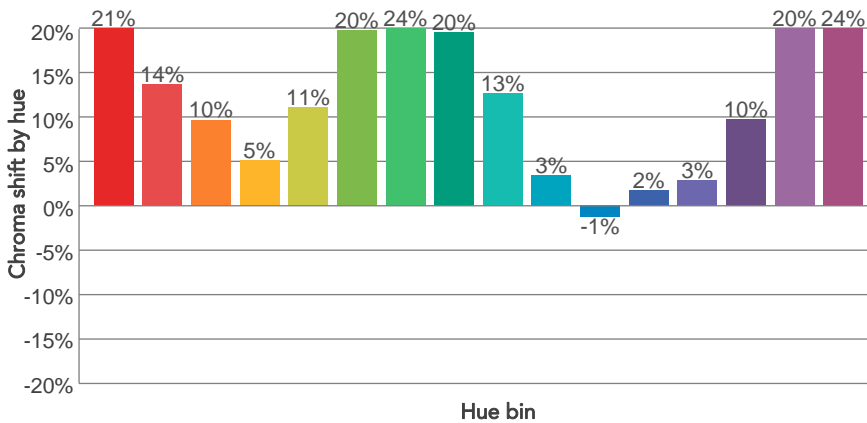
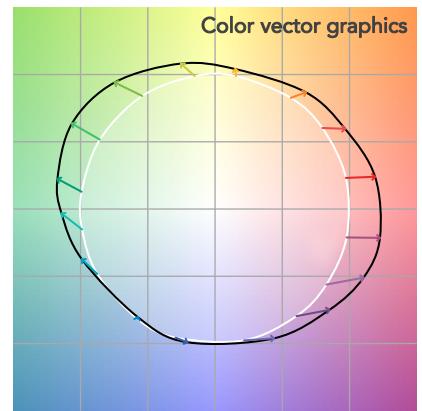
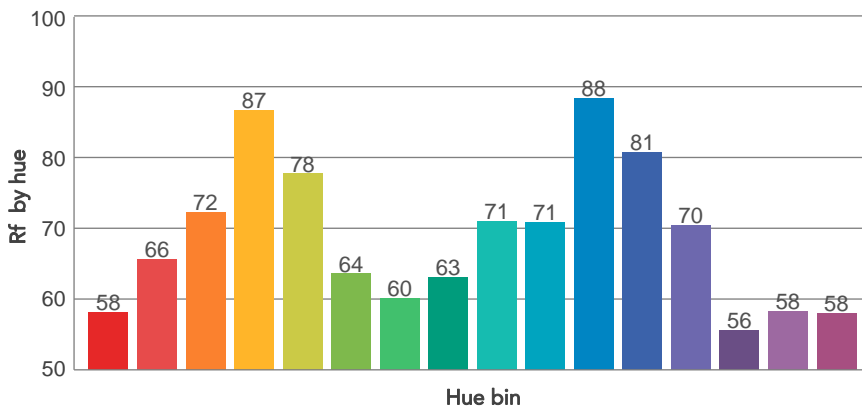
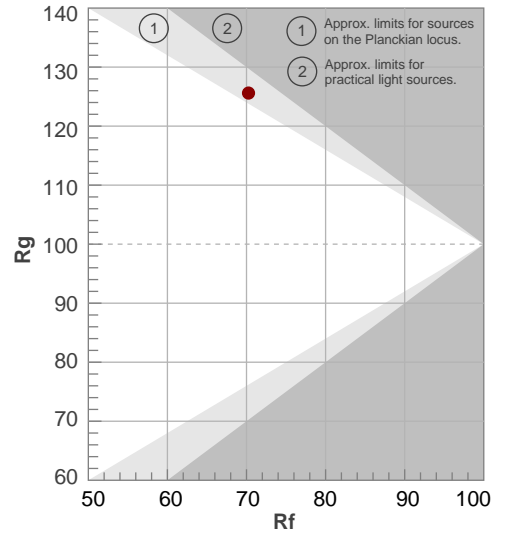

BEAM DETAILS



Beam angle 50%	Field angle 10%	Cut off angle 2,5%	Intensity ratio in 120° cone	Intensity ratio in 90° cone
18,1°	24,2°	26,5°	100,0%	100,0%

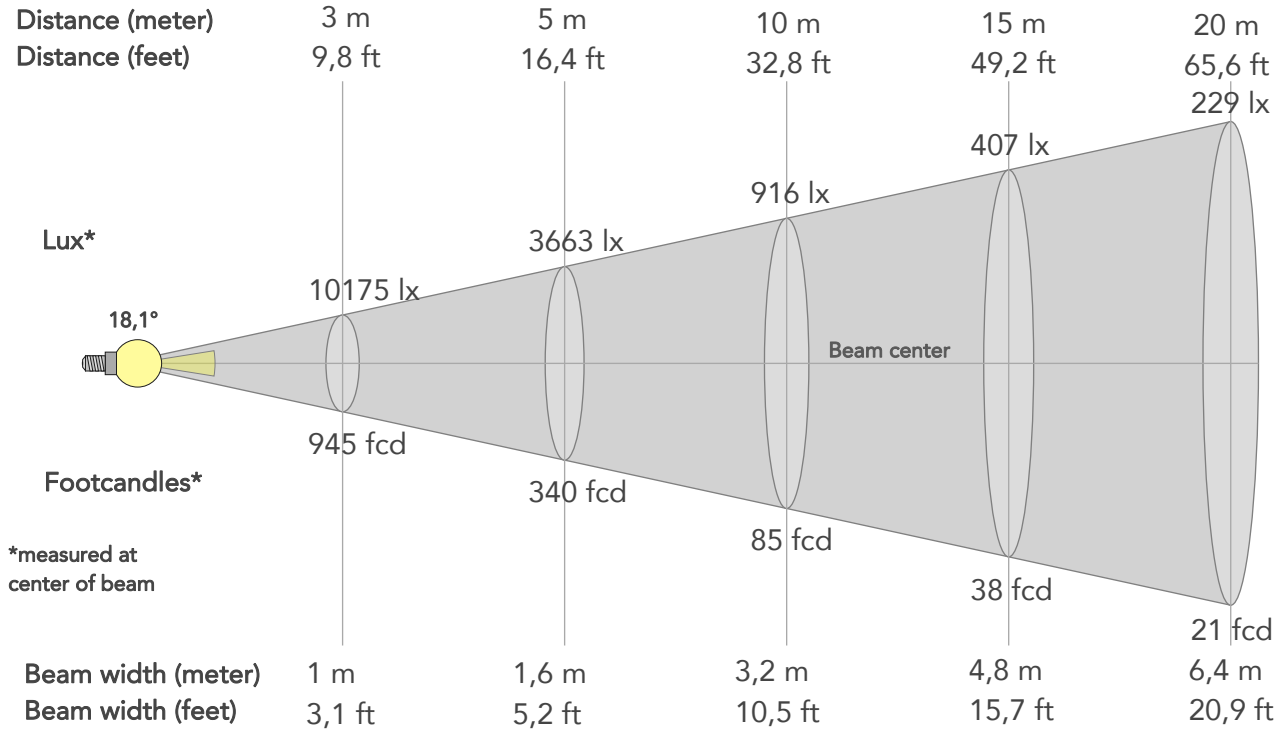

BEAM INTENSITIES AND WIDTHS

Distance	1m	2m	3m	4m	5m	7,5m	10m	15m	20m	25m	30m	40m	50m
Distance	3,3ft	6,6ft	9,8ft	13,1ft	16,4ft	24,6ft	32,8ft	49,2ft	65,6ft	82ft	98,4ft	131,2ft	164ft
Lux	91574lx	22894lx	10175lx	5723lx	3663lx	1628lx	916lx	407lx	229lx	147lx	102lx	57lx	37lx
Footcand.	8508fcd	2127fcd	945fcd	532fcd	340fcd	151fcd	85fcd	38fcd	21fcd	14fcd	9fcd	5fcd	3fcd
Beam wid.	0,3m	0,6m	1m	1,3m	1,6m	2,4m	3,2m	4,8m	6,4m	8m	9,6m	12,8m	16m
Beam wid.	1,1ft	2,1ft	3,1ft	4,2ft	5,2ft	7,8ft	10,5ft	15,7ft	20,9ft	26,2ft	31,4ft	41,9ft	52,3ft

LINEAR DISTRIBUTION DIAGRAM

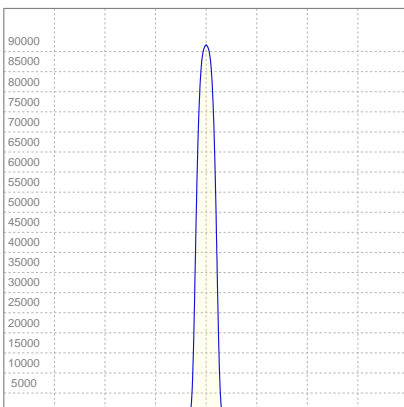

ELECTRICAL SPECIFICATIONS

Input voltage	Input current	Input power	Effeciency
224V	2,08A	437,9W	17lm/W

ISO CANDELA DIAGRAM

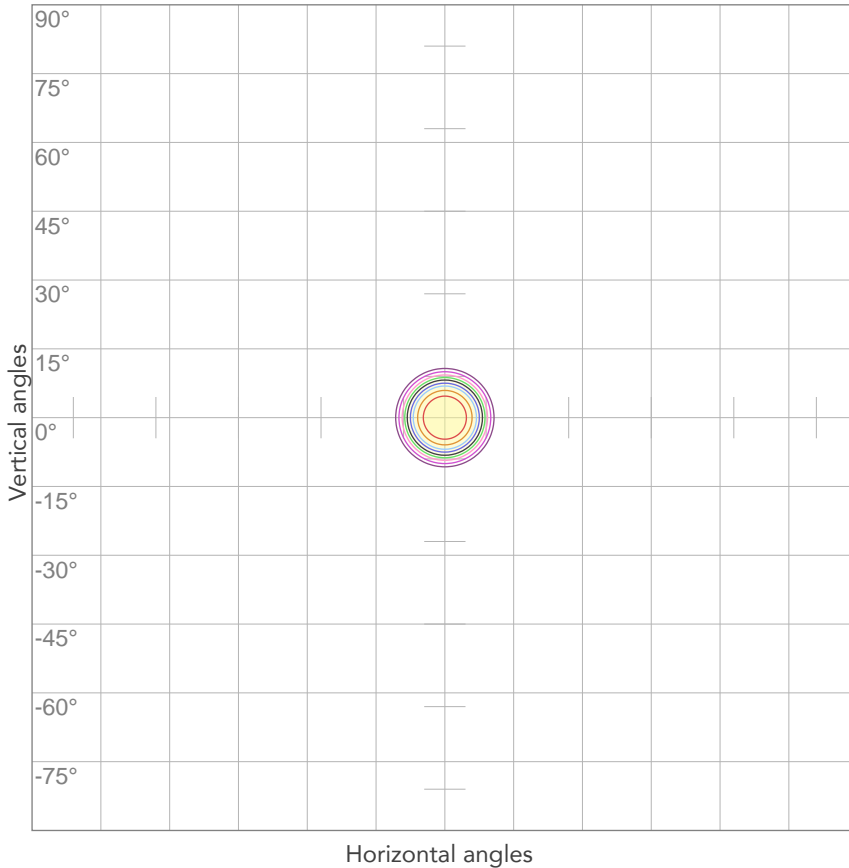

10%	9157 cd
20%	18315 cd
30%	27472 cd
40%	36630 cd
50%	45787 cd
60%	54945 cd
70%	64102 cd
80%	73259 cd

Conditions:

Number of c-planes: 2

Candela at center: 91574 cd

ISO LUX DIAGRAM

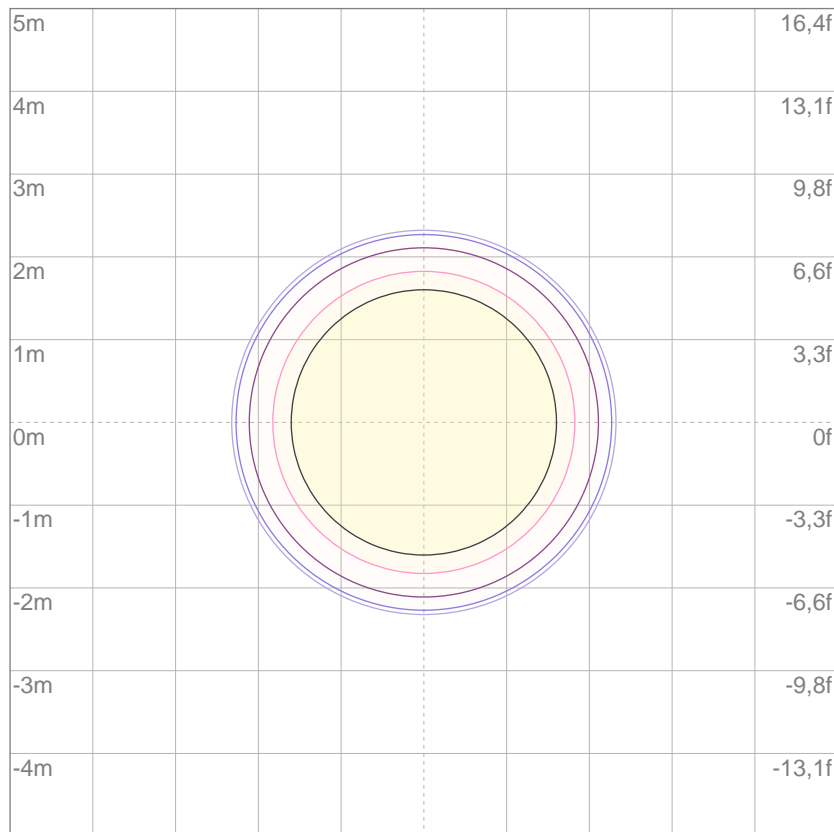

Mounting height: 10 meters (33 feet)

3%	27,5 lx
5%	45,8 lx
10%	91,6 lx
30%	275 lx
50%	458 lx

Conditions:

Number of c-planes: 2

Lux at center: 916 lx

Lux distribution on a surface when lamp is mounted at 10 meters from the surface.



Total lumen output:

4800 lm

Peak candela output:

960954 cd

Light quality:

CRI: 55,5

Color temperature:

4048 K

PRODUCT NAME:

ASTRAWASH19PIX

MEASUREMENT CONDITIONS:

Beam angle:

Min Zoom

Target:

4000K

Operator:

Paolo Carvone

Date and time:

15/02/2021 11:49:07

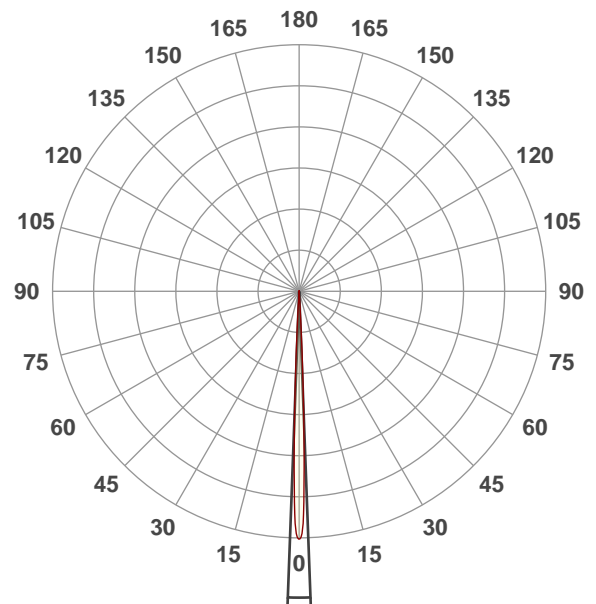

Beam angle 50%: 4,2°

Field angle 10%: 6,5°

Cut off angle 2.5%: 7,3°

Spectra

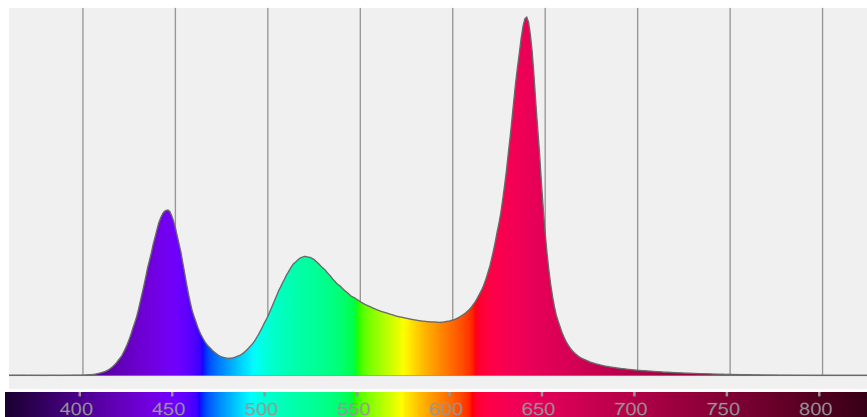

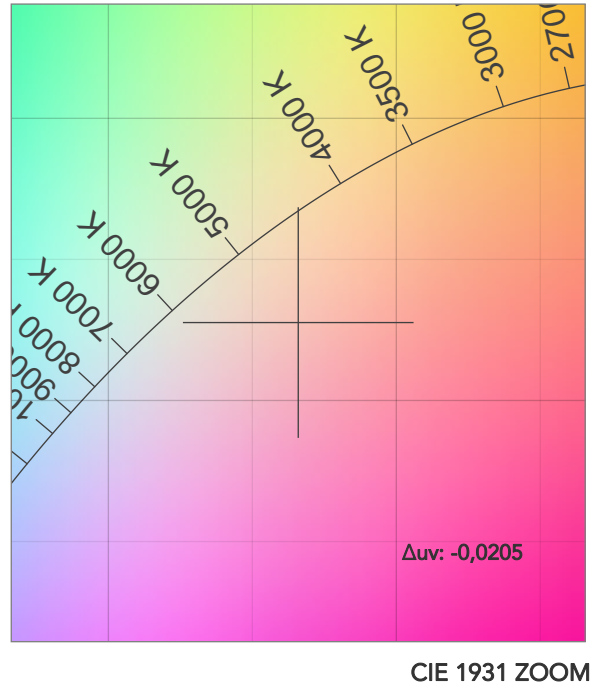
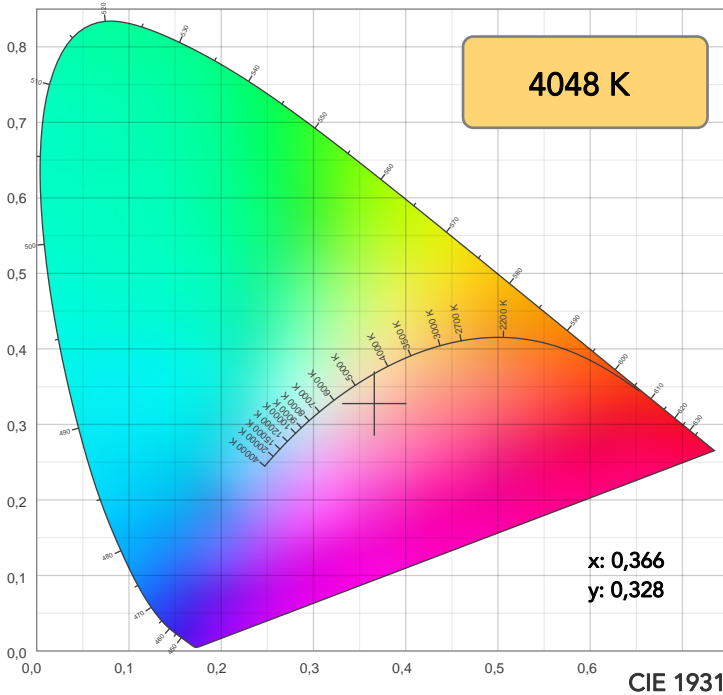

TM30: 69,3

CRI: 55,5 (R1-R8)

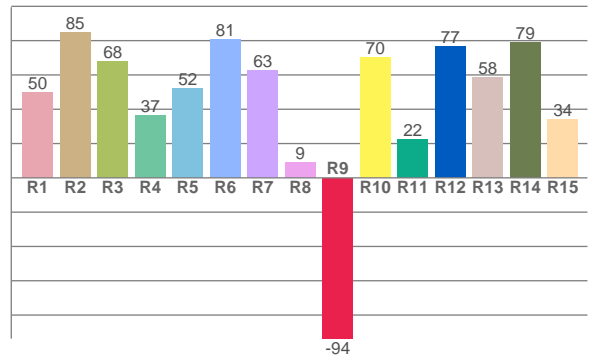
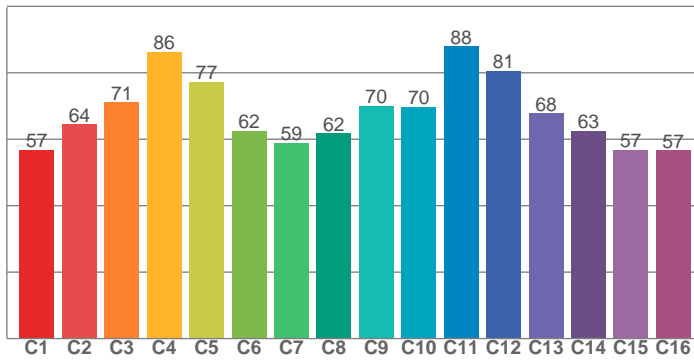

CRI R values, only R1-R8 are used to calculate final CRI value

R1	R2	R3	R4	R5	R6	R7	R8	R9	R10	R11	R12	R13	R14	R15
50,0	84,6	68,1	36,5	52,4	80,7	62,6	9,1	-93,7	70,2	22,5	76,7	58,4	78,9	33,9

TM30 C values, 16 binned values out of total of 99 C values

C1	C2	C3	C4	C5	C6	C7	C8	C9	C10	C11	C12	C13	C14	C15	C16
56,8	64,5	71,1	86,3	77,2	62,5	58,8	61,7	70,0	69,7	87,9	80,5	67,8	62,6	56,9	56,7

CQS Q values

Q1	Q2	Q3	Q4	Q5	Q6	Q7	Q8	Q9	Q10	Q11	Q12	Q13	Q14	Q15
79,3	88,5	91,1	79,5	67,1	69,3	94,8	79,1	78,2	96,3	85,1	76,2	74,9	84,5	85,5

CQS: 80,2

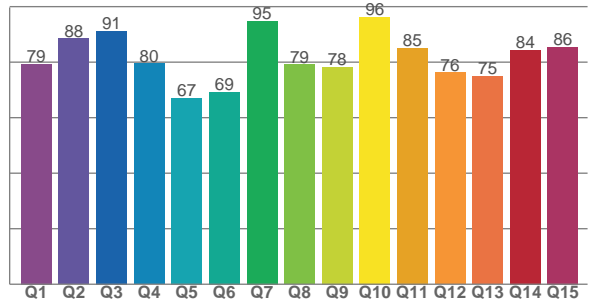

COLOR PARAMETERS

Color temperature	Color rendering index	Red component	Color fidelity	Color gamut	Color quality scale	Television lighting index	Color coordinate cie 1931	Color coordinate cie 1931	Color deviation from black body
CCT	CRI	CRI R9	TM30 Rf	TM30 Rg	CQS	TLCI	x	y	Δuv
4048 K	55,5	-93,7	69,3	126,6	80,2	46	0,366	0,328	-0,0205

TM30 DETAILS

Rf 69,3
Fidelity index Rf

Rg 126,6
Gammut index

Hue Bin	R _f	Graphic shifts (%)	
		Chroma	Hue
1	57	22%	-3%
2	64	14%	-10%
3	71	10%	-7%
4	86	5%	1%
5	77	11%	9%
6	62	20%	12%
7	59	25%	2%
8	62	20%	-6%
9	70	13%	-15%
10	70	4%	-16%
11	88	-1%	-1%
12	81	2%	9%
13	68	4%	22%
14	63	9%	26%
15	57	21%	20%
16	57	25%	5%

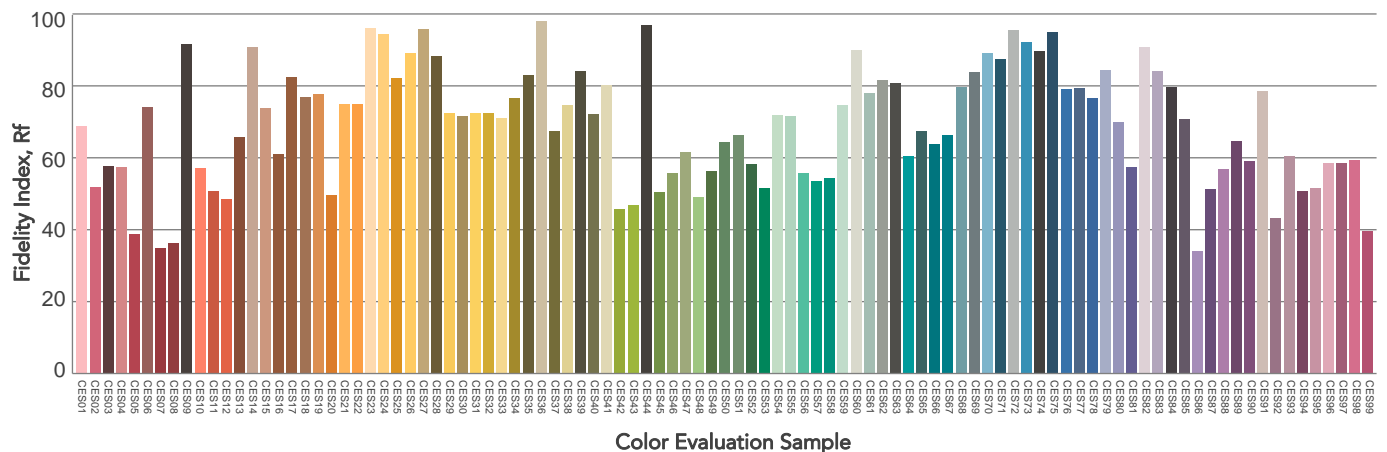
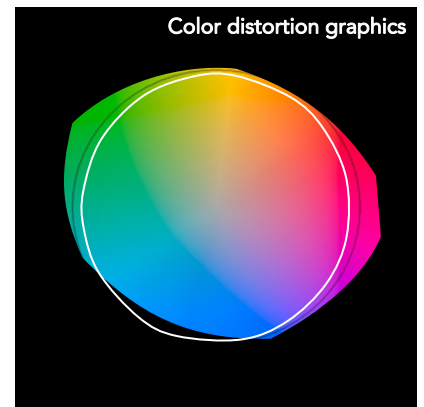
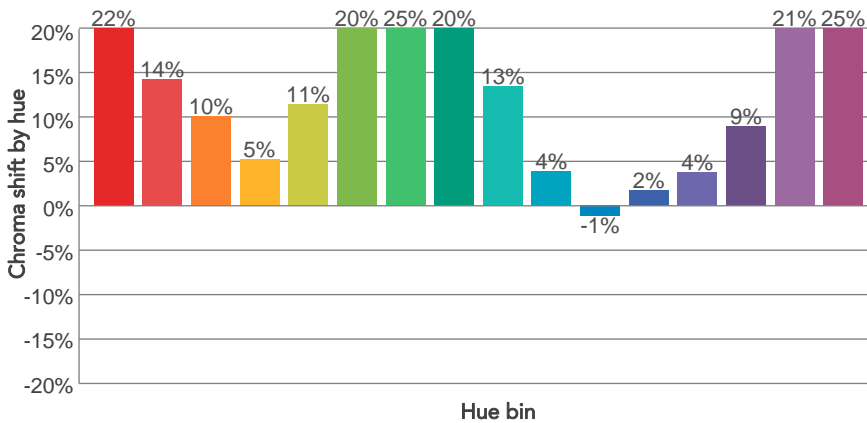
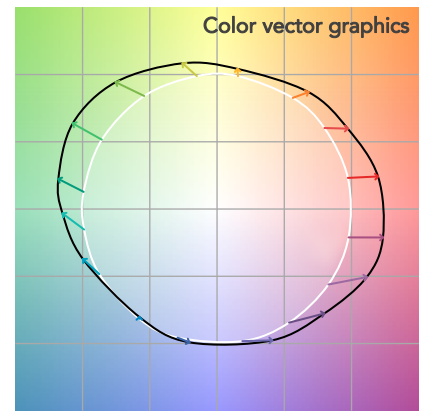
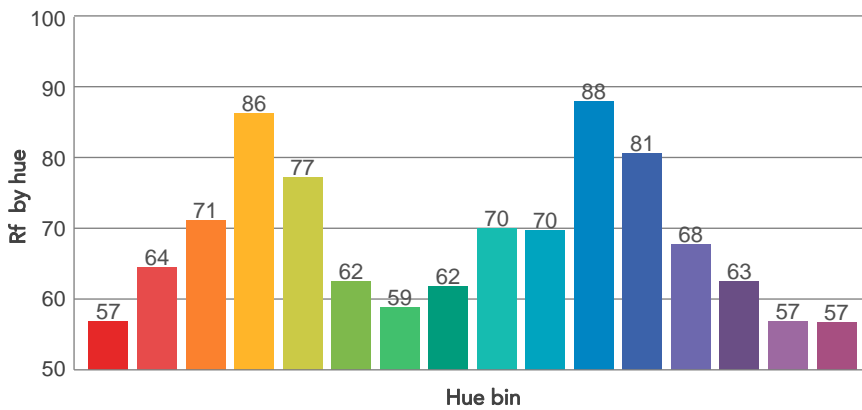
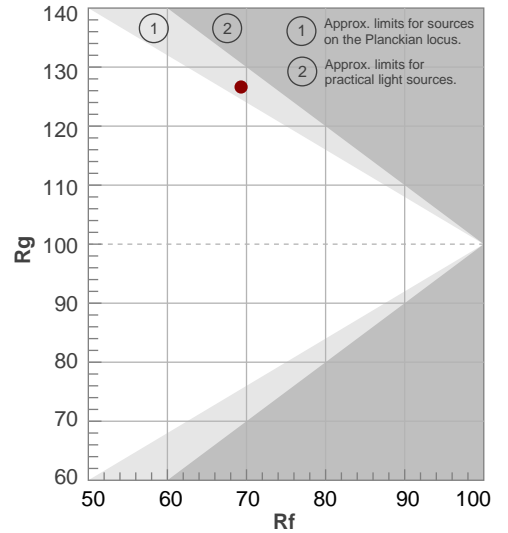

BEAM DETAILS



Beam angle 50%	Field angle 10%	Cut off angle 2,5%	Intensity ratio in 120° cone	Intensity ratio in 90° cone
4,2°	6,5°	7,3°	100,0%	100,0%

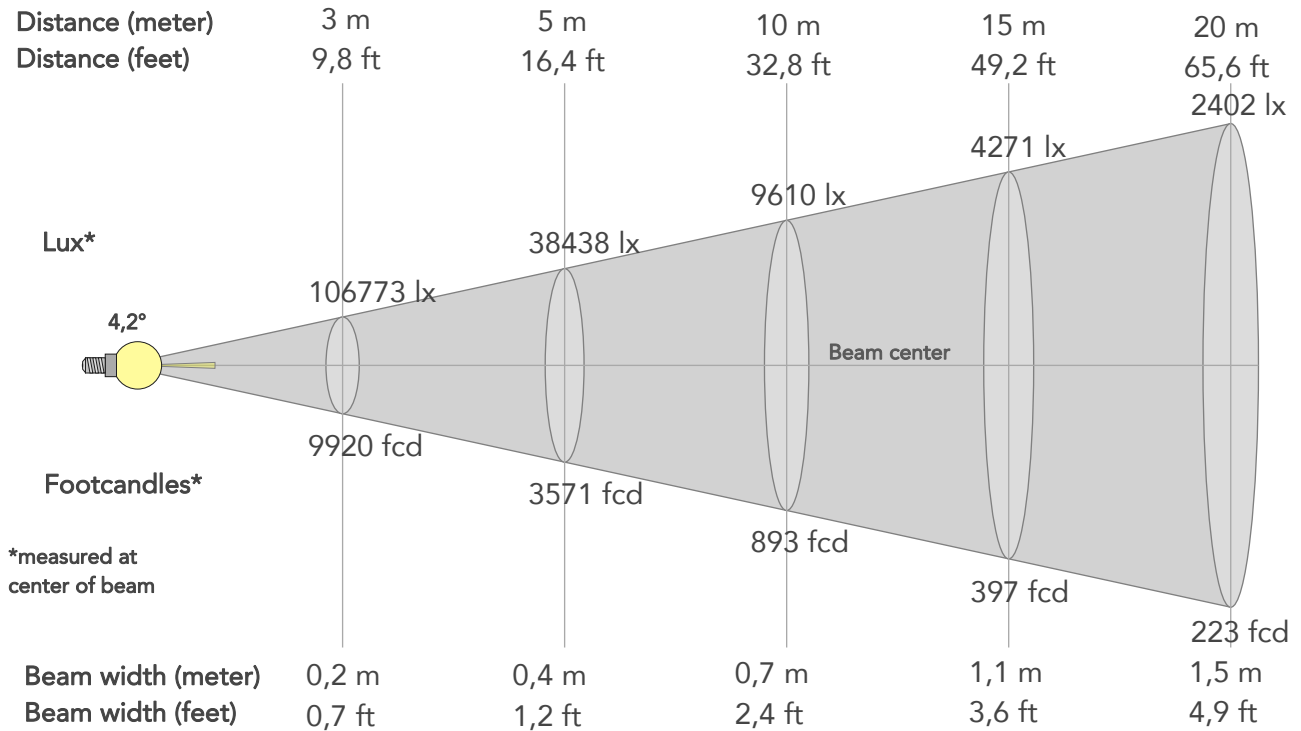

BEAM INTENSITIES AND WIDTHS

Distance	1m	2m	3m	4m	5m	7,5m	10m	15m	20m	25m	30m	40m	50m
Distance	3,3ft	6,6ft	9,8ft	13,1ft	16,4ft	24,6ft	32,8ft	49,2ft	65,6ft	82ft	98,4ft	131,2ft	164ft
Lux	960954lx	240239lx	106773lx	60060lx	38438lx	17084lx	9610lx	4271lx	2402lx	1538lx	1068lx	601lx	384lx
Footcand.	89276fcd	22319fcd	9920fcd	5580fcd	3571fcd	1587fcd	893fcd	397fcd	223fcd	143fcd	99fcd	56fcd	36fcd
Beam wid.	0,1m	0,1m	0,2m	0,3m	0,4m	0,6m	0,7m	1,1m	1,5m	1,9m	2,2m	3m	3,7m
Beam wid.	0,2ft	0,5ft	0,7ft	1ft	1,2ft	1,8ft	2,4ft	3,6ft	4,9ft	6,1ft	7,3ft	9,7ft	12,1ft

LINEAR DISTRIBUTION DIAGRAM

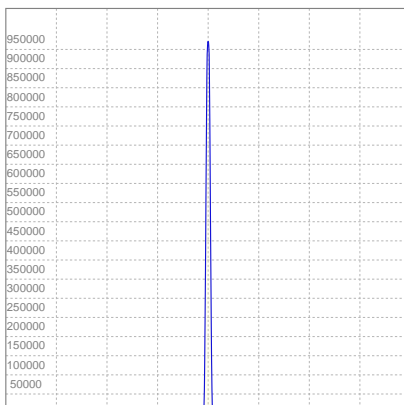

ELECTRICAL SPECIFICATIONS

Input voltage	Input current	Input power	Effeciency
222V	2,10A	437,7W	11lm/W

ISO CANDELA DIAGRAM

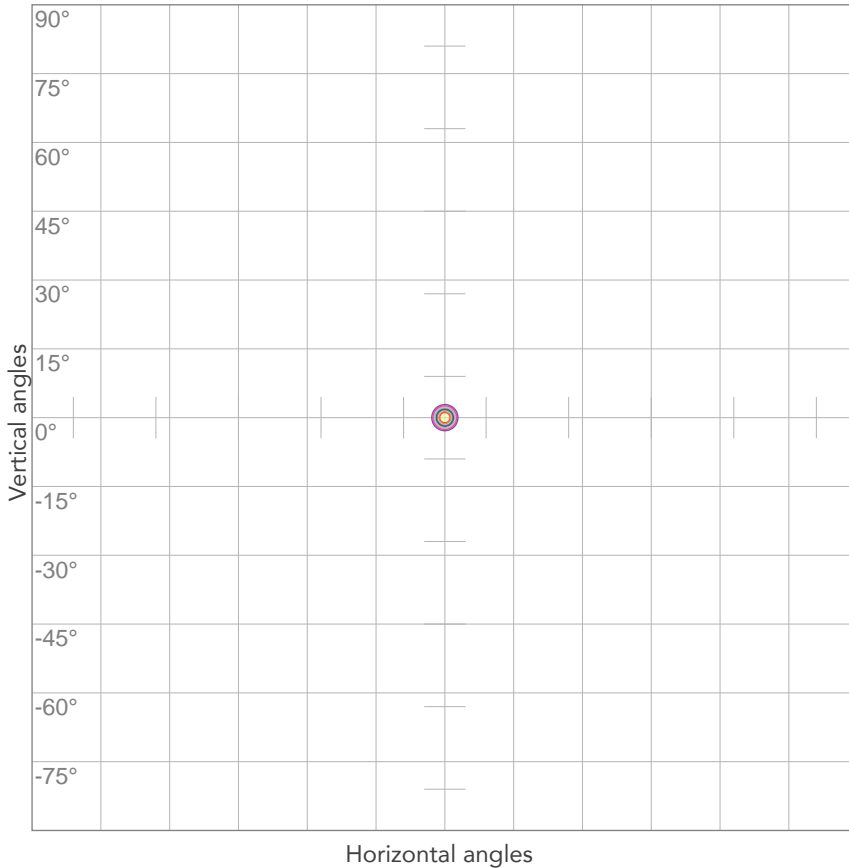

10%	96095 cd
20%	192191 cd
30%	288286 cd
40%	384382 cd
50%	480477 cd
60%	576572 cd
70%	672668 cd
80%	768763 cd

Conditions:
 Number of c-planes: 2
 Candela at center: 960954 cd

ISO LUX DIAGRAM

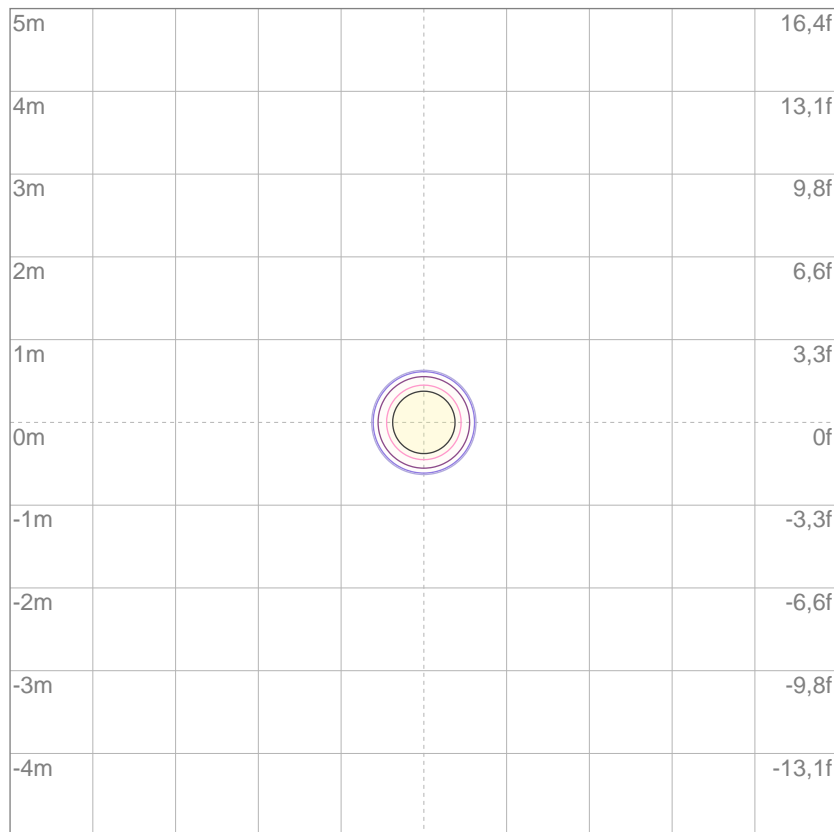

3%	288 lx
5%	480 lx
10%	961 lx
30%	2883 lx
50%	4805 lx

Conditions:
 Number of c-planes: 2
 Lux at center: 9610 lx

Lux distribution on a surface when lamp is mounted at 10 meters from the surface.

Mounting height: 10 meters (33 feet)



Total lumen output:

8866 lm

Peak candela output:

25692 cd

Light quality:

CRI: 55,8

Color temperature:

5597 K

PRODUCT NAME:

ASTRAWASH19PIX

MEASUREMENT CONDITIONS:

Beam angle:

Max Zoom

Target:

5600K

Operator:

Paolo Carvone

Date and time:

15/02/2021 12:17:14

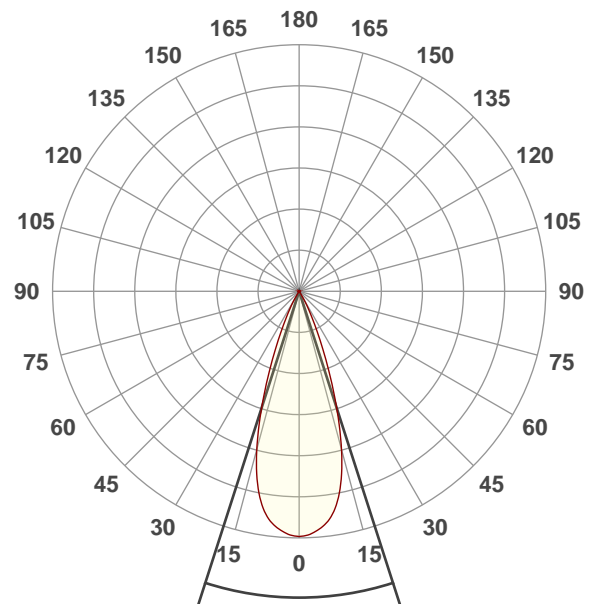

Beam angle 50%: 35,7°

Field angle 10%: 53,9°

Cut off angle 2.5%: 62,2°

Spectra

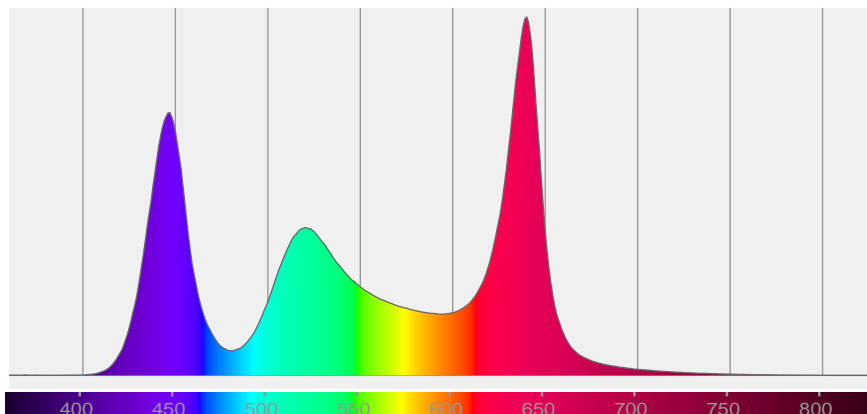

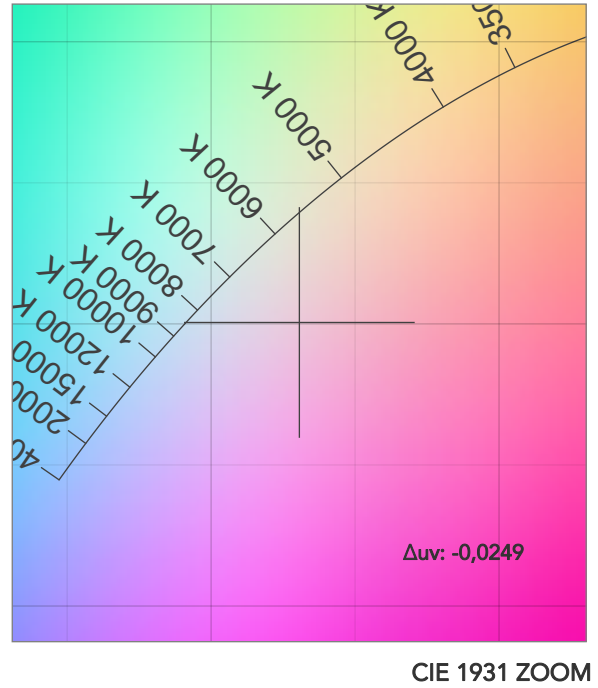
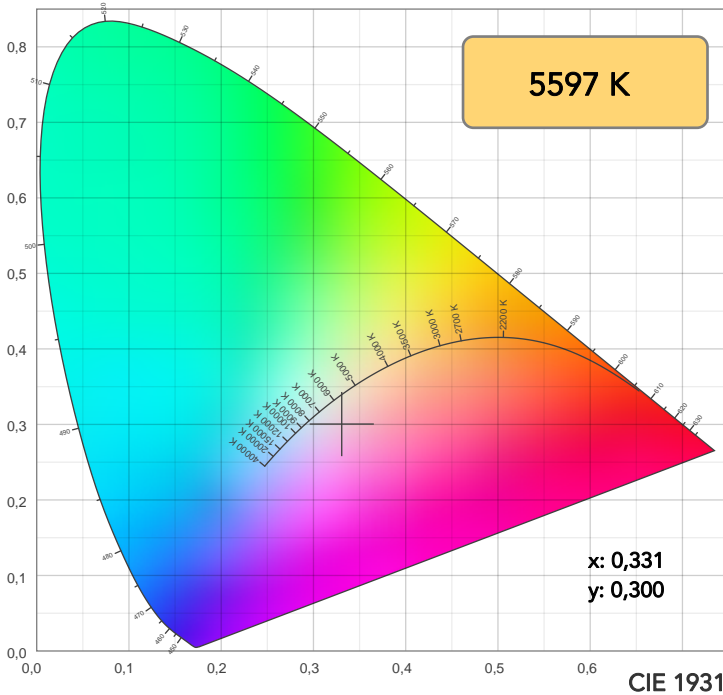

TM30: 68,9

CRI: 55,8 (R1-R8)

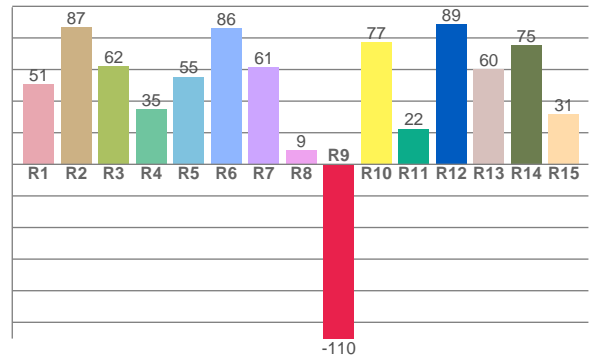
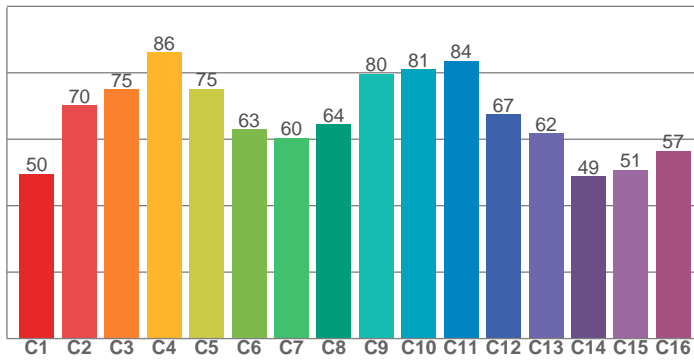

CRI R values, only R1-R8 are used to calculate final CRI value

R1	R2	R3	R4	R5	R6	R7	R8	R9	R10	R11	R12	R13	R14	R15
50,7	86,9	61,9	35,0	55,4	86,2	61,4	9,0	-110,3	77,5	22,5	88,8	60,4	75,5	31,5

TM30 C values, 16 binned values out of total of 99 C values

C1	C2	C3	C4	C5	C6	C7	C8	C9	C10	C11	C12	C13	C14	C15	C16
49,5	70,2	75,1	86,1	75,2	63,0	60,4	64,4	79,7	81,0	83,5	67,5	61,8	48,9	50,9	56,5

CQS Q values

Q1	Q2	Q3	Q4	Q5	Q6	Q7	Q8	Q9	Q10	Q11	Q12	Q13	Q14	Q15
77,8	85,8	82,6	89,4	73,9	76,6	95,2	75,3	72,0	90,4	91,7	82,1	79,7	84,0	83,9

CQS: 81,4

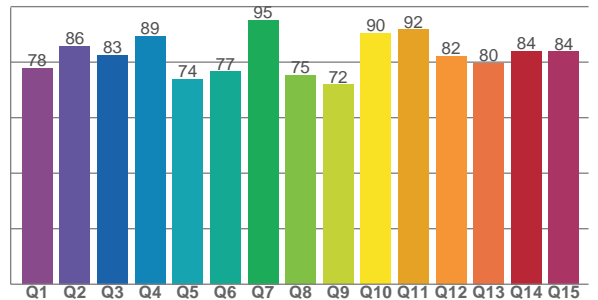

COLOR PARAMETERS

Color temperature	Color rendering index	Red component	Color fidelity	Color gamut	Color quality scale	Television lighting index	Color coordinate cie 1931	Color coordinate cie 1931	Color deviation from black body
CCT	CRI	CRI R9	TM30 Rf	TM30 Rg	CQS	TLCI	x	y	Δuv
5597 K	55,8	-110,3	68,9	127,2	81,4	50	0,331	0,300	-0,0249

TM30 DETAILS

Rf 68,9
Fidelity index Rf

Rg 127,2
Gammut index

Hue Bin	R _f	Graphic shifts (%)	
		Chroma	Hue
1	50	23%	-2%
2	70	14%	-8%
3	75	11%	-5%
4	86	5%	5%
5	75	11%	10%
6	63	20%	12%
7	60	23%	4%
8	64	19%	-5%
9	80	11%	-12%
10	81	2%	-9%
11	84	-1%	8%
12	67	-2%	20%
13	62	4%	31%
14	49	13%	27%
15	51	29%	30%
16	57	23%	4%

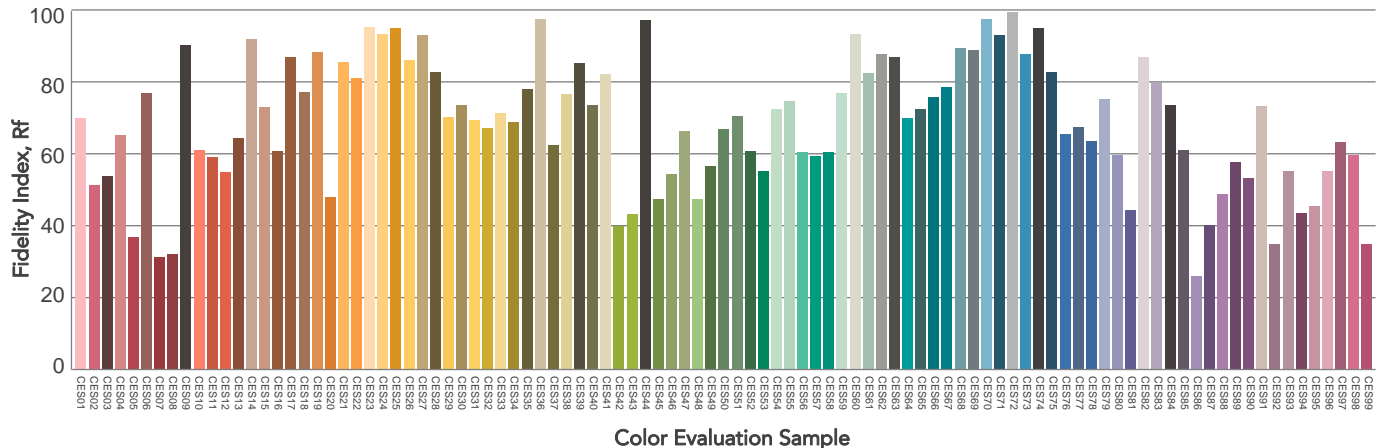
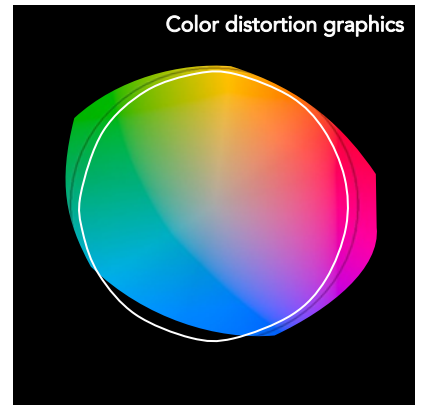
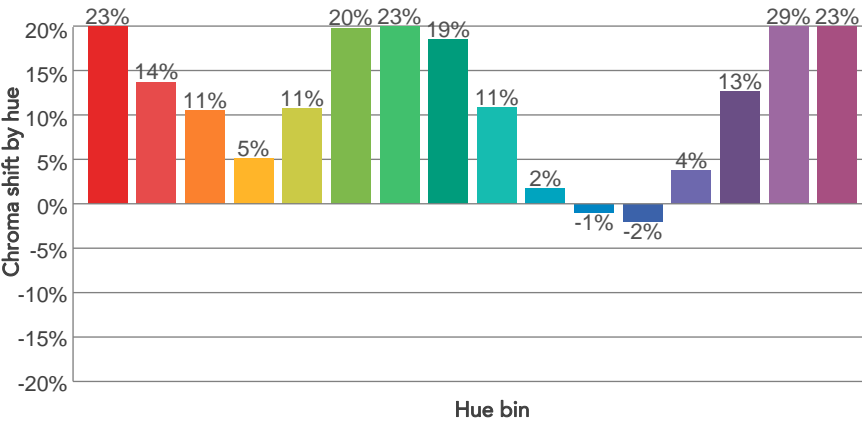
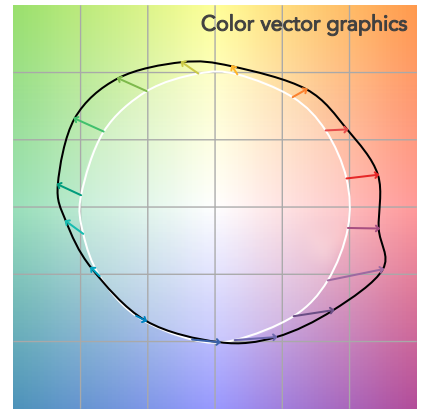
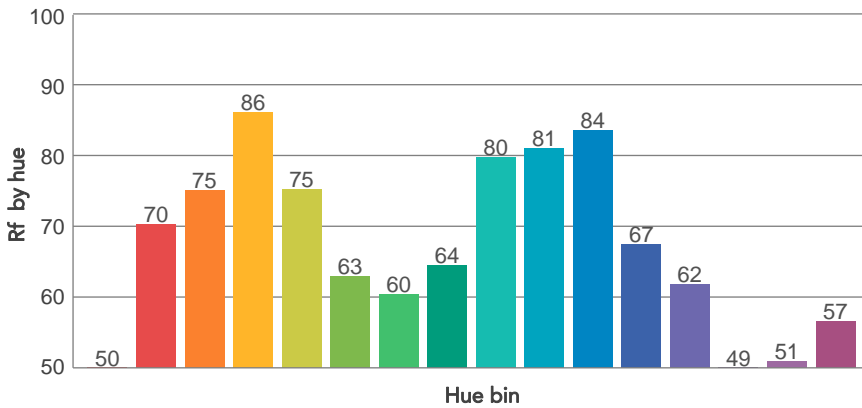
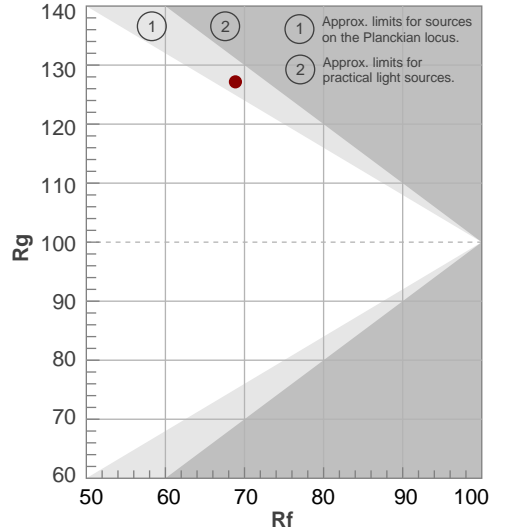

BEAM DETAILS



Beam angle 50%	Field angle 10%	Cut off angle 2,5%	Intensity ratio in 120° cone	Intensity ratio in 90° cone
35,7°	53,9°	62,2°	100,0%	100,0%

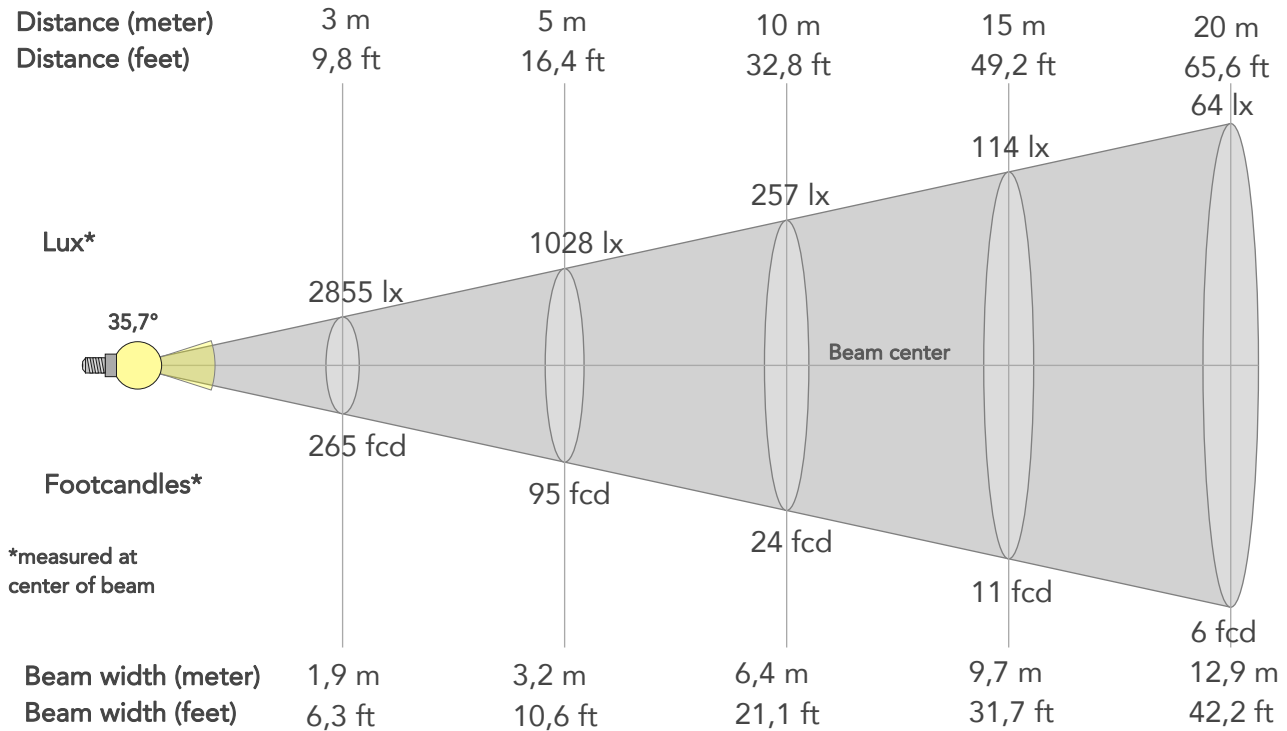

BEAM INTENSITIES AND WIDTHS

Distance	1m	2m	3m	4m	5m	7,5m	10m	15m	20m	25m	30m	40m	50m
Distance	3,3ft	6,6ft	9,8ft	13,1ft	16,4ft	24,6ft	32,8ft	49,2ft	65,6ft	82ft	98,4ft	131,2ft	164ft
Lux	25692lx	6423lx	2855lx	1606lx	1028lx	457lx	257lx	114lx	64lx	41lx	29lx	16lx	10lx
Footcand.	2387fcd	597fcd	265fcd	149fcd	95fcd	42fcd	24fcd	11fcd	6fcd	4fcd	3fcd	1fcd	1fcd
Beam wid.	0,6m	1,3m	1,9m	2,6m	3,2m	4,8m	6,4m	9,7m	12,9m	16,1m	19,3m	25,7m	32,2m
Beam wid.	2,1ft	4,2ft	6,3ft	8,4ft	10,6ft	15,8ft	21,1ft	31,7ft	42,2ft	52,8ft	63,3ft	84,4ft	105,6ft

LINEAR DISTRIBUTION DIAGRAM

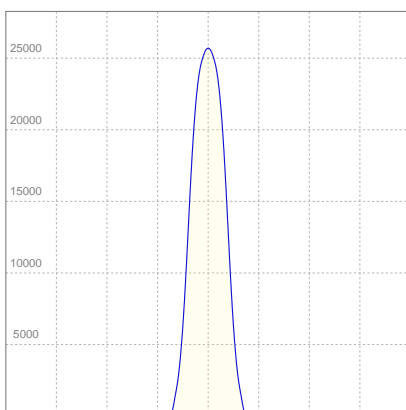

ELECTRICAL SPECIFICATIONS

Input voltage	Input current	Input power	Effeciency
225V	2,15A	456,7W	19lm/W

ISO CANDELA DIAGRAM

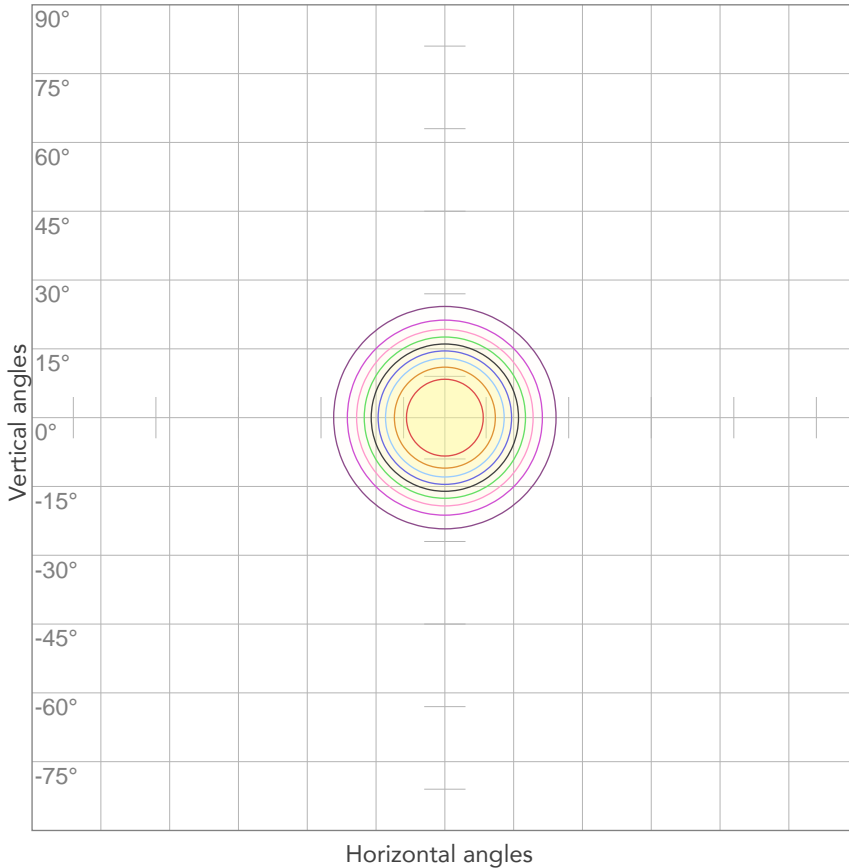

10%	2569 cd
20%	5138 cd
30%	7708 cd
40%	10277 cd
50%	12846 cd
60%	15415 cd
70%	17984 cd
80%	20554 cd

Conditions:

Number of c-planes: 2

Candela at center: 25692 cd

ISO LUX DIAGRAM

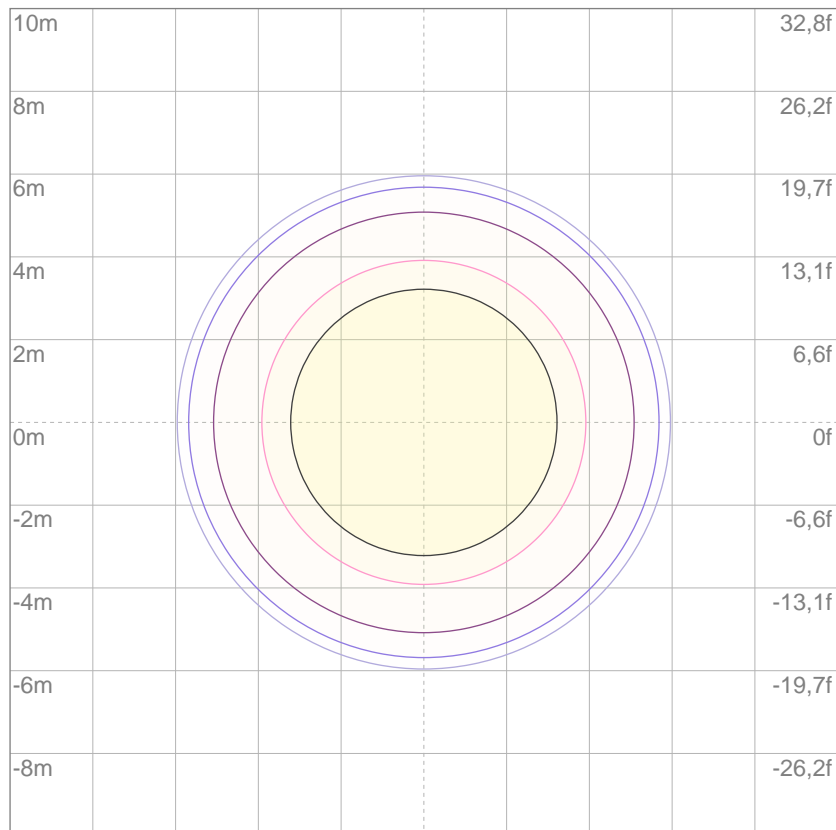

Mounting height: 10 meters (33 feet)

3%	7,71 lx
5%	12,8 lx
10%	25,7 lx
30%	77,1 lx
50%	128 lx

Conditions:

Number of c-planes: 2

Lux at center: 257 lx

Lux distribution on a surface when lamp is mounted at 10 meters from the surface.



Total lumen output:

7517 lm

Peak candela output:

92480 cd

Light quality:

CRI: 55,1

Color temperature:

5603 K

PRODUCT NAME:

ASTRAWASH19PIX

MEASURAMENT CONDITIONS:

Beam angle:

Med Zoom

Target:

5600K

Operator:

Paolo Carvone

Date and time:

15/02/2021 12:19:20

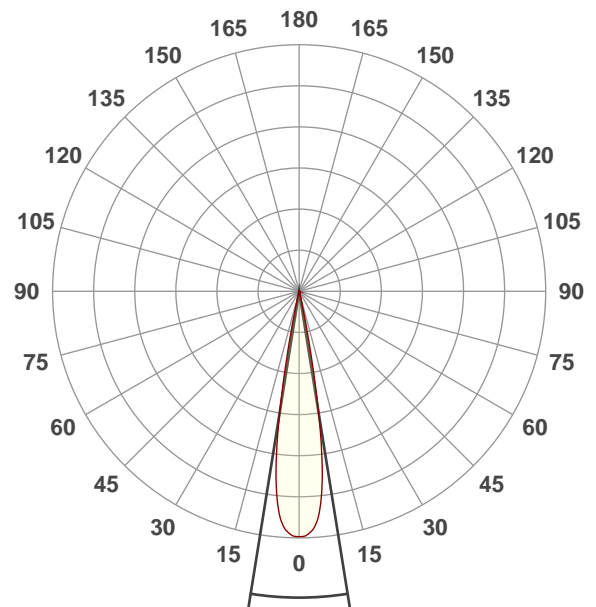

Beam angle 50%: 18,2°

Field angle 10%: 24,1°

Cut off angle 2.5%: 26,5°

Spectra

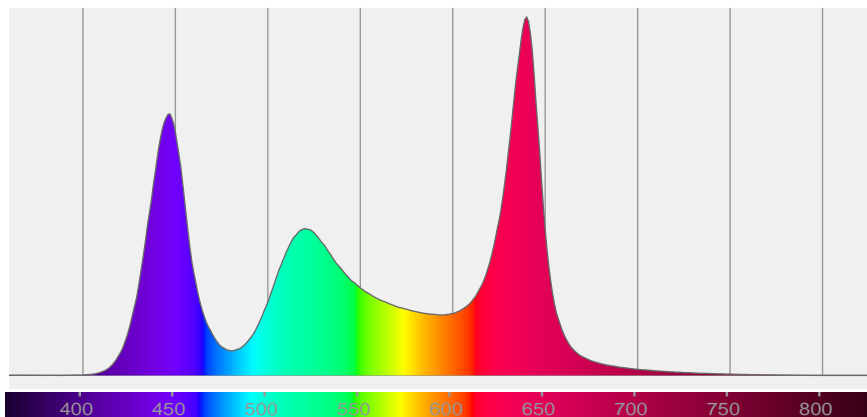

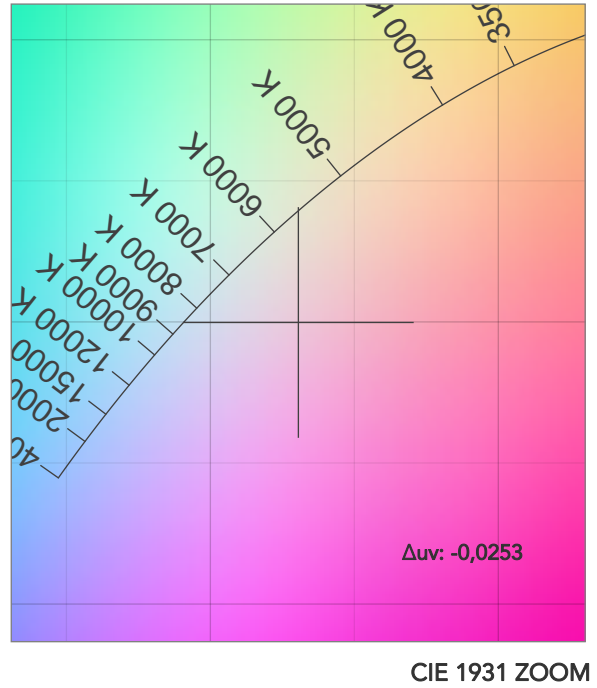
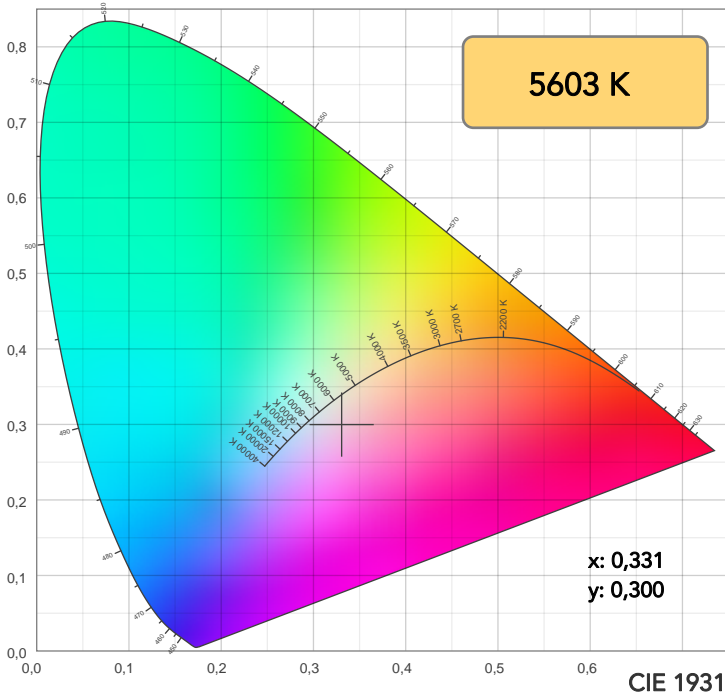

TM30: 68,6

CRI: 55,1 (R1-R8)

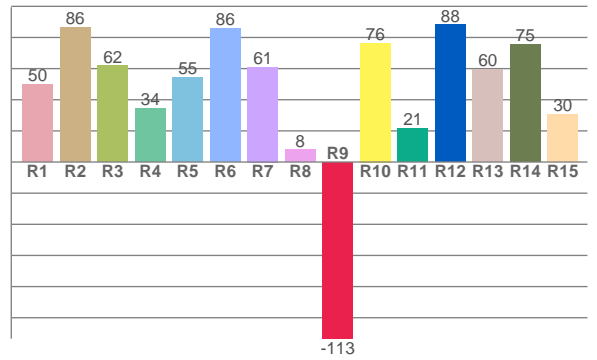
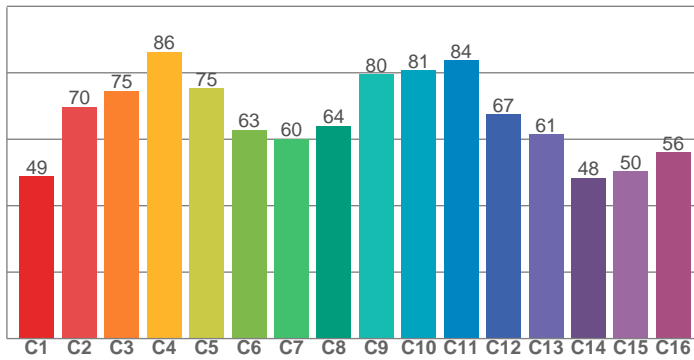

CRI R values, only R1-R8 are used to calculate final CRI value

R1	R2	R3	R4	R5	R6	R7	R8	R9	R10	R11	R12	R13	R14	R15
49,8	86,5	61,7	34,2	54,6	85,6	61,0	7,7	-113,4	76,5	21,5	88,0	59,5	75,4	30,3

TM30 C values, 16 binned values out of total of 99 C values

C1	C2	C3	C4	C5	C6	C7	C8	C9	C10	C11	C12	C13	C14	C15	C16
48,8	69,8	74,5	86,2	75,3	62,8	60,1	64,0	79,5	80,7	83,7	67,4	61,5	48,4	50,3	56,1

CQS Q values

Q1	Q2	Q3	Q4	Q5	Q6	Q7	Q8	Q9	Q10	Q11	Q12	Q13	Q14	Q15
77,4	85,7	82,7	89,0	73,7	76,6	95,0	75,0	71,8	90,6	91,3	81,7	79,4	83,8	83,5

CQS: 81,2

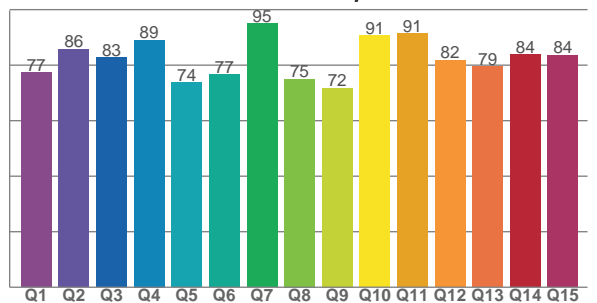

COLOR PARAMETERS

Color temperature	Color rendering index	Red component	Color fidelity	Color gamut	Color quality scale	Television lighting index	Color coordinate cie 1931	Color coordinate cie 1931	Color deviation from black body
CCT	CRI	CRI R9	TM30 Rf	TM30 Rg	CQS	TLCI	x	y	Δuv
5603 K	55,1	-113,4	68,6	127,4	81,2	50	0,331	0,300	-0,0253

TM30 DETAILS

Rf 68,6
Fidelity index Rf

Rg 127,4
Gammut index

Hue Bin	R _f	Graphic shifts (%)	
		Chroma	Hue
1	49	24%	-2%
2	70	14%	-8%
3	75	11%	-6%
4	86	5%	5%
5	75	11%	10%
6	63	20%	13%
7	60	24%	4%
8	64	19%	-4%
9	80	11%	-12%
10	81	2%	-9%
11	84	-1%	8%
12	67	-2%	20%
13	61	4%	31%
14	48	13%	27%
15	50	30%	30%
16	56	23%	4%

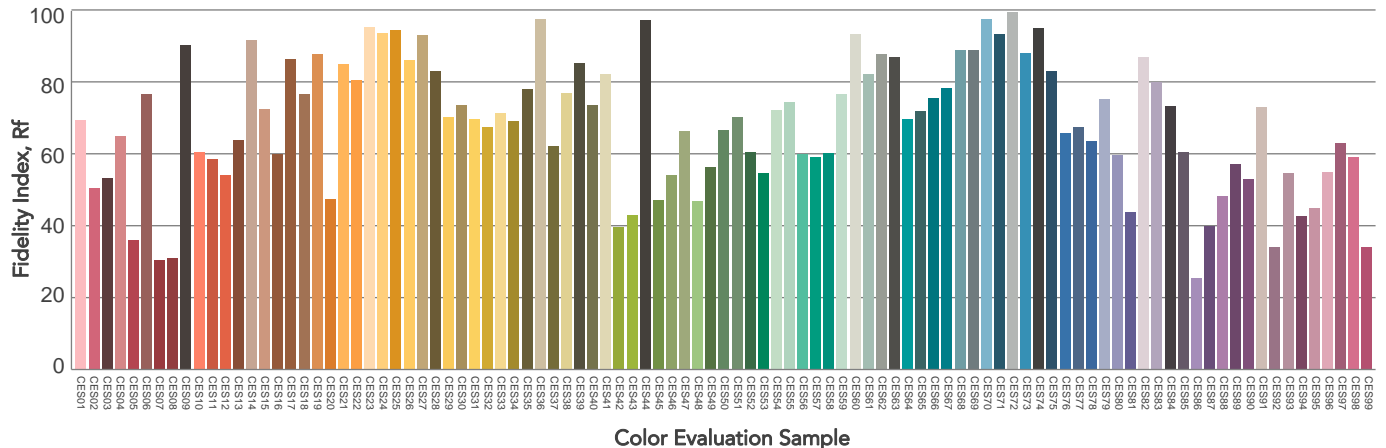
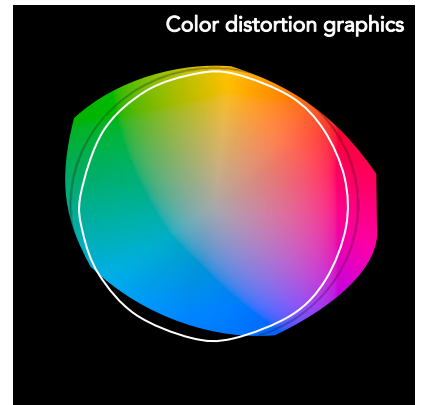
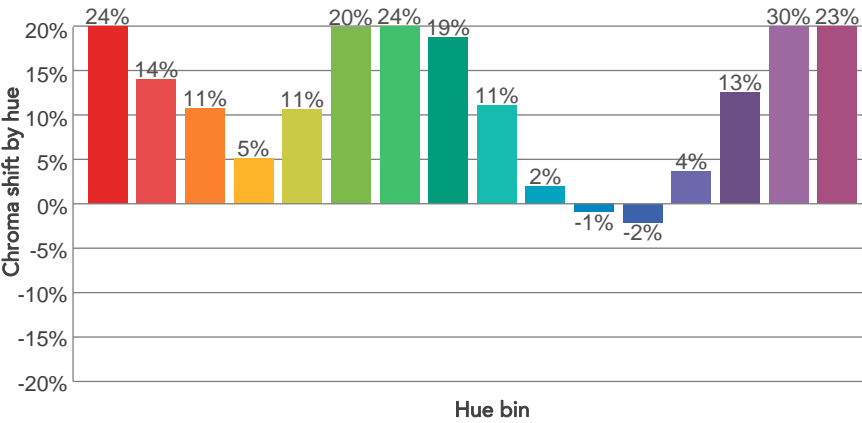
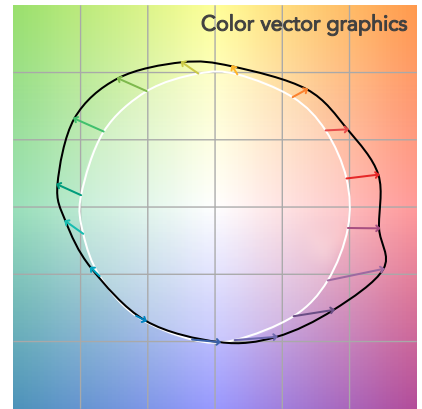
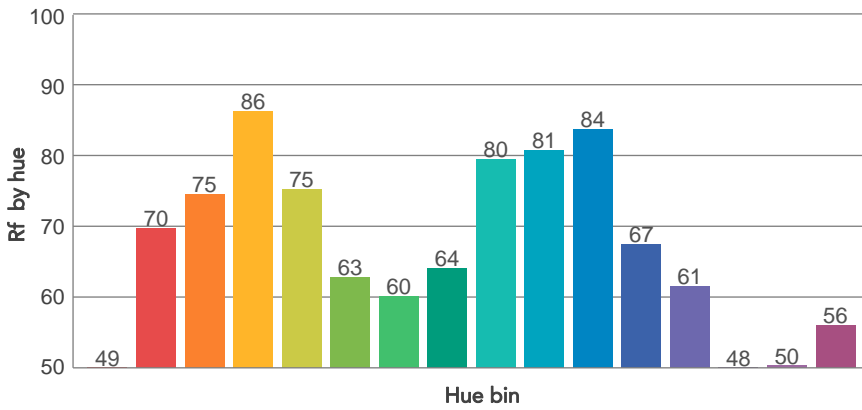
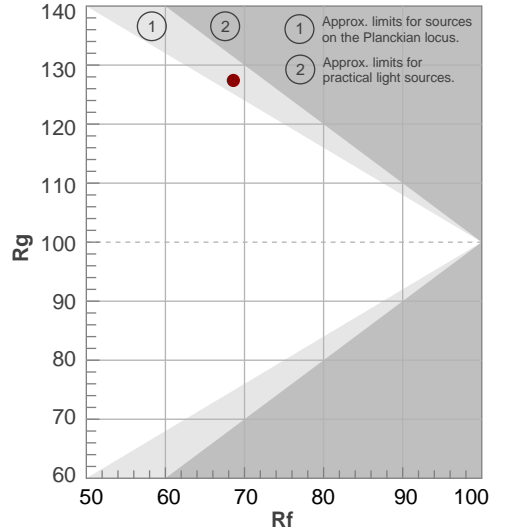

BEAM DETAILS



Beam angle 50%	Field angle 10%	Cut off angle 2,5%	Intensity ratio in 120° cone	Intensity ratio in 90° cone
18,2°	24,1°	26,5°	100,0%	100,0%

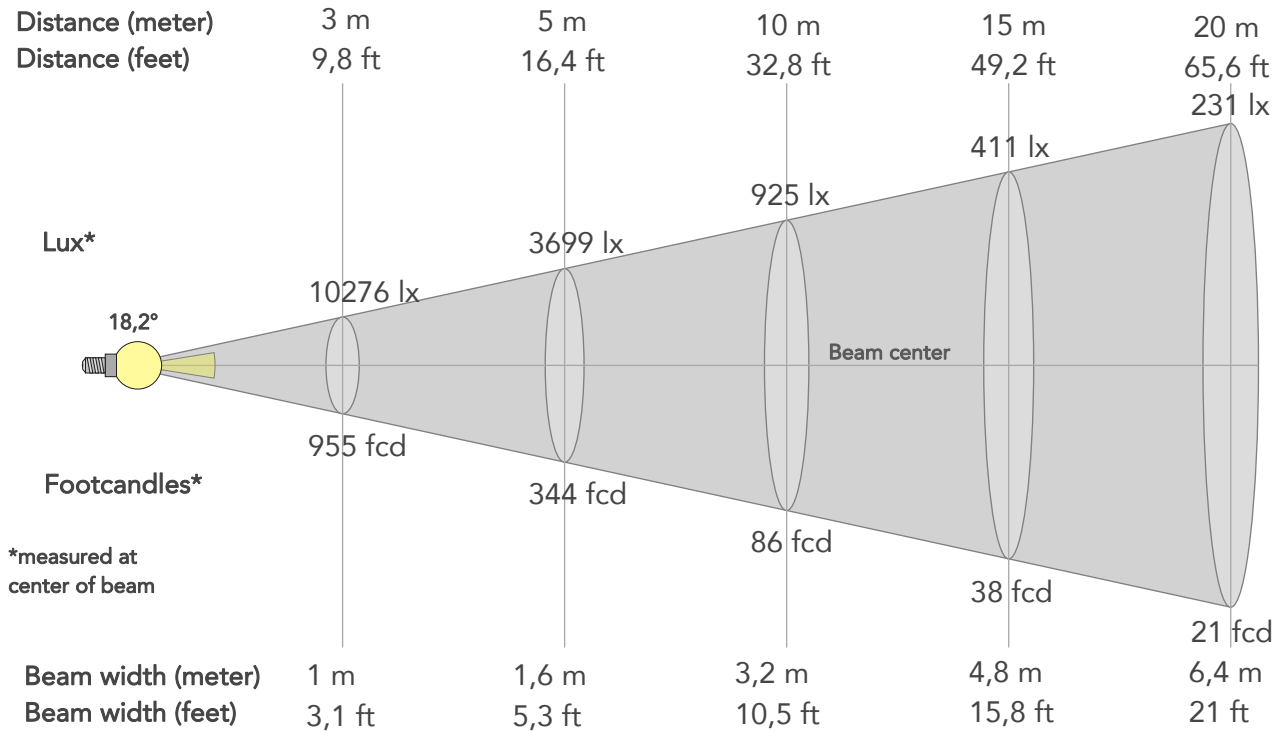

BEAM INTENSITIES AND WIDTHS

Distance	1m	2m	3m	4m	5m	7,5m	10m	15m	20m	25m	30m	40m	50m
Distance	3,3ft	6,6ft	9,8ft	13,1ft	16,4ft	24,6ft	32,8ft	49,2ft	65,6ft	82ft	98,4ft	131,2ft	164ft
Lux	92480lx	23120lx	10276lx	5780lx	3699lx	1644lx	925lx	411lx	231lx	148lx	103lx	58lx	37lx
Footcand.	8592fcd	2148fcd	955fcd	537fcd	344fcd	153fcd	86fcd	38fcd	21fcd	14fcd	10fcd	5fcd	3fcd
Beam wid.	0,3m	0,6m	1m	1,3m	1,6m	2,4m	3,2m	4,8m	6,4m	8m	9,6m	12,8m	16m
Beam wid.	1,1ft	2,1ft	3,1ft	4,2ft	5,3ft	7,9ft	10,5ft	15,8ft	21ft	26,3ft	31,5ft	42,1ft	52,6ft

LINEAR DISTRIBUTION DIAGRAM

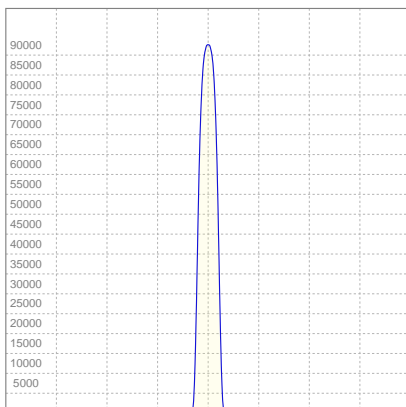

ELECTRICAL SPECIFICATIONS

Input voltage	Input current	Input power	Effeciency
224V	2,15A	456,1W	16lm/W

ISO CANDELA DIAGRAM

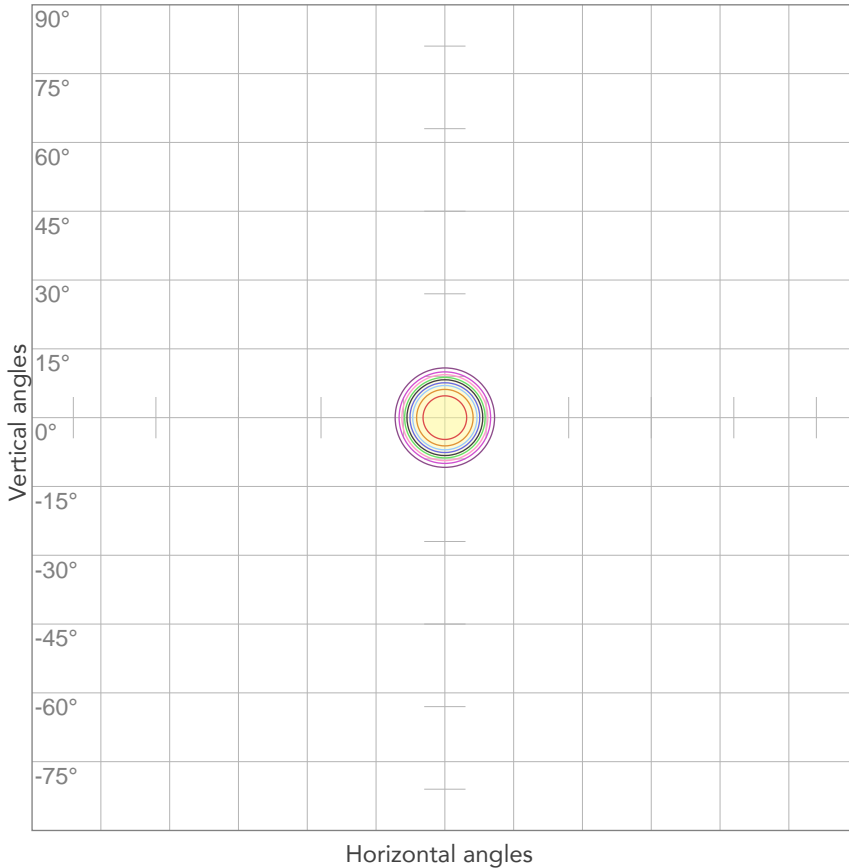

10%	9248 cd
20%	18496 cd
30%	27744 cd
40%	36992 cd
50%	46240 cd
60%	55488 cd
70%	64736 cd
80%	73984 cd

Conditions:

Number of c-planes: 2

Candela at center: 92480 cd

ISO LUX DIAGRAM

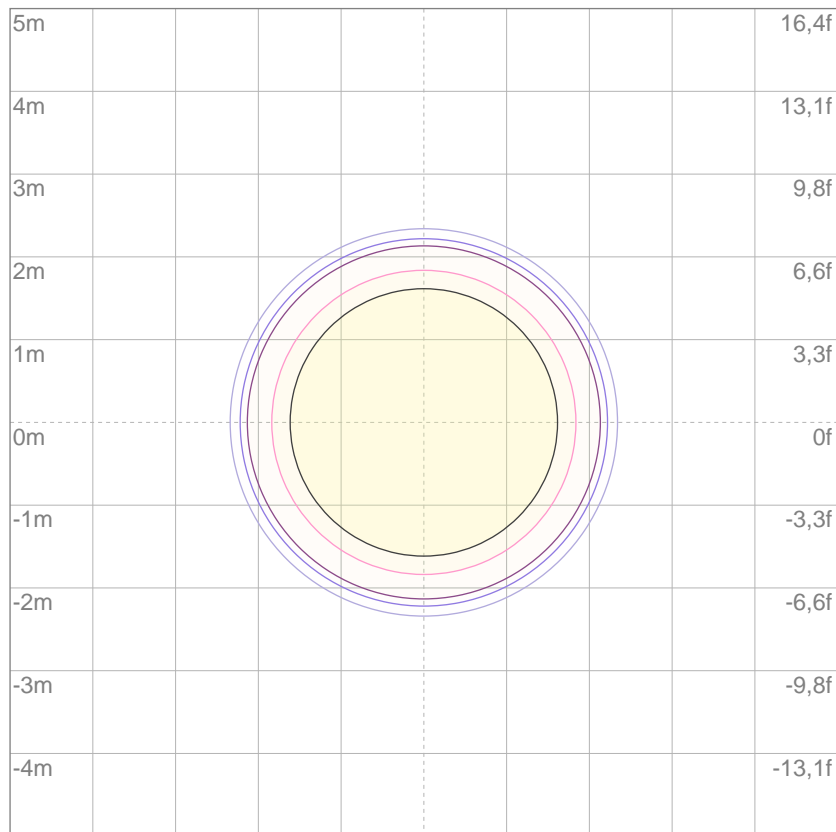

Mounting height: 10 meters (33 feet)

3%	27,7 lx
5%	46,2 lx
10%	92,5 lx
30%	277 lx
50%	462 lx

Conditions:

Number of c-planes: 2

Lux at center: 925 lx

Lux distribution on a surface when lamp is mounted at 10 meters from the surface.



Total lumen output:

4903 lm

Peak candela output:

991872 cd

Light quality:

CRI: 53,7

Color temperature:

5629 K

PRODUCT NAME:

ASTRAWASH19PIX

MEASUREMENT CONDITIONS:

Beam angle:

Min Zoom

Target:

5600K

Operator:

Paolo Carvone

Date and time:

15/02/2021 12:29:53

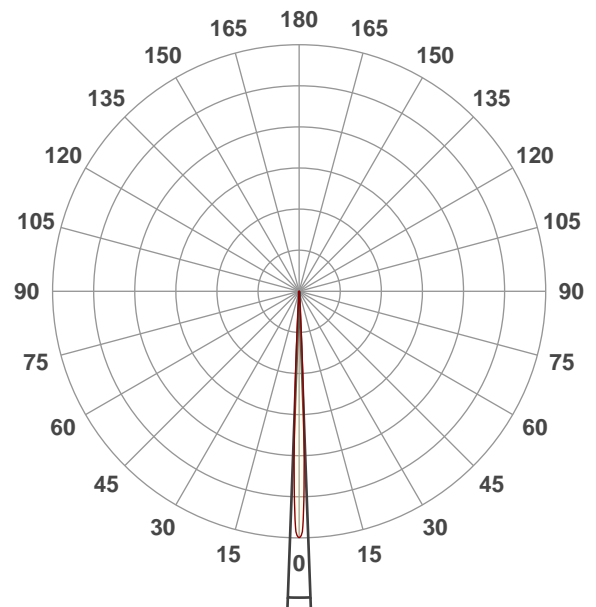

Spectra

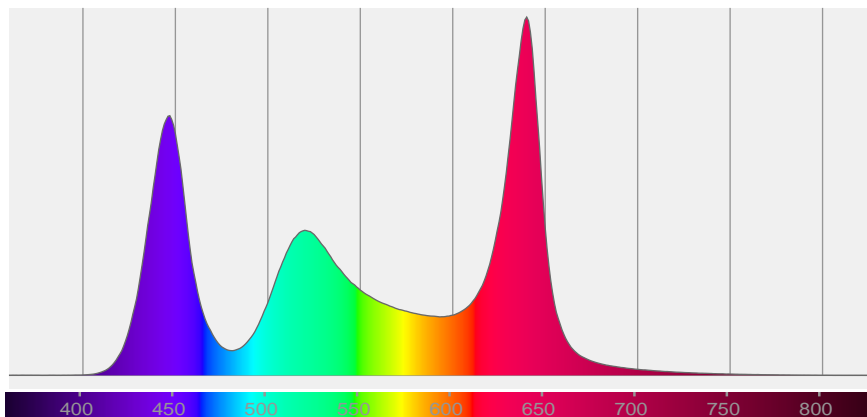

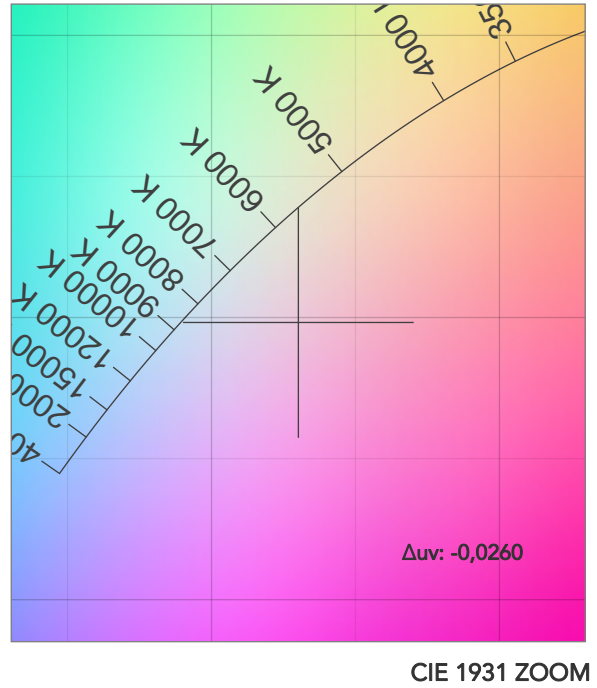
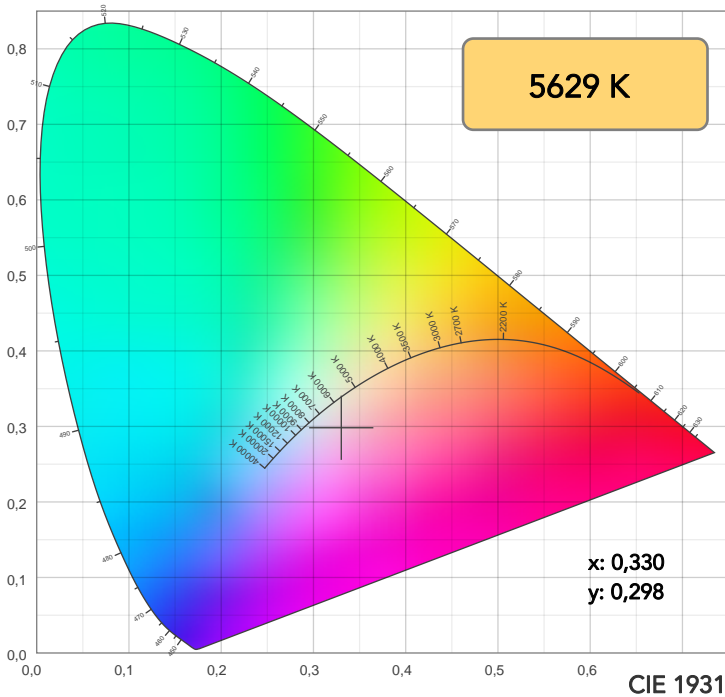

TM30: 68,0

CRI: 53,7 (R1-R8)

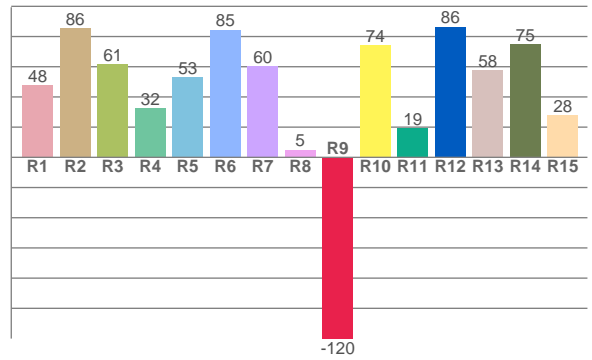
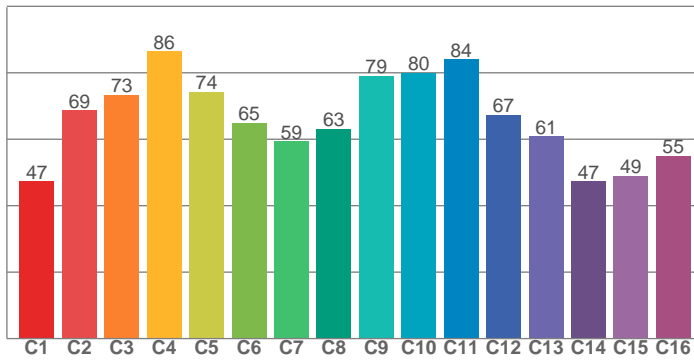

CRI R values, only R1-R8 are used to calculate final CRI value

R1	R2	R3	R4	R5	R6	R7	R8	R9	R10	R11	R12	R13	R14	R15
47,9	85,5	61,4	32,4	52,8	84,5	60,3	5,0	-120,0	74,4	19,2	86,4	57,8	75,1	27,9

TM30 C values, 16 binned values out of total of 99 C values

C1	C2	C3	C4	C5	C6	C7	C8	C9	C10	C11	C12	C13	C14	C15	C16
47,4	68,7	73,4	86,4	74,2	65,0	59,4	63,2	79,0	79,9	84,0	67,3	60,8	47,4	49,1	55,0

CQS Q values

Q1	Q2	Q3	Q4	Q5	Q6	Q7	Q8	Q9	Q10	Q11	Q12	Q13	Q14	Q15
76,5	85,5	83,1	88,2	73,2	76,7	94,4	74,1	71,3	91,0	90,5	80,8	78,8	83,2	82,8

CQS: 80,8

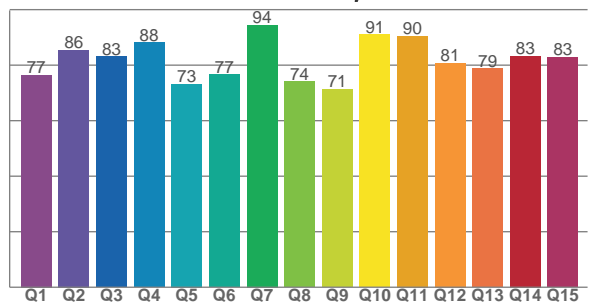

COLOR PARAMETERS

Color temperature	Color rendering index	Red component	Color fidelity	Color gamut	Color quality scale	Television lighting index	Color coordinate cie 1931	Color coordinate cie 1931	Color deviation from black body
CCT	CRI	CRI R9	TM30 Rf	TM30 Rg	CQS	TLCI	x	y	Δuv
5629 K	53,7	-120,0	68,0	128,0	80,8	48	0,330	0,298	-0,0260

TM30 DETAILS

Rf 68,0
Fidelity index Rf

Rg 128,0
Gammut index

Hue Bin	R _f	Graphic shifts (%)	
		Chroma	Hue
1	47	25%	-2%
2	69	14%	-9%
3	73	11%	-6%
4	86	5%	4%
5	74	10%	10%
6	65	20%	12%
7	59	24%	4%
8	63	19%	-4%
9	79	12%	-12%
10	80	2%	-9%
11	84	-1%	8%
12	67	-2%	21%
13	61	3%	32%
14	47	13%	28%
15	49	30%	31%
16	55	23%	5%

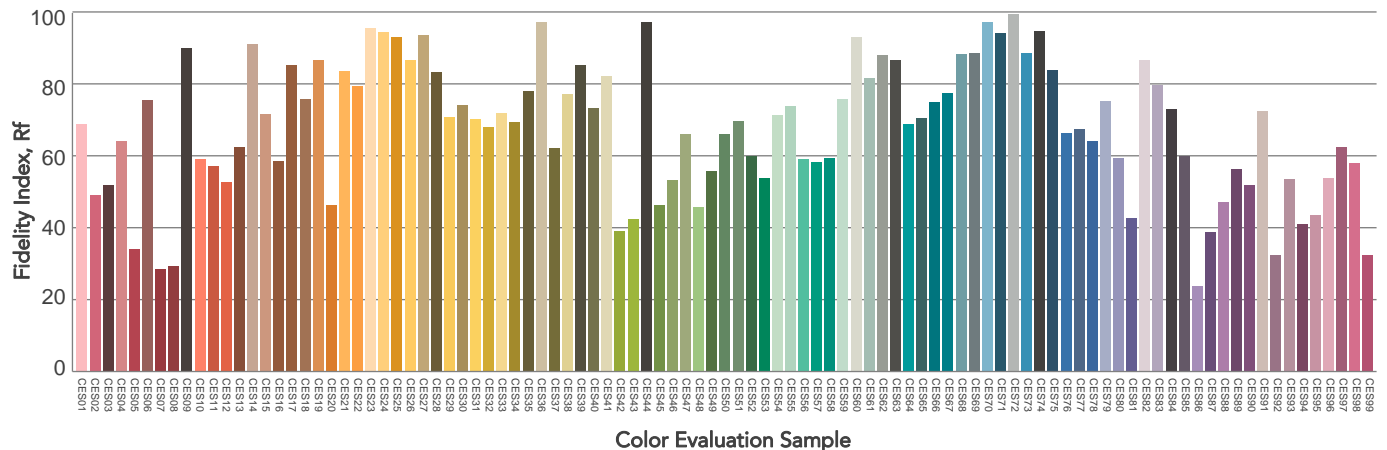
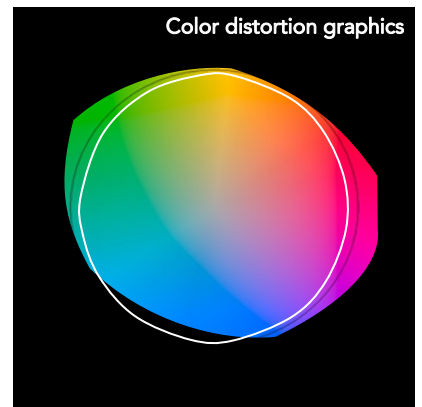
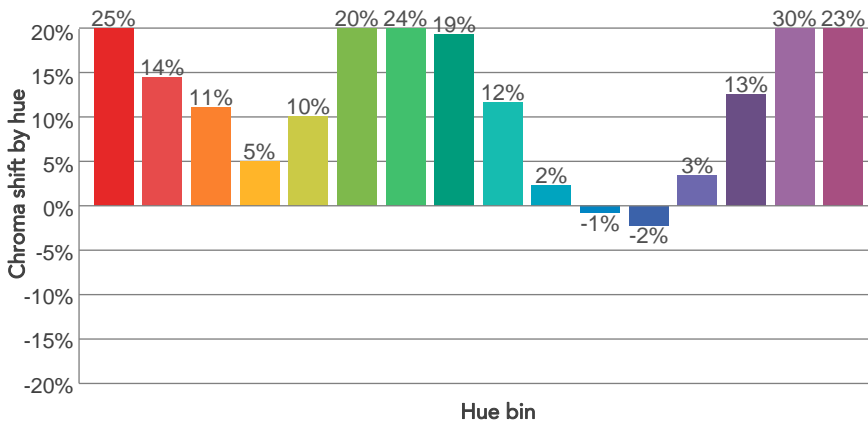
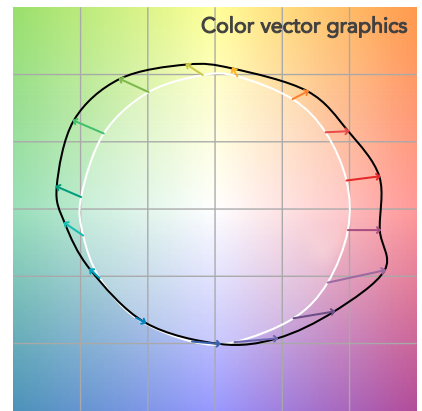
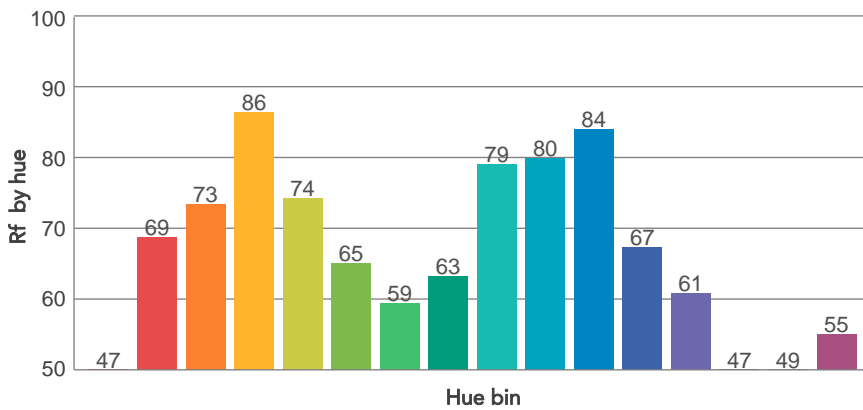
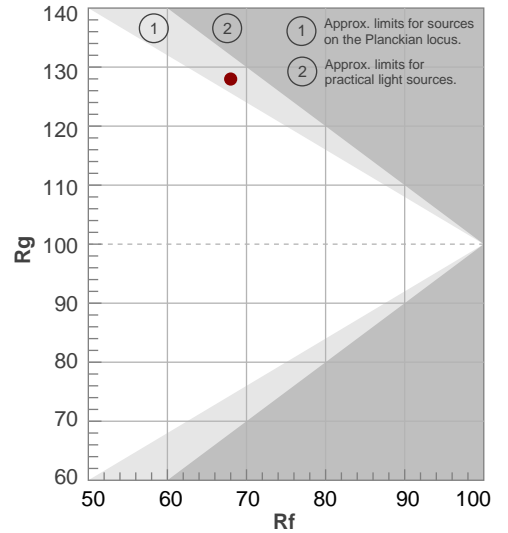

BEAM DETAILS



Beam angle 50%	Field angle 10%	Cut off angle 2,5%	Intensity ratio in 120° cone	Intensity ratio in 90° cone
4,2°	6,4°	7,2°	100,0%	100,0%

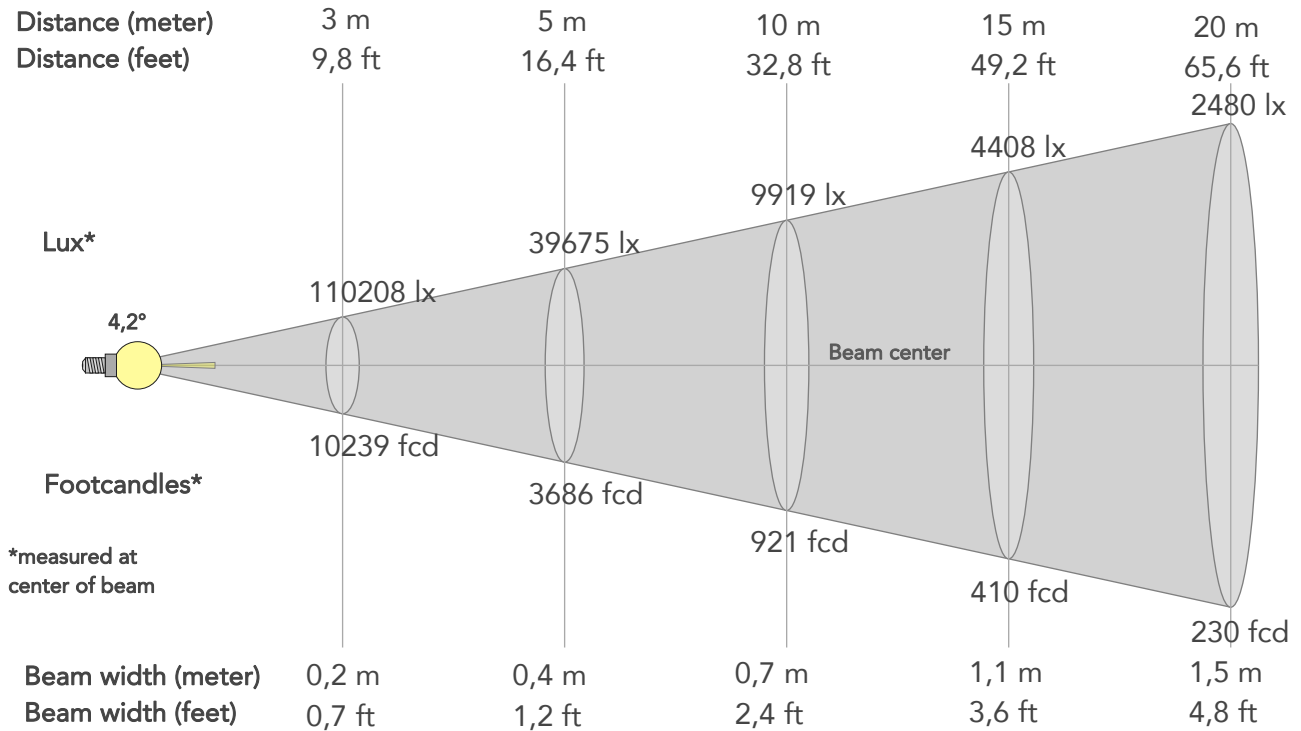

BEAM INTENSITIES AND WIDTHS

Distance	1m	2m	3m	4m	5m	7,5m	10m	15m	20m	25m	30m	40m	50m
Distance	3,3ft	6,6ft	9,8ft	13,1ft	16,4ft	24,6ft	32,8ft	49,2ft	65,6ft	82ft	98,4ft	131,2ft	164ft
Lux	991872lx	247968lx	110208lx	61992lx	39675lx	17633lx	9919lx	4408lx	2480lx	1587lx	1102lx	620lx	397lx
Footcand.	92148fcd	23037fcd	10239fcd	5759fcd	3686fcd	1638fcd	921fcd	410fcd	230fcd	147fcd	102fcd	58fcd	37fcd
Beam wid.	0,1m	0,1m	0,2m	0,3m	0,4m	0,6m	0,7m	1,1m	1,5m	1,8m	2,2m	3m	3,7m
Beam wid.	0,2ft	0,5ft	0,7ft	1ft	1,2ft	1,8ft	2,4ft	3,6ft	4,8ft	6,1ft	7,3ft	9,7ft	12,1ft

LINEAR DISTRIBUTION DIAGRAM

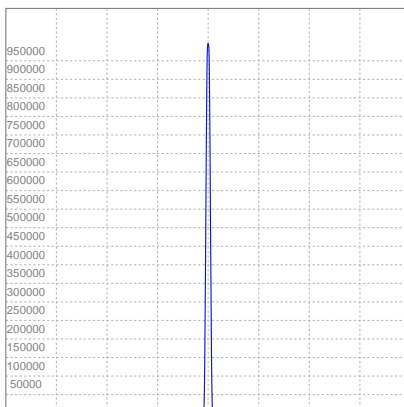

ELECTRICAL SPECIFICATIONS

Input voltage	Input current	Input power	Effeciency
221V	2,18A	456,3W	11lm/W

ISO CANDELA DIAGRAM

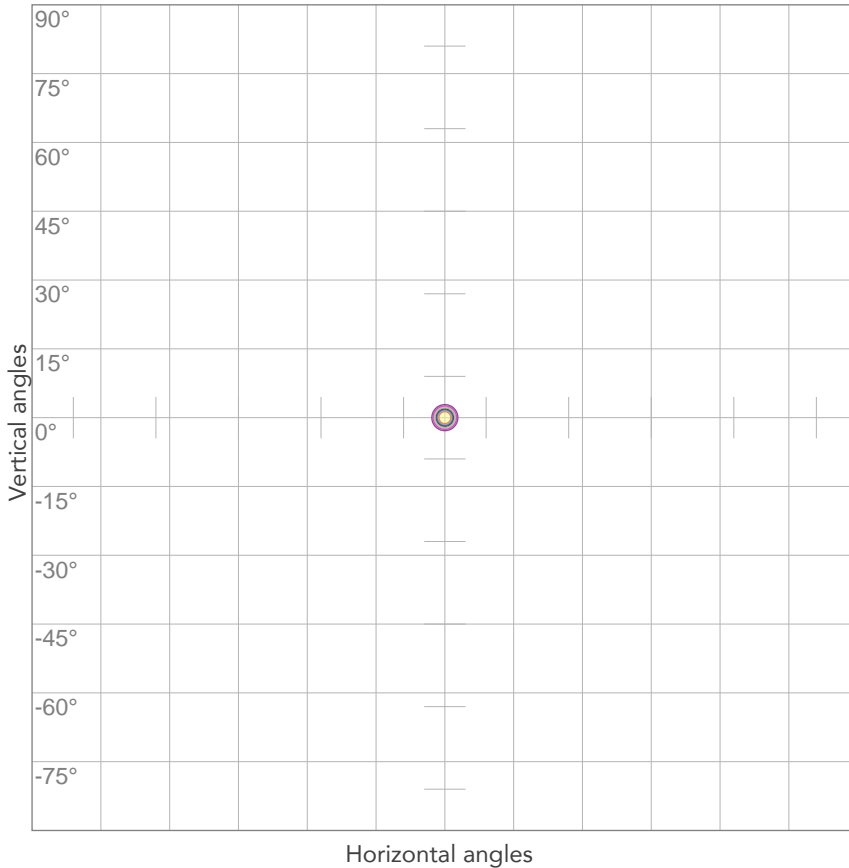

10%	99187 cd
20%	198374 cd
30%	297562 cd
40%	396749 cd
50%	495936 cd
60%	595123 cd
70%	694310 cd
80%	793498 cd

Conditions:

Number of c-planes: 2

Candela at center: 991872 cd

ISO LUX DIAGRAM

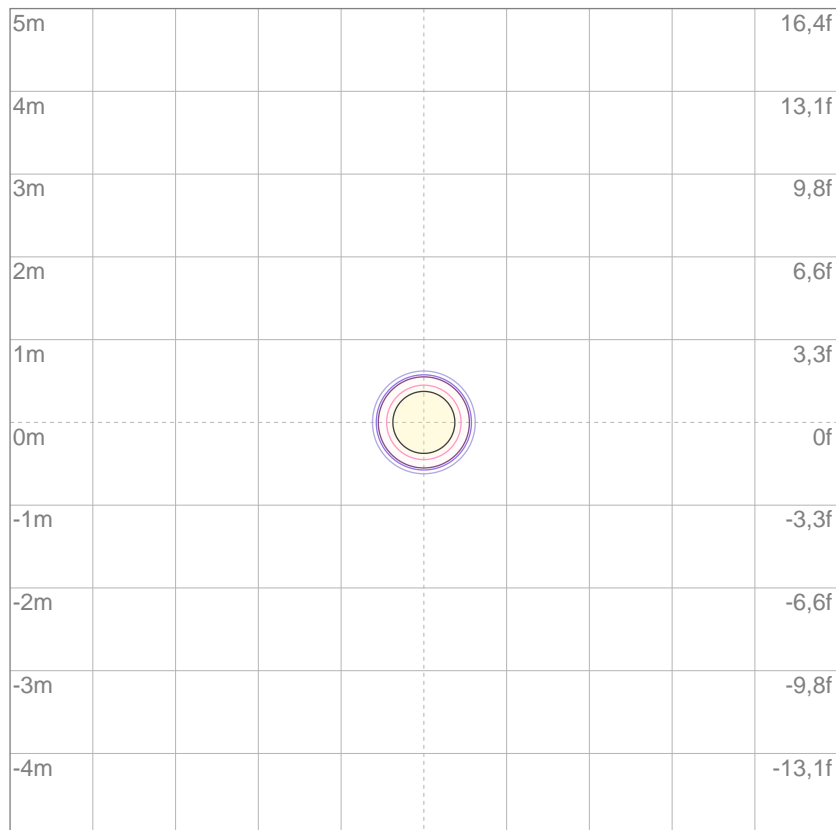

Mounting height: 10 meters (33 feet)

3%	298 lx
5%	496 lx
10%	992 lx
30%	2976 lx
50%	4959 lx

Conditions:

Number of c-planes: 2

Lux at center: 9919 lx

Lux distribution on a surface when lamp is mounted at 10 meters from the surface.



Total lumen output:

8762 lm

Peak candela output:

25396 cd

Light quality:

CRI: 57,3

Color temperature:

6056 K

PRODUCT NAME:

ASTRAWASH19PIX

MEASURAMENT CONDITIONS:

Beam angle:

Max Zoom

Target:

6000K

Operator:

Paolo Carvone

Date and time:

15/02/2021 12:31:33

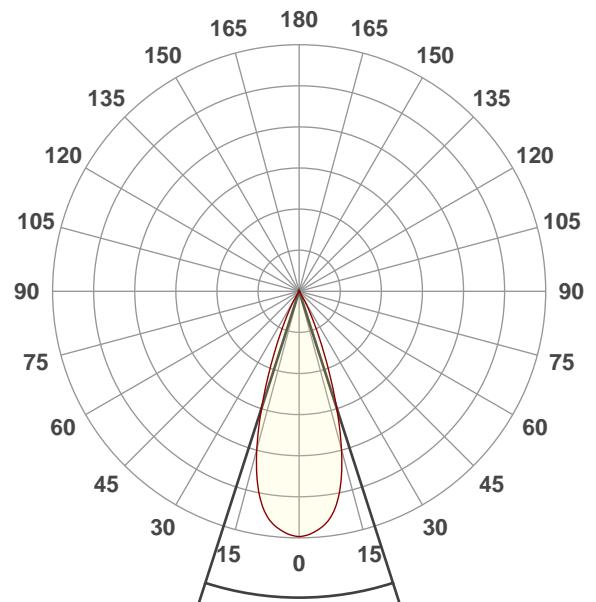

Beam angle 50%: 35,7°

Field angle 10%: 53,8°

Cut off angle 2.5%: 62,3°

Spectra

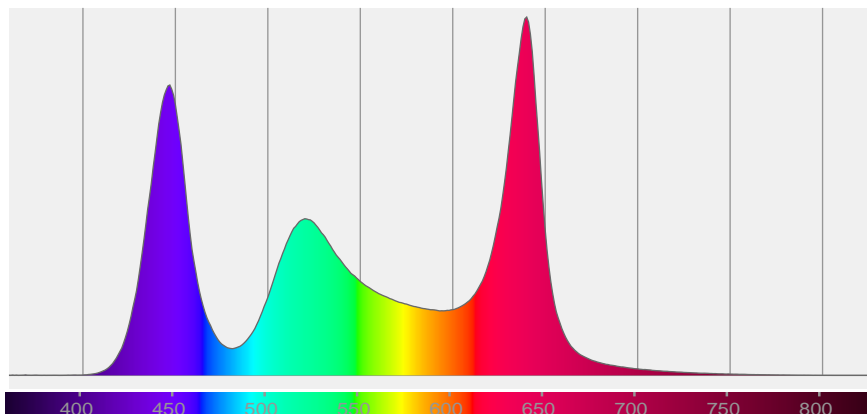

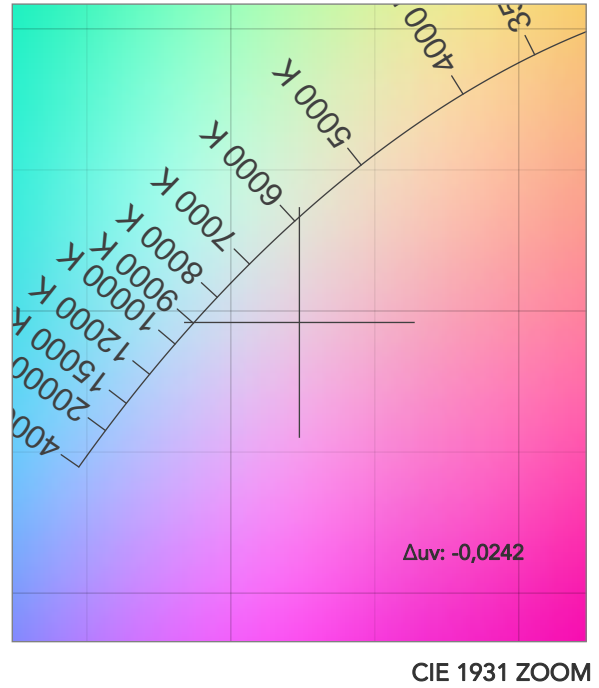
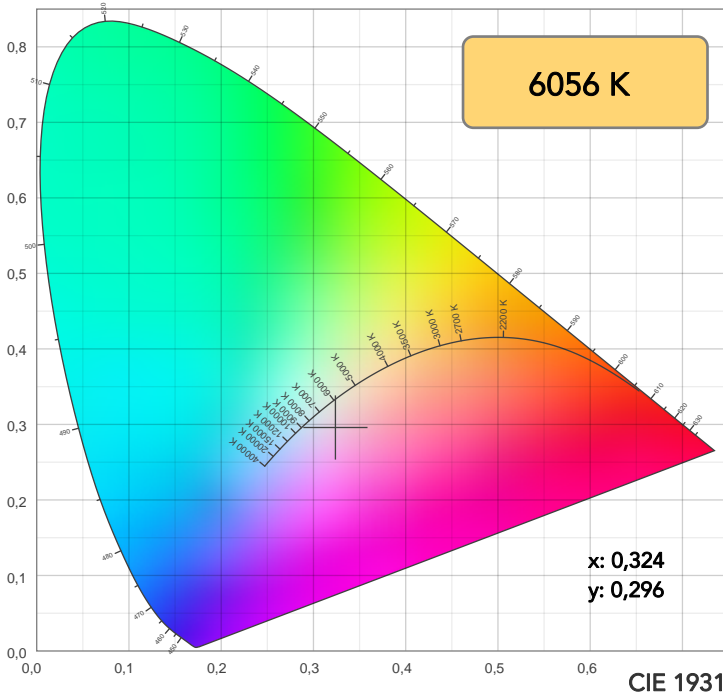

TM30: 69,3

CRI: 57,3 (R1-R8)

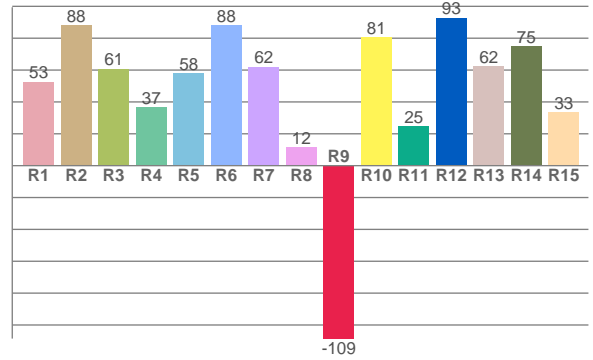
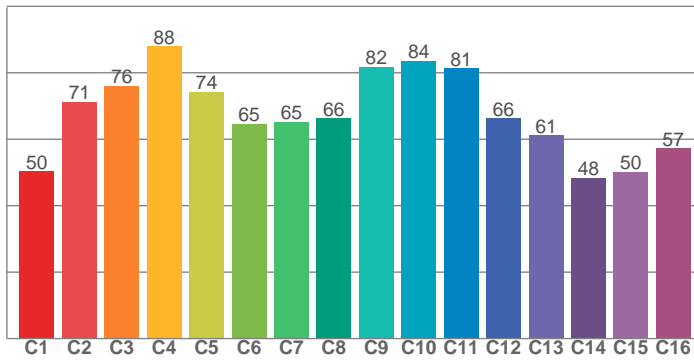

CRI R values, only R1-R8 are used to calculate final CRI value

R1	R2	R3	R4	R5	R6	R7	R8	R9	R10	R11	R12	R13	R14	R15
52,6	88,2	60,8	36,6	57,9	88,3	62,0	11,7	-108,5	80,7	24,6	92,8	62,3	75,0	33,4

TM30 C values, 16 binned values out of total of 99 C values

C1	C2	C3	C4	C5	C6	C7	C8	C9	C10	C11	C12	C13	C14	C15	C16
50,3	71,2	76,1	88,0	74,3	64,7	65,2	66,3	81,8	83,6	81,4	66,2	61,1	48,3	50,2	57,2

CQS Q values

Q1	Q2	Q3	Q4	Q5	Q6	Q7	Q8	Q9	Q10	Q11	Q12	Q13	Q14	Q15
77,8	86,0	81,3	92,1	76,2	78,7	94,6	75,4	71,5	89,5	93,1	83,3	80,5	84,3	83,7

CQS: 81,9

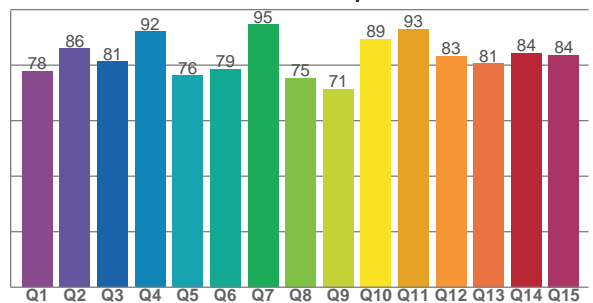

COLOR PARAMETERS

Color temperature	Color rendering index	Red component	Color fidelity	Color gamut	Color quality scale	Television lighting index	Color coordinate cie 1931	Color coordinate cie 1931	Color deviation from black body
CCT	CRI	CRI R9	TM30 Rf	TM30 Rg	CQS	TLCI	x	y	Δuv
6056 K	57,3	-108,5	69,3	126,4	81,9	52	0,324	0,296	-0,0242

TM30 DETAILS

Rf 69,3
Fidelity index Rf

Rg 126,4
Gammut index

Hue Bin	R _f	Graphic shifts (%)	
		Chroma	Hue
1	50	23%	-2%
2	71	13%	-8%
3	76	10%	-5%
4	88	3%	5%
5	74	10%	10%
6	65	19%	13%
7	65	21%	2%
8	66	18%	-4%
9	82	10%	-10%
10	84	1%	-7%
11	81	-1%	10%
12	66	-2%	21%
13	61	4%	31%
14	48	13%	27%
15	50	31%	30%
16	57	22%	4%

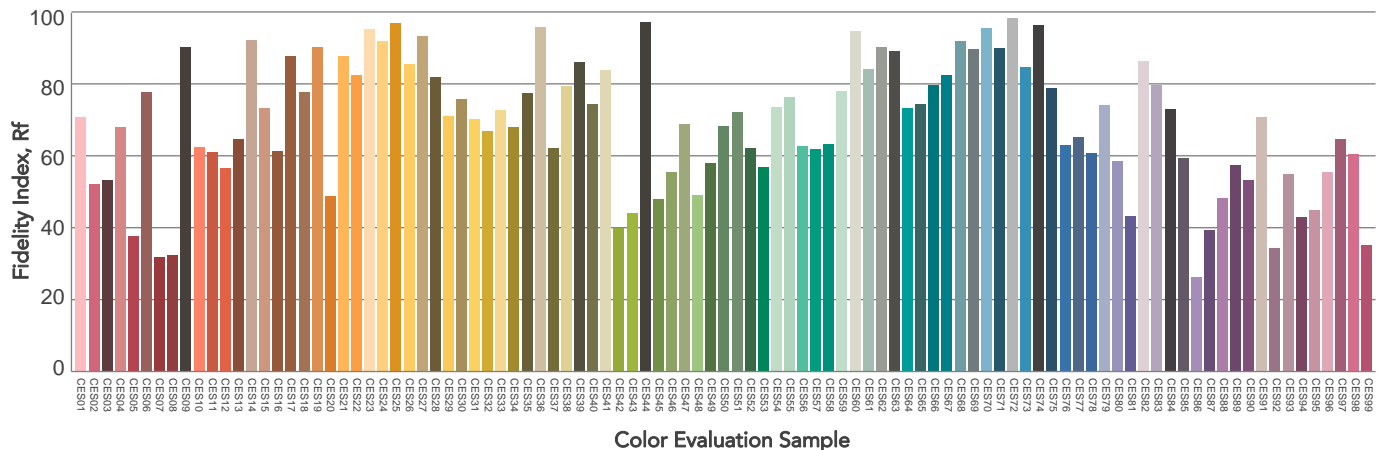
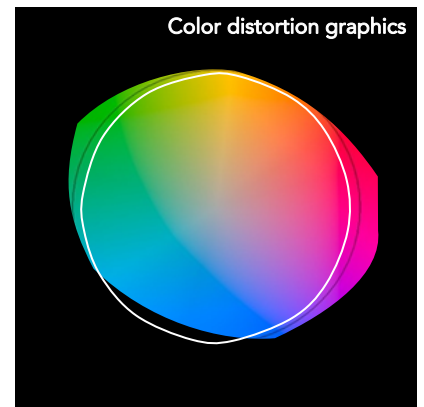
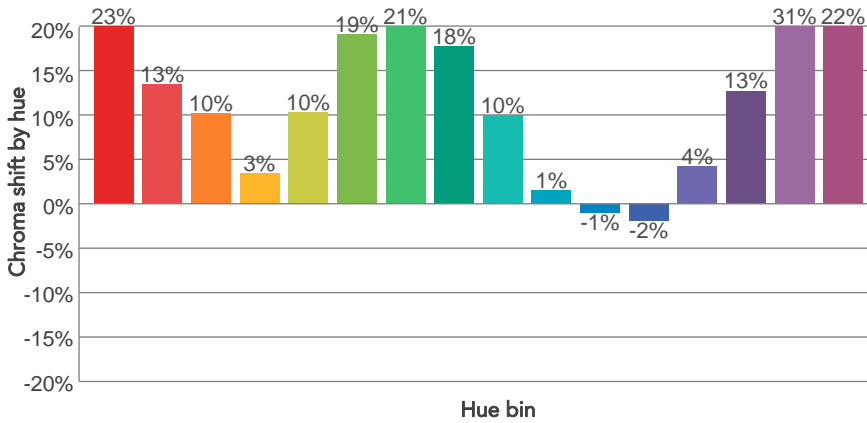
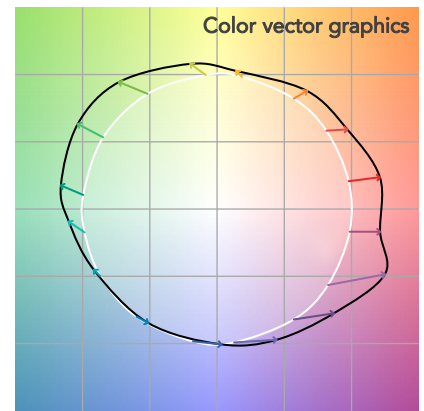
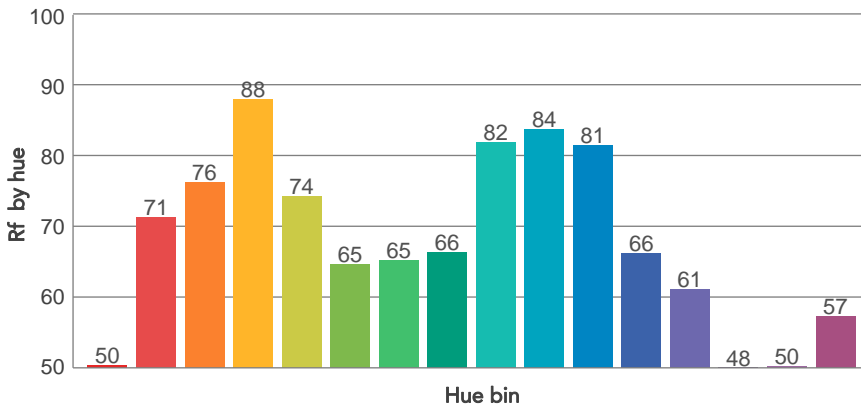
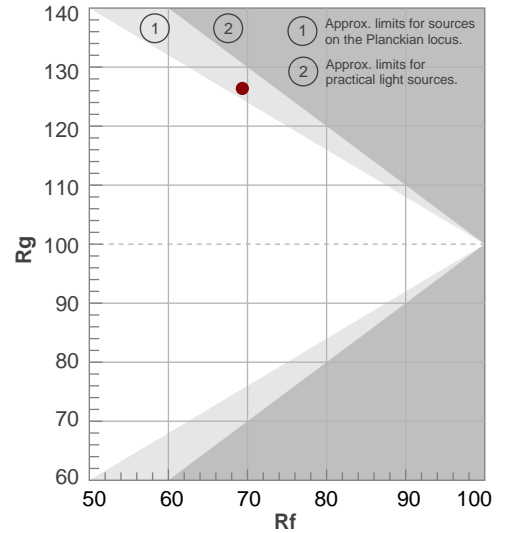

BEAM DETAILS



Beam angle 50%	Field angle 10%	Cut off angle 2,5%	Intensity ratio in 120° cone	Intensity ratio in 90° cone
35,7°	53,8°	62,3°	100,0%	100,0%

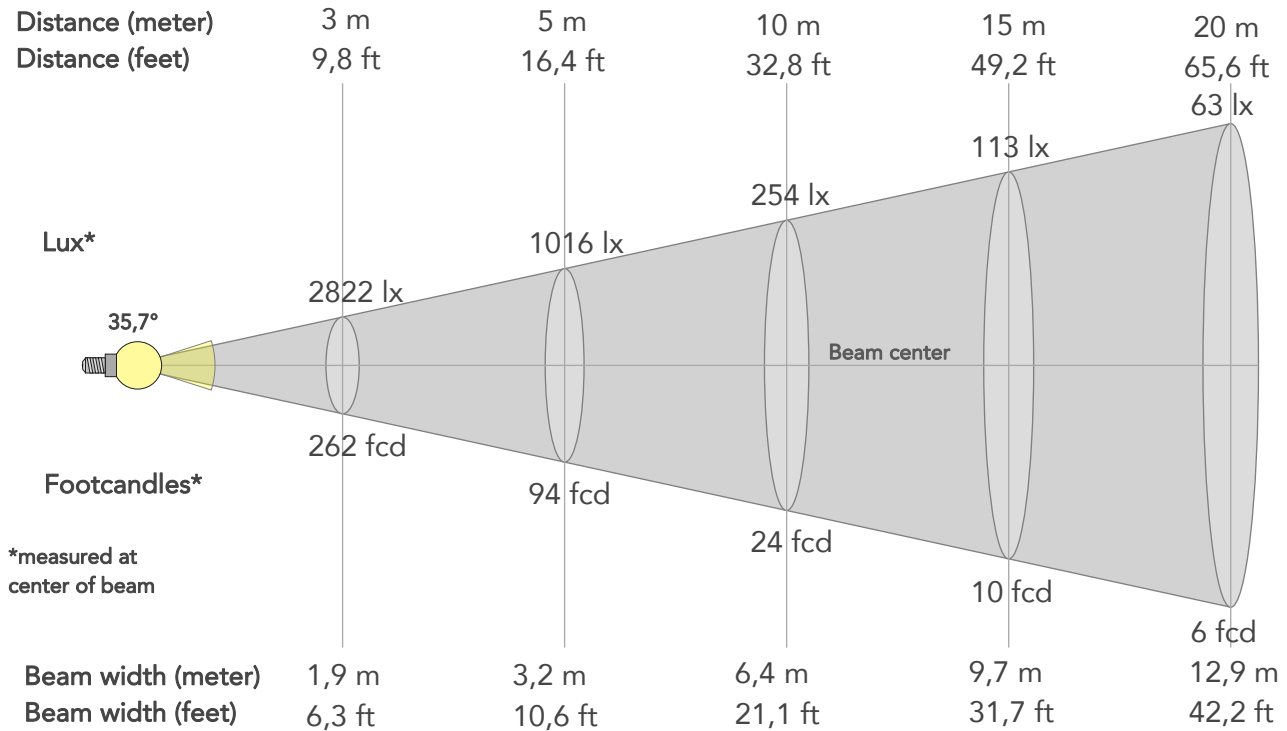

BEAM INTENSITIES AND WIDTHS

Distance	1m	2m	3m	4m	5m	7,5m	10m	15m	20m	25m	30m	40m	50m
Distance	3,3ft	6,6ft	9,8ft	13,1ft	16,4ft	24,6ft	32,8ft	49,2ft	65,6ft	82ft	98,4ft	131,2ft	164ft
Lux	2539lx	6349lx	2822lx	1587lx	1016lx	451lx	254lx	113lx	63lx	41lx	28lx	16lx	10lx
Footcand.	2359fcd	590fcd	262fcd	147fcd	94fcd	42fcd	24fcd	10fcd	6fcd	4fcd	3fcd	1fcd	1fcd
Beam wid.	0,6m	1,3m	1,9m	2,6m	3,2m	4,8m	6,4m	9,7m	12,9m	16,1m	19,3m	25,7m	32,2m
Beam wid.	2,1ft	4,2ft	6,3ft	8,4ft	10,6ft	15,8ft	21,1ft	31,7ft	42,2ft	52,8ft	63,3ft	84,4ft	105,5ft

LINEAR DISTRIBUTION DIAGRAM

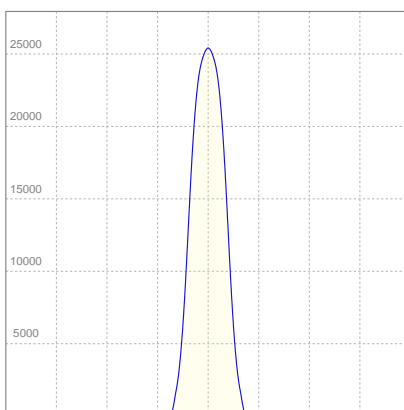

ELECTRICAL SPECIFICATIONS

Input voltage	Input current	Input power	Effeciency
221V	2,16A	452,4W	19lm/W

ISO CANDELA DIAGRAM

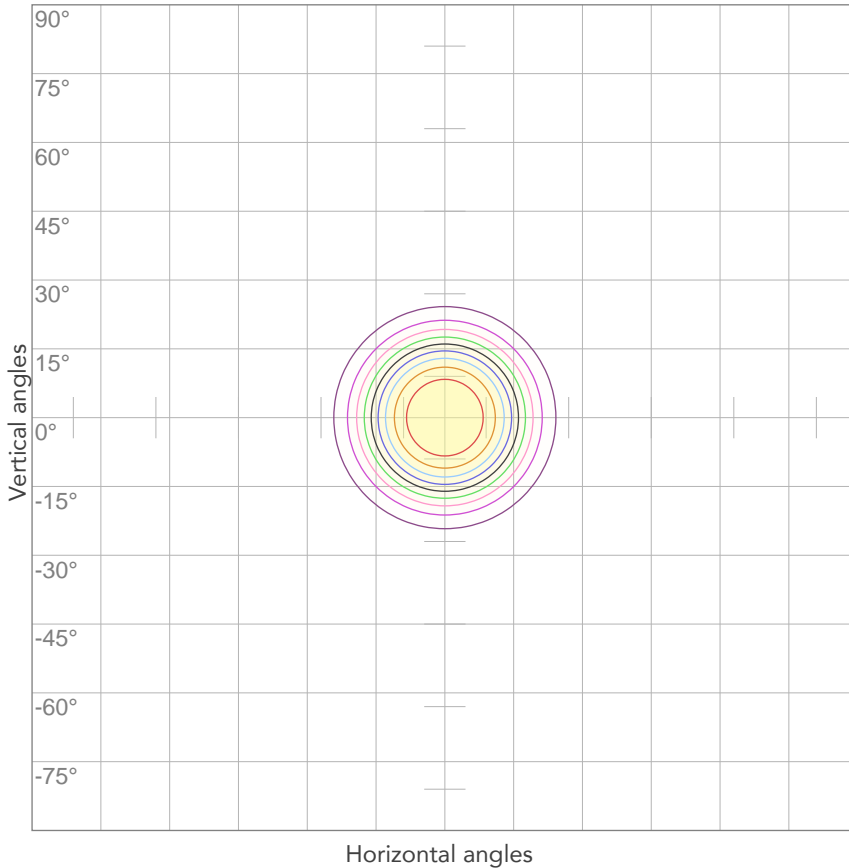

10%	2540 cd
20%	5079 cd
30%	7619 cd
40%	10159 cd
50%	12698 cd
60%	15238 cd
70%	17777 cd
80%	20317 cd

Conditions:

Number of c-planes: 2

Candela at center: 25396 cd

ISO LUX DIAGRAM

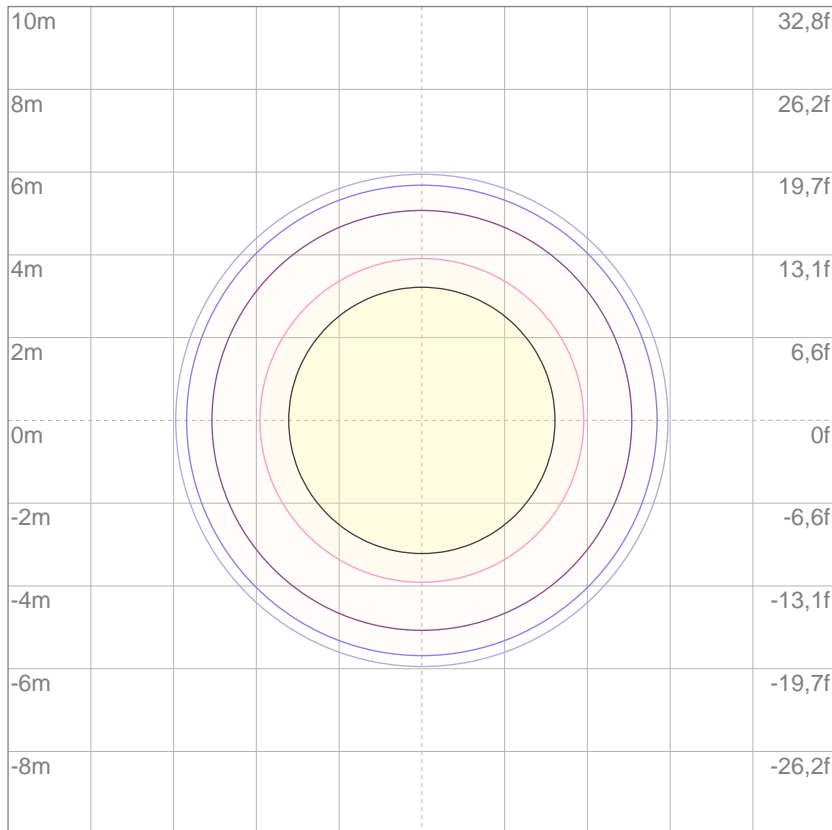

3%	7,62 lx
5%	12,7 lx
10%	25,4 lx
30%	76,2 lx
50%	127 lx

Conditions:

Number of c-planes: 2

Lux at center: 254 lx

Lux distribution on a surface when lamp is mounted at 10 meters from the surface.

Mounting height: 10 meters (33 feet)



Total lumen output:

7443 lm

Peak candela output:

92592 cd

Light quality:

CRI: 56,5

Color temperature:

6064 K

PRODUCT NAME:

ASTRAWASH19PIX

MEASURAMENT CONDITIONS:

Beam angle:

Med Zoom

Target:

6000K

Operator:

Paolo Carvone

Date and time:

15/02/2021 12:33:34

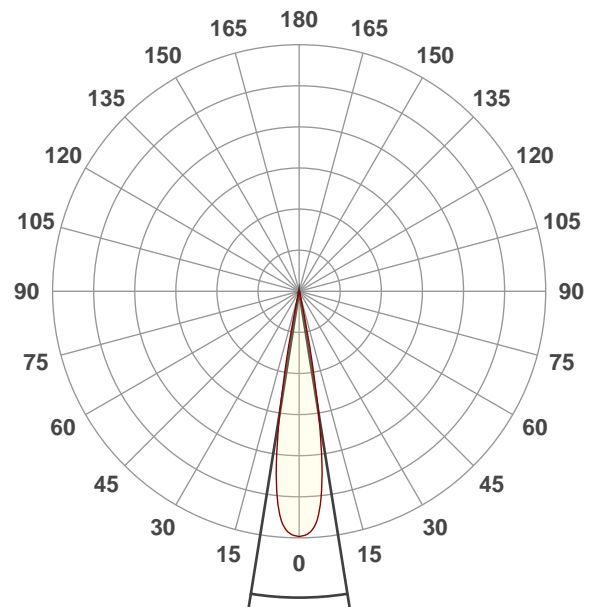

Beam angle 50%: 18,1°

Field angle 10%: 23,9°

Cut off angle 2.5%: 26,5°

Spectra

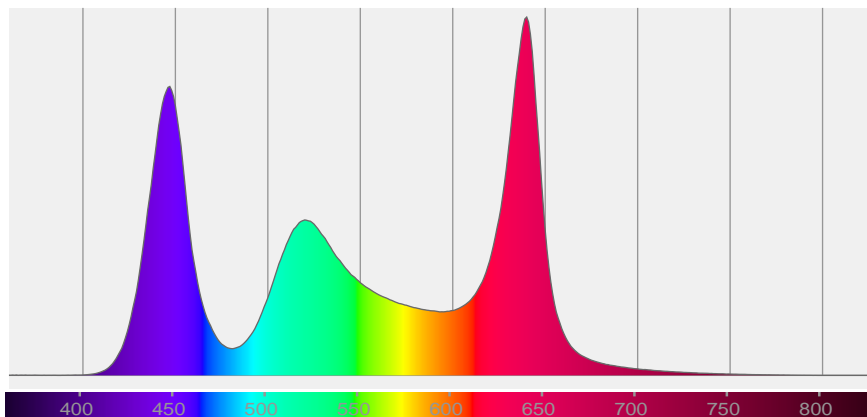

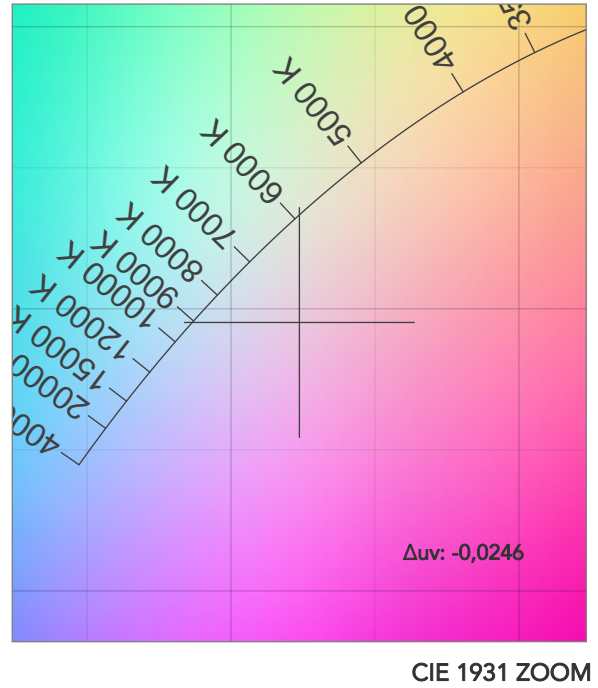
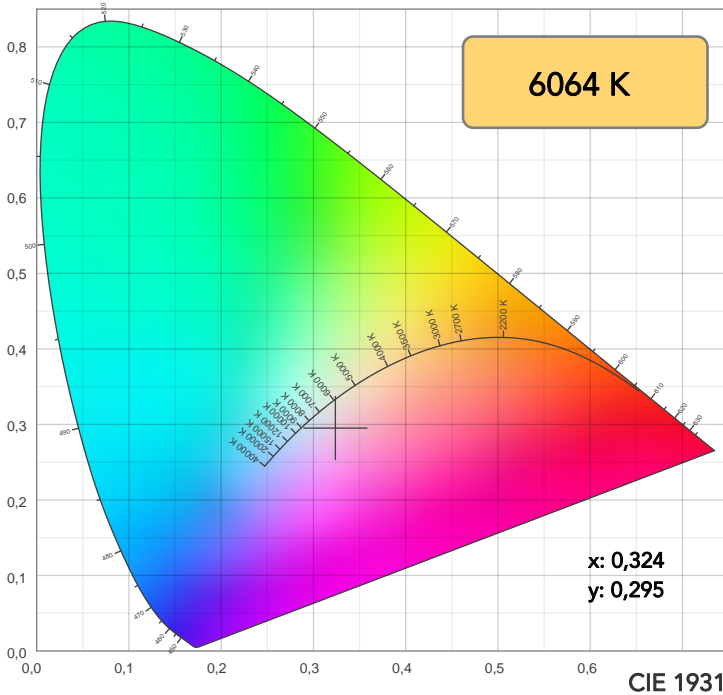

TM30: 69,0

CRI: 56,5 (R1-R8)

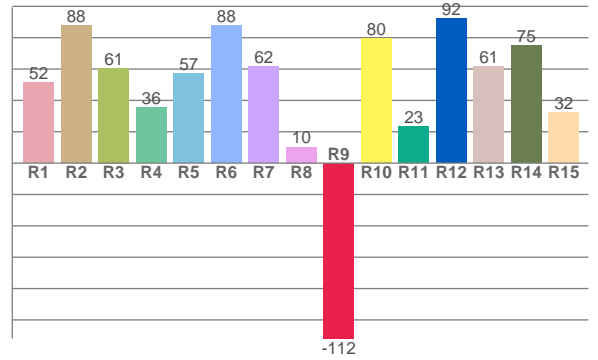
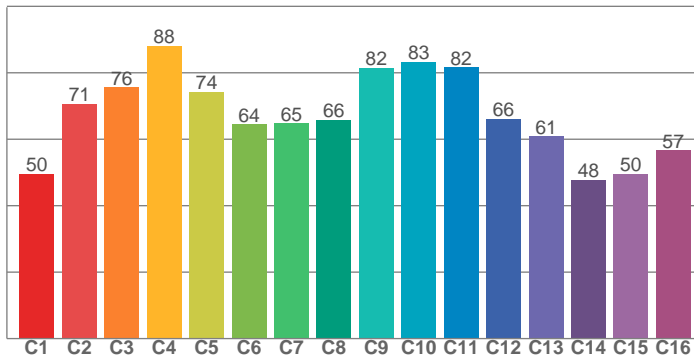

CRI R values, only R1-R8 are used to calculate final CRI value

R1	R2	R3	R4	R5	R6	R7	R8	R9	R10	R11	R12	R13	R14	R15
51,6	87,7	60,6	35,6	57,0	87,7	61,7	10,4	-111,9	79,7	23,5	92,0	61,4	74,9	32,2

TM30 C values, 16 binned values out of total of 99 C values

C1	C2	C3	C4	C5	C6	C7	C8	C9	C10	C11	C12	C13	C14	C15	C16
49,6	70,7	75,6	88,1	74,3	64,4	64,8	65,8	81,5	83,2	81,6	66,2	60,8	47,8	49,6	56,7

CQS Q values

Q1	Q2	Q3	Q4	Q5	Q6	Q7	Q8	Q9	Q10	Q11	Q12	Q13	Q14	Q15
77,4	85,9	81,5	91,7	75,9	78,7	94,3	74,9	71,3	89,7	92,7	82,9	80,2	84,0	83,4

CQS: 81,7

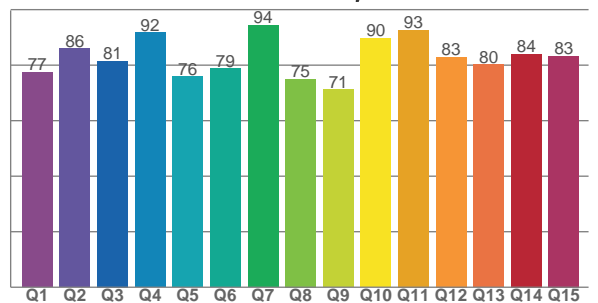

COLOR PARAMETERS

Color temperature	Color rendering index	Red component	Color fidelity	Color gamut	Color quality scale	Television lighting index	Color coordinate cie 1931	Color coordinate cie 1931	Color deviation from black body
CCT	CRI	CRI R9	TM30 Rf	TM30 Rg	CQS	TLCI	x	y	Δuv
6064 K	56,5	-111,9	69,0	126,7	81,7	51	0,324	0,295	-0,0246

TM30 DETAILS

Rf 69,0
Fidelity index Rf

Rg 126,7
Gammut index

Hue Bin	R _f	Graphic shifts (%)	
		Chroma	Hue
1	50	24%	-2%
2	71	14%	-8%
3	76	10%	-5%
4	88	3%	5%
5	74	10%	9%
6	64	19%	13%
7	65	21%	2%
8	66	18%	-4%
9	82	10%	-10%
10	83	2%	-7%
11	82	-1%	10%
12	66	-2%	21%
13	61	4%	31%
14	48	13%	28%
15	50	31%	31%
16	57	23%	5%

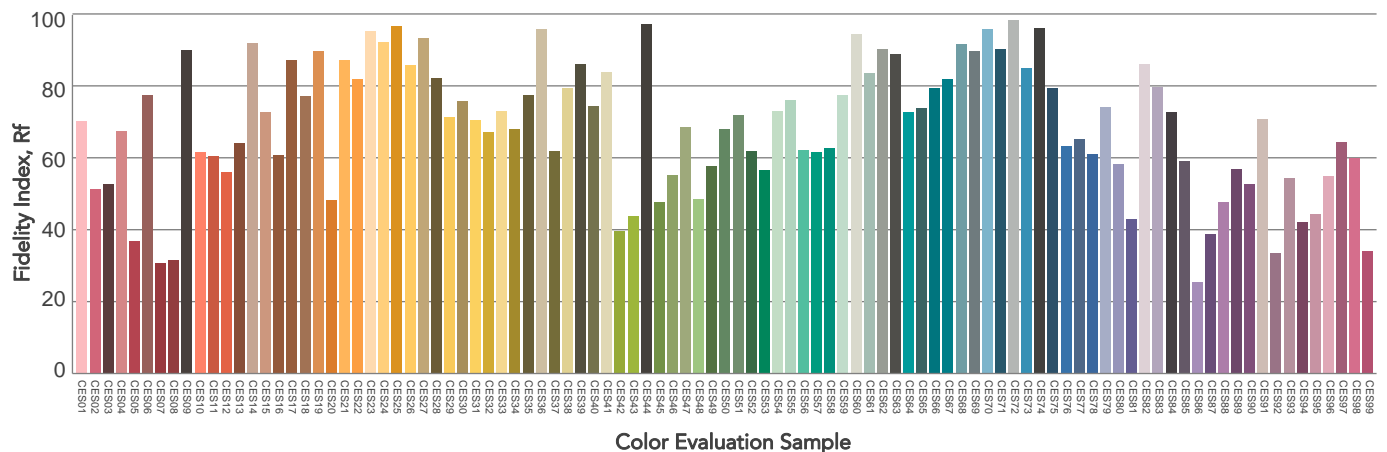
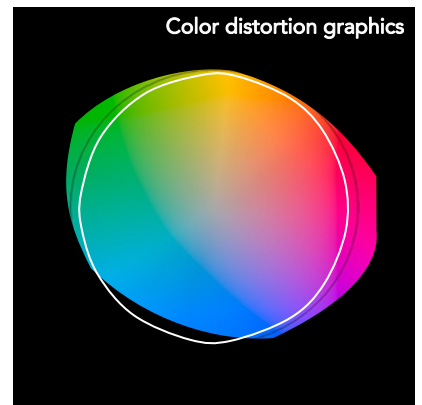
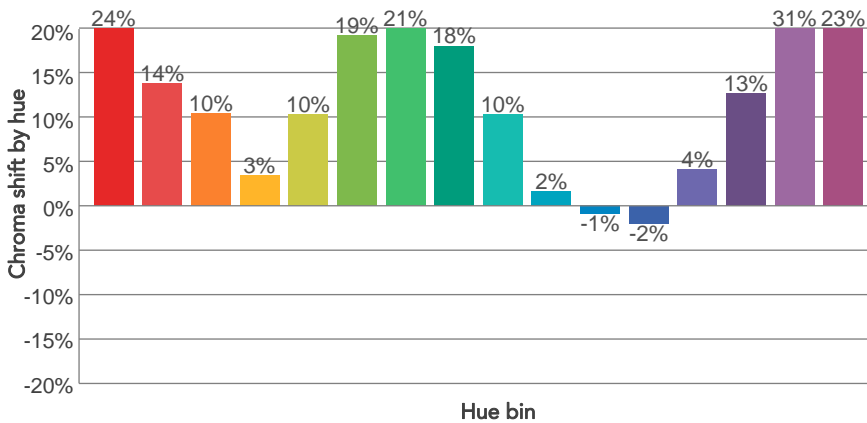
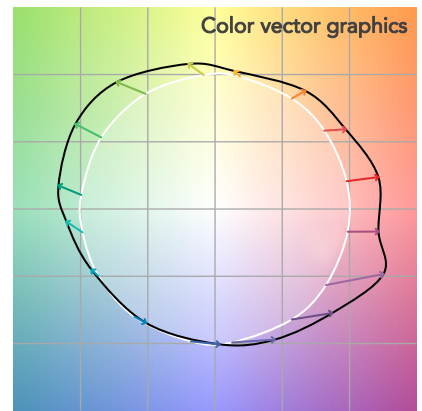
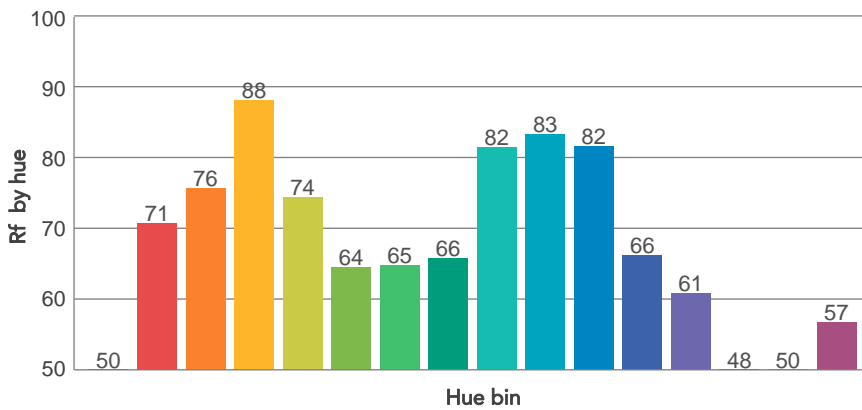
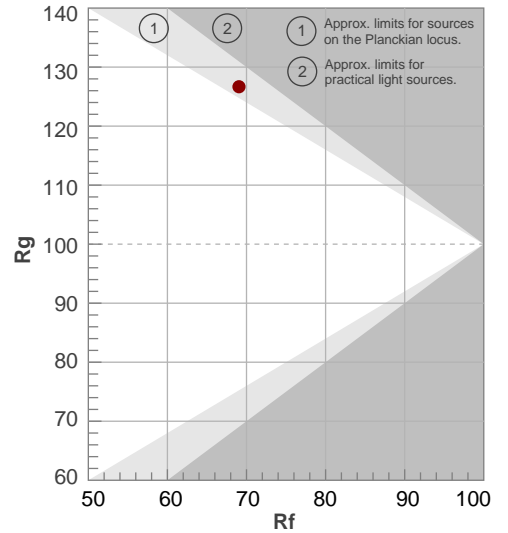

BEAM DETAILS



Beam angle 50%	Field angle 10%	Cut off angle 2,5%	Intensity ratio in 120° cone	Intensity ratio in 90° cone
18,1°	23,9°	26,5°	100,0%	100,0%

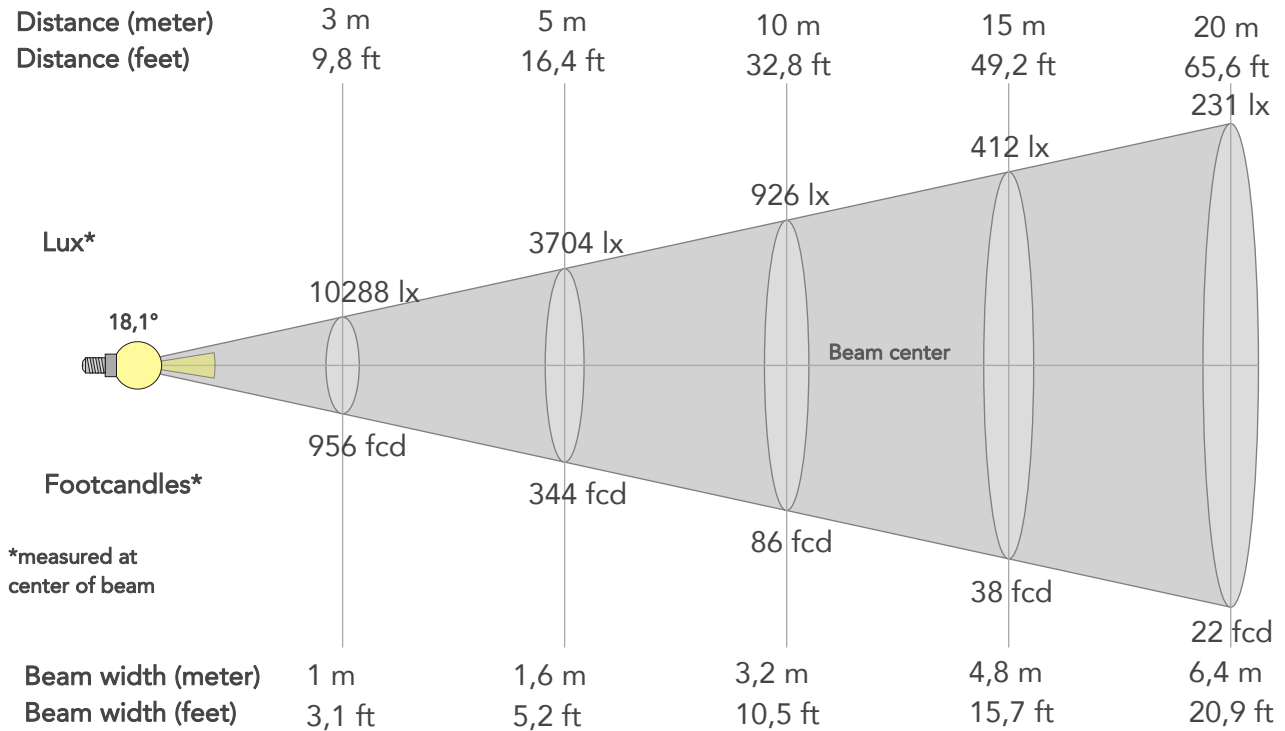

BEAM INTENSITIES AND WIDTHS

Distance	1m	2m	3m	4m	5m	7,5m	10m	15m	20m	25m	30m	40m	50m
Distance	3,3ft	6,6ft	9,8ft	13,1ft	16,4ft	24,6ft	32,8ft	49,2ft	65,6ft	82ft	98,4ft	131,2ft	164ft
Lux	92592lx	23148lx	10288lx	5787lx	3704lx	1646lx	926lx	412lx	231lx	148lx	103lx	58lx	37lx
Footcand.	8602fcd	2151fcd	956fcd	538fcd	344fcd	153fcd	86fcd	38fcd	22fcd	14fcd	10fcd	5fcd	3fcd
Beam wid.	0,3m	0,6m	1m	1,3m	1,6m	2,4m	3,2m	4,8m	6,4m	8m	9,6m	12,8m	16m
Beam wid.	1,1ft	2,1ft	3,1ft	4,2ft	5,2ft	7,9ft	10,5ft	15,7ft	20,9ft	26,2ft	31,4ft	41,9ft	52,4ft

LINEAR DISTRIBUTION DIAGRAM

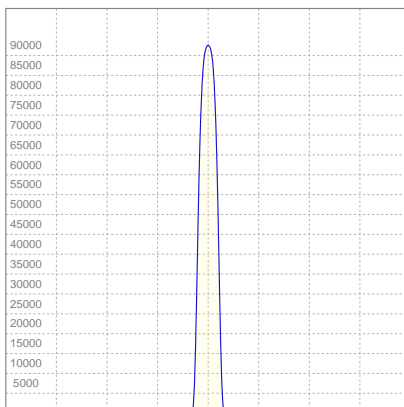

ELECTRICAL SPECIFICATIONS

Input voltage	Input current	Input power	Effeciency
221V	2,16A	452,2W	16lm/W

ISO CANDELA DIAGRAM

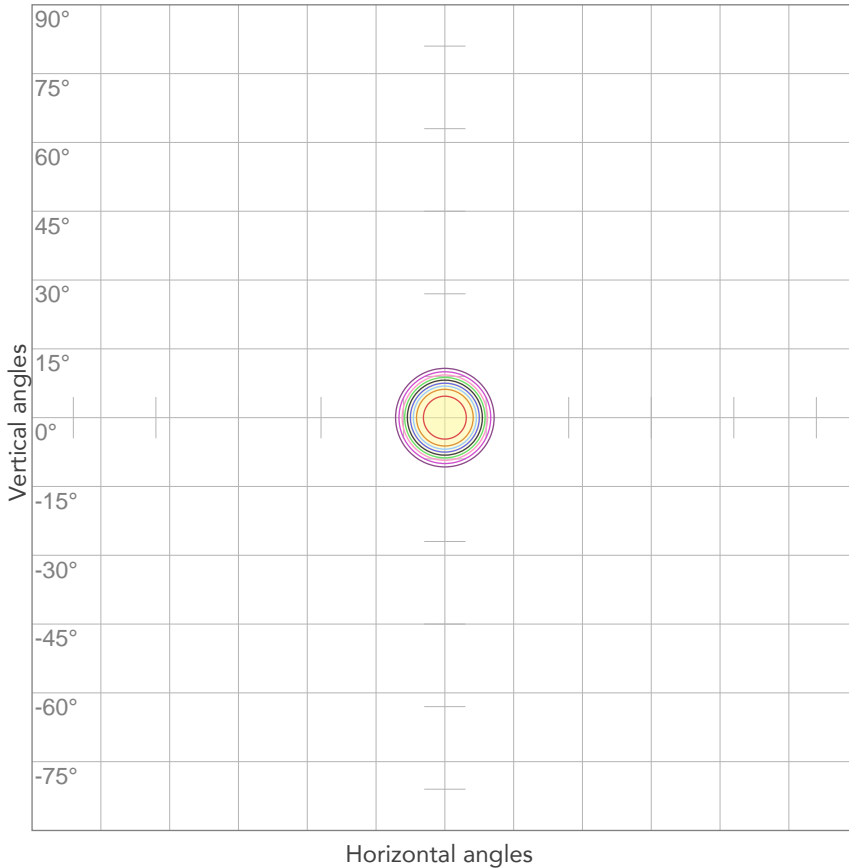

10%	9259 cd
20%	18518 cd
30%	27778 cd
40%	37037 cd
50%	46296 cd
60%	55555 cd
70%	64814 cd
80%	74073 cd

Conditions:

Number of c-planes: 2

Candela at center: 92592 cd

ISO LUX DIAGRAM

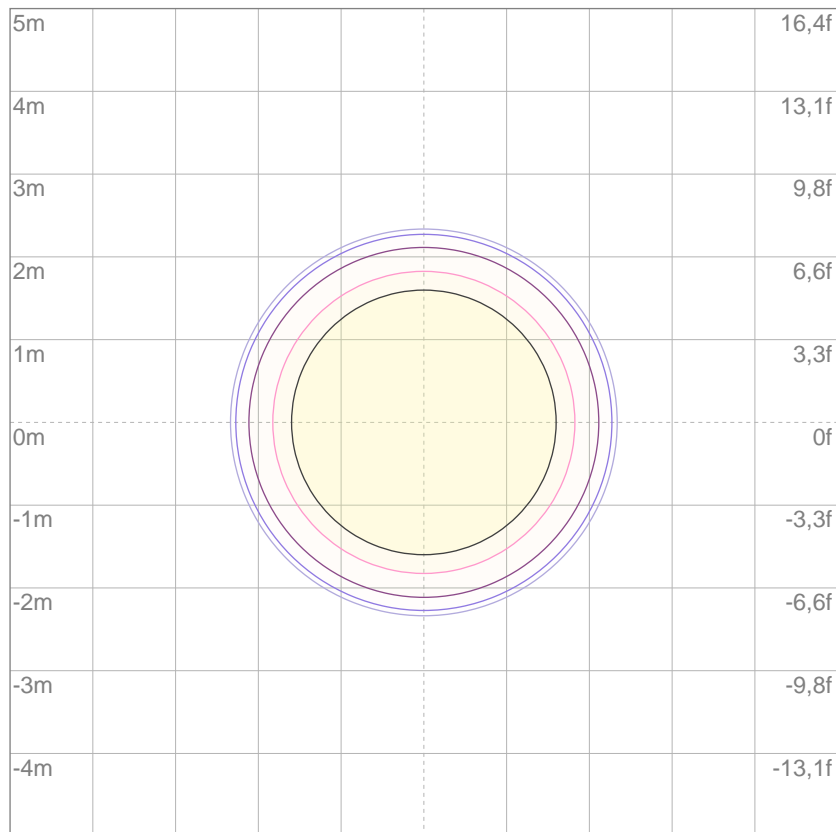

3%	27,8 lx
5%	46,3 lx
10%	92,6 lx
30%	278 lx
50%	463 lx

Conditions:

Number of c-planes: 2

Lux at center: 926 lx

Lux distribution on a surface when lamp is mounted at 10 meters from the surface.

Mounting height: 10 meters (33 feet)



Total lumen output:

4799 lm

Peak candela output:

991329 cd

Light quality:

CRI: 54,9

Color temperature:

6078 K

PRODUCT NAME:

ASTRAWASH19PIX

MEASUREMENT CONDITIONS:

Beam angle:

Min Zoom

Target:

6000K

Operator:

Paolo Carvone

Date and time:

15/02/2021 11:56:30

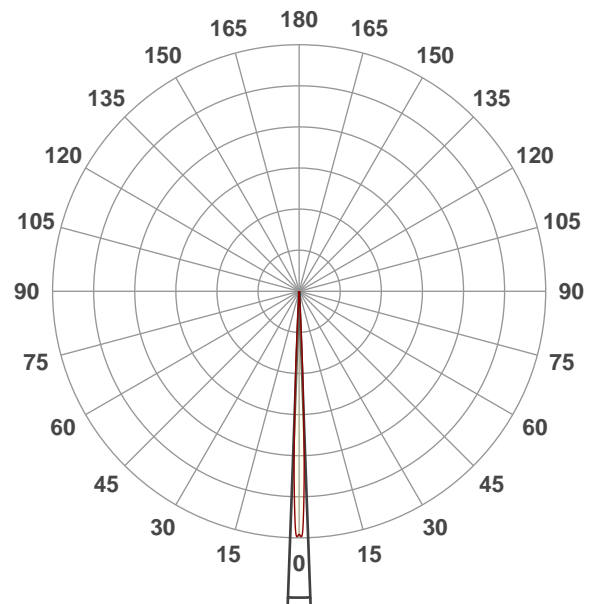

Beam angle 50%: 4,2°

Field angle 10%: 6,3°

Cut off angle 2.5%: 7°

Spectra

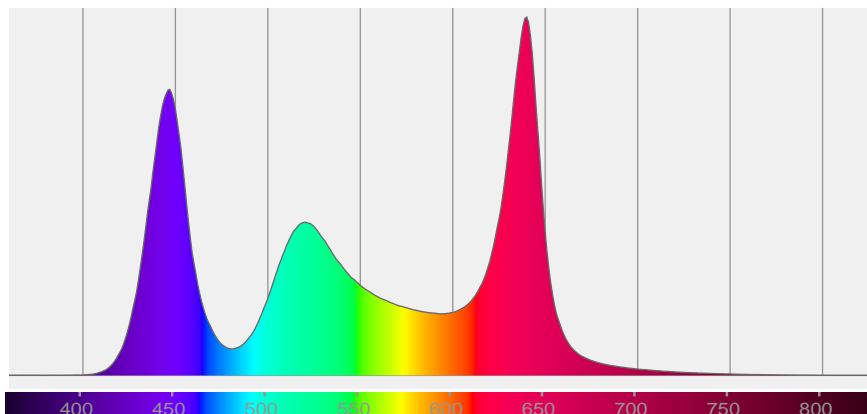

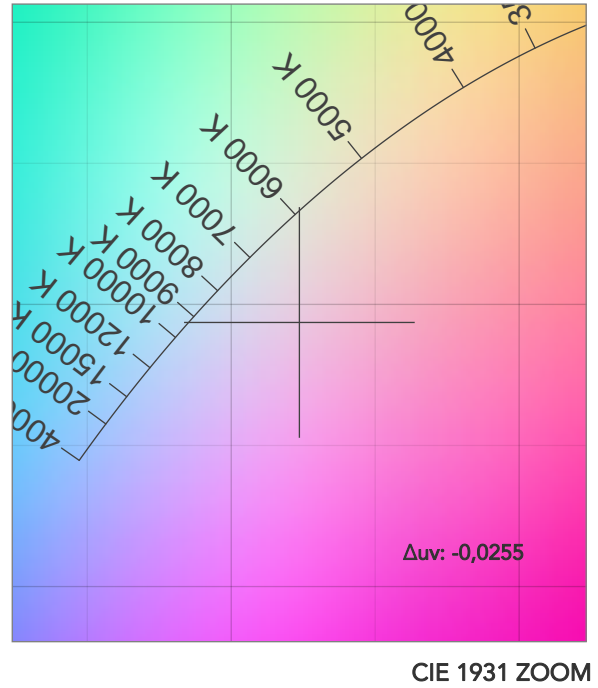
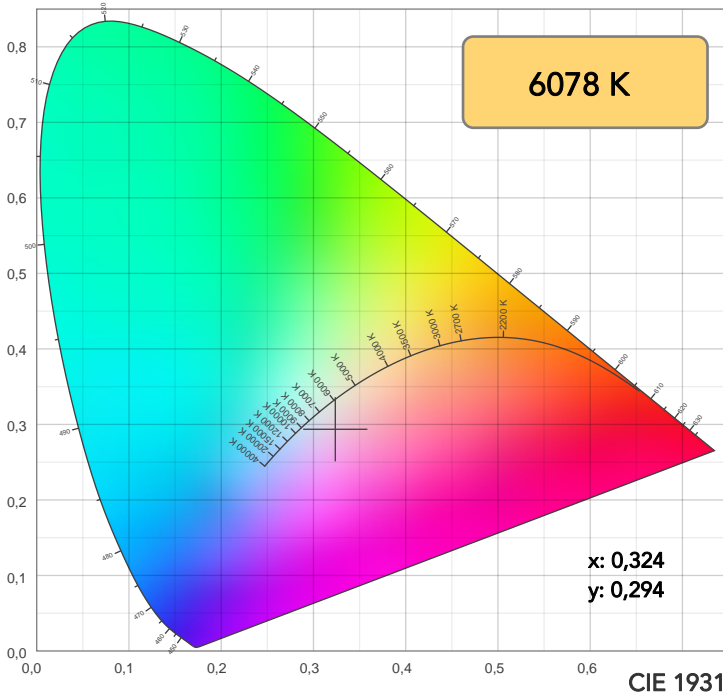

TM30: 68,4

CRI: 54,9 (R1-R8)

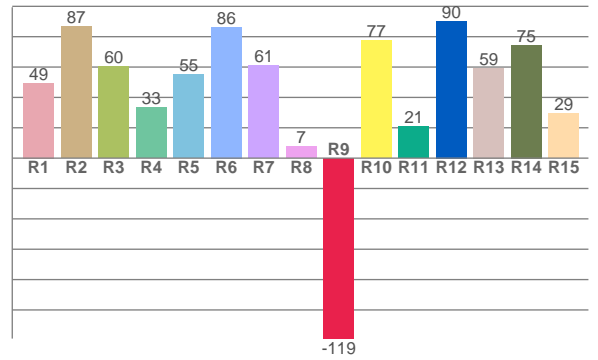
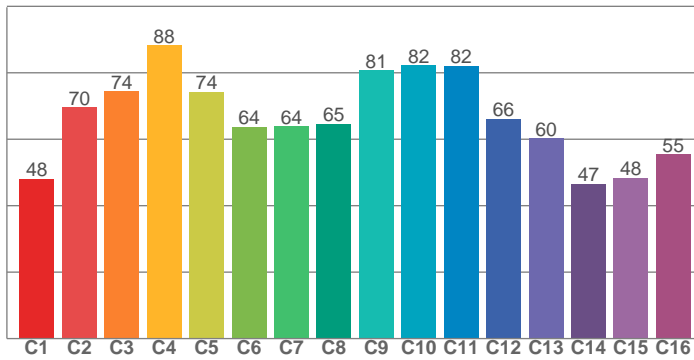

CRI R values, only R1-R8 are used to calculate final CRI value

R1	R2	R3	R4	R5	R6	R7	R8	R9	R10	R11	R12	R13	R14	R15
49,5	86,7	60,3	33,5	54,9	86,4	60,8	7,4	-118,9	77,4	20,7	90,3	59,4	74,6	29,5

TM30 C values, 16 binned values out of total of 99 C values

C1	C2	C3	C4	C5	C6	C7	C8	C9	C10	C11	C12	C13	C14	C15	C16
48,0	69,5	74,4	88,2	74,3	63,7	63,9	64,6	80,8	82,2	82,2	66,1	60,2	46,6	48,4	55,5

CQS Q values

Q1	Q2	Q3	Q4	Q5	Q6	Q7	Q8	Q9	Q10	Q11	Q12	Q13	Q14	Q15
76,6	85,8	81,9	90,6	75,2	78,6	93,7	74,0	70,8	90,1	91,8	81,9	79,5	83,4	82,6

CQS: 81,2

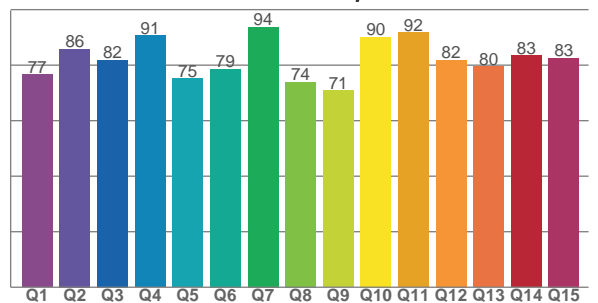

COLOR PARAMETERS

Color temperature	Color rendering index	Red component	Color fidelity	Color gamut	Color quality scale	Television lighting index	Color coordinate cie 1931	Color coordinate cie 1931	Color deviation from black body
CCT	CRI	CRI R9	TM30 Rf	TM30 Rg	CQS	TLCI	x	y	Δuv
6078 K	54,9	-118,9	68,4	127,3	81,2	50	0,324	0,294	-0,0255

TM30 DETAILS

Rf 68,4
Fidelity index Rf

Rg 127,3
Gammut index

Hue Bin	R _f	Graphic shifts (%)	
		Chroma	Hue
1	48	24%	-1%
2	70	14%	-8%
3	74	11%	-6%
4	88	3%	5%
5	74	10%	9%
6	64	19%	13%
7	64	22%	3%
8	65	19%	-3%
9	81	11%	-10%
10	82	2%	-8%
11	82	-1%	9%
12	66	-2%	21%
13	60	4%	32%
14	47	13%	28%
15	48	31%	32%
16	55	23%	5%

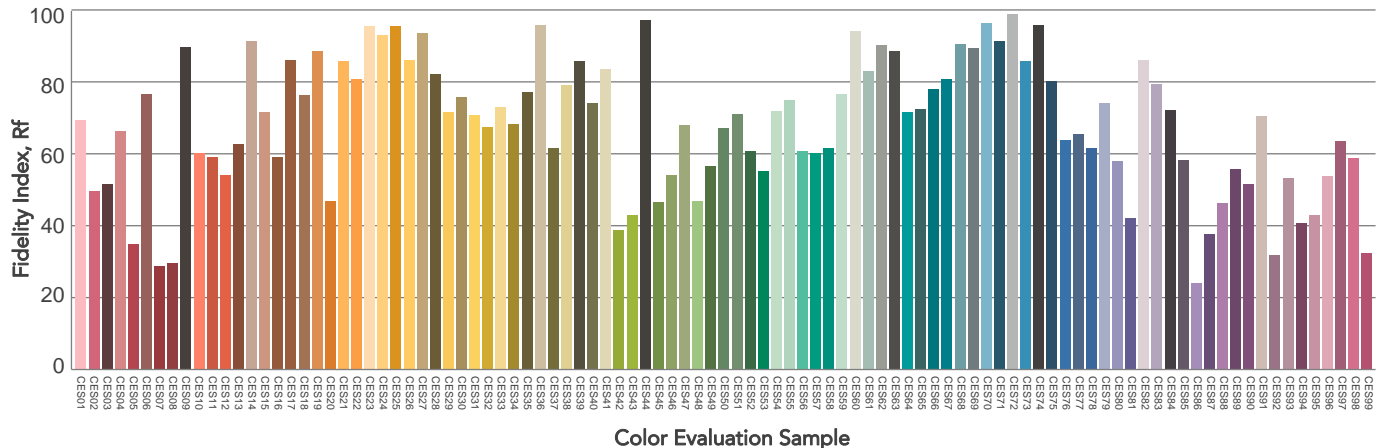
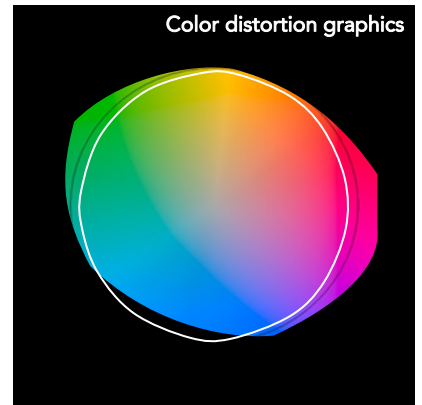
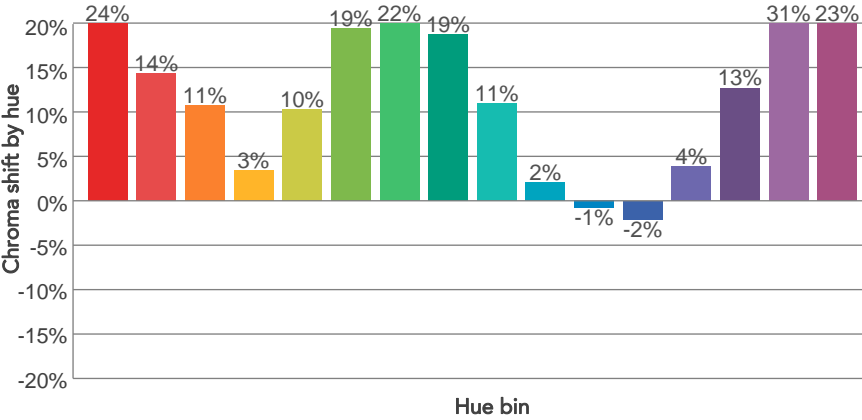
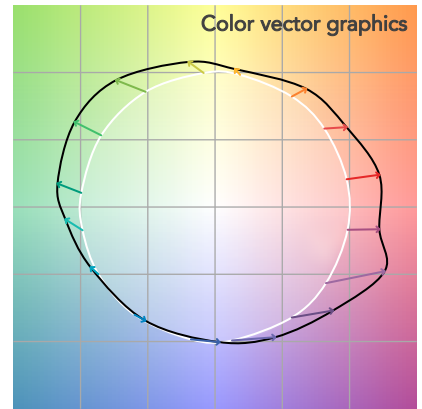
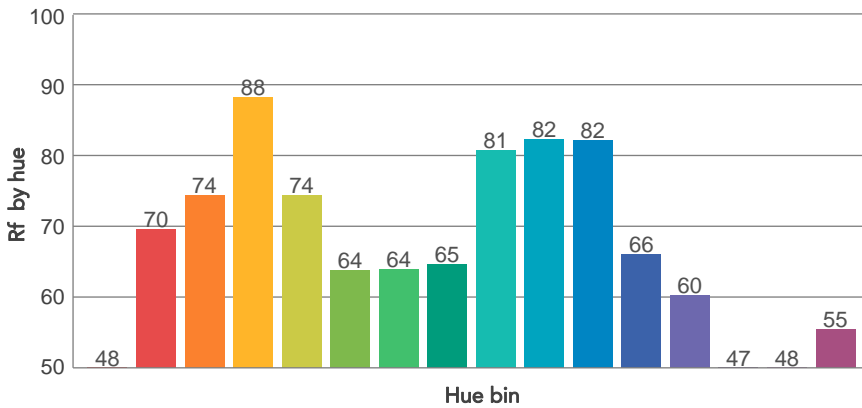
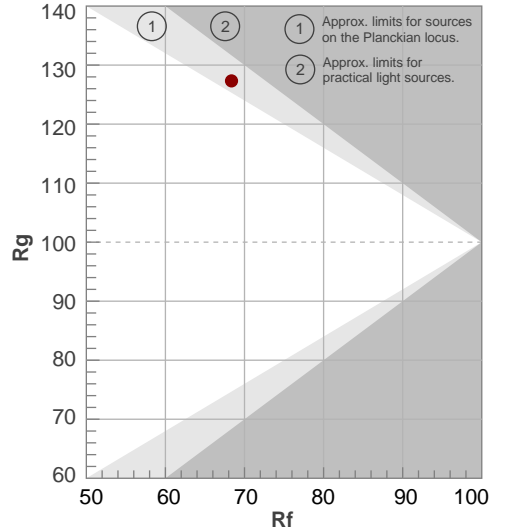

BEAM DETAILS



Beam angle 50%	Field angle 10%	Cut off angle 2,5%	Intensity ratio in 120° cone	Intensity ratio in 90° cone
4,2°	6,3°	7°	100,0%	100,0%

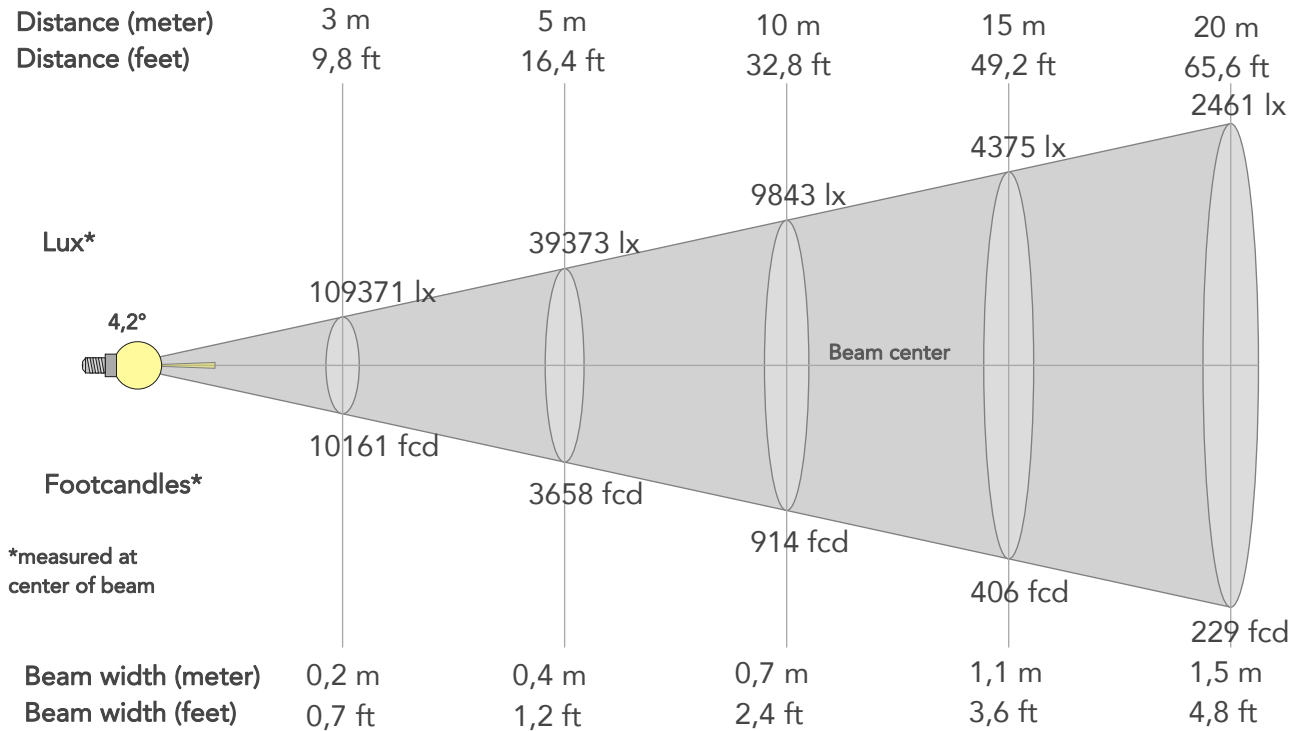

BEAM INTENSITIES AND WIDTHS

Distance	1m	2m	3m	4m	5m	7,5m	10m	15m	20m	25m	30m	40m	50m
Distance	3,3ft	6,6ft	9,8ft	13,1ft	16,4ft	24,6ft	32,8ft	49,2ft	65,6ft	82ft	98,4ft	131,2ft	164ft
Lux	984335lx	246084lx	109371lx	61521lx	39373lx	17499lx	9843lx	4375lx	2461lx	1575lx	1094lx	615lx	394lx
Footcand.	91448fcd	22862fcd	10161fcd	5715fcd	3658fcd	1626fcd	914fcd	406fcd	229fcd	146fcd	102fcd	57fcd	37fcd
Beam wid.	0,1m	0,1m	0,2m	0,3m	0,4m	0,5m	0,7m	1,1m	1,5m	1,8m	2,2m	2,9m	3,6m
Beam wid.	0,2ft	0,5ft	0,7ft	1ft	1,2ft	1,8ft	2,4ft	3,6ft	4,8ft	6ft	7,2ft	9,6ft	12ft

LINEAR DISTRIBUTION DIAGRAM

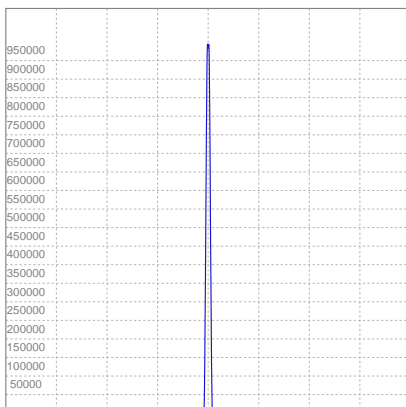

ELECTRICAL SPECIFICATIONS

Input voltage	Input current	Input power	Effeciency
222V	2,16A	452,5W	11lm/W

ISO CANDELA DIAGRAM

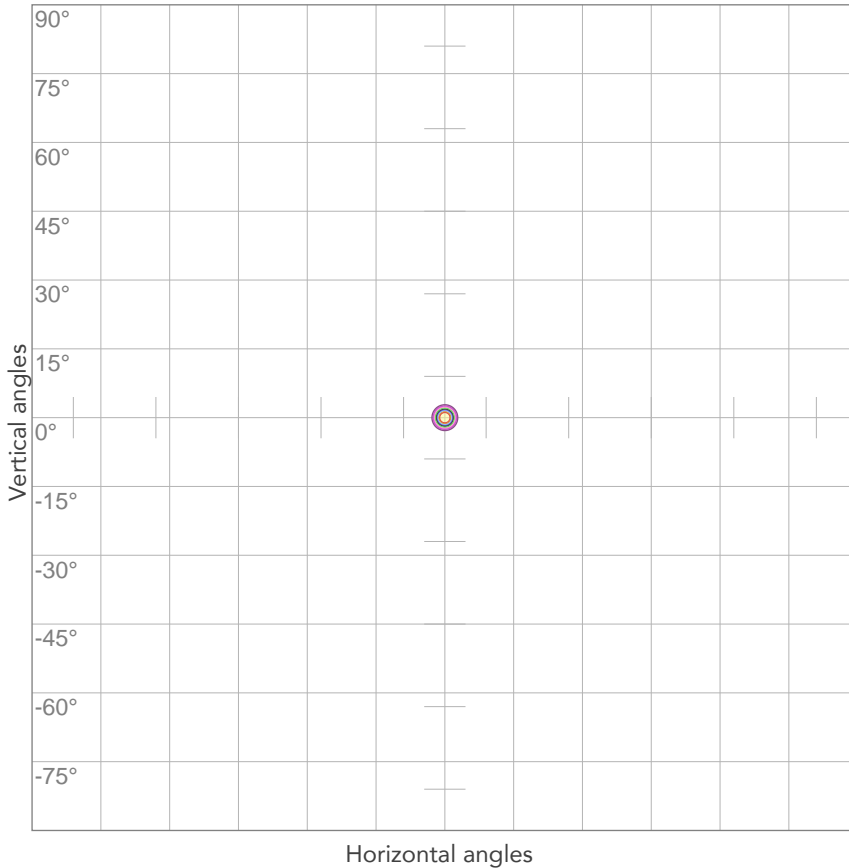

10%	98434 cd
20%	196867 cd
30%	295301 cd
40%	393734 cd
50%	492168 cd
60%	590601 cd
70%	689035 cd
80%	787468 cd

Conditions:

Number of c-planes: 2

Candela at center: 984335 cd

ISO LUX DIAGRAM

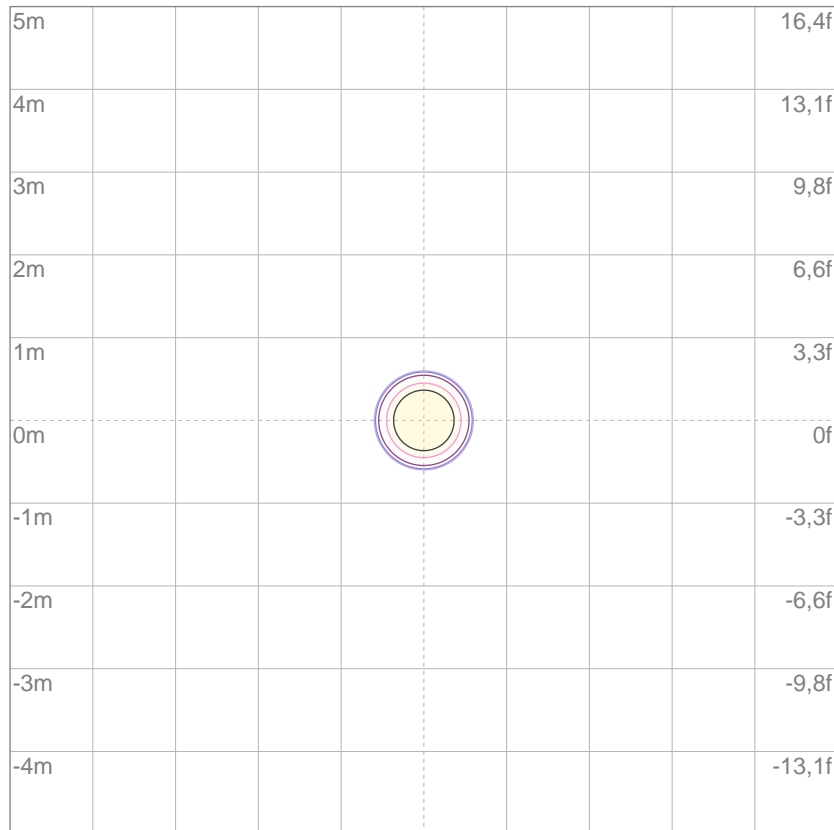

3%	295 lx
5%	492 lx
10%	984 lx
30%	2953 lx
50%	4922 lx

Conditions:

Number of c-planes: 2

Lux at center: 9843 lx

Lux distribution on a surface when lamp is mounted at 10 meters from the surface.

Mounting height: 10 meters (33 feet)