



Hog 4 Lighting Control System

User Manual

Version 3.12.0 - EN

Hog 4 Lighting Control System: User Manual

High End Systems

by Chris Muenchow and Michael Graham

Copyright

© High End Systems, Inc. 2019, All Rights Reserved.

Changes

Information and specifications in this document are subject to change without notice. High End Systems, Inc. assumes no responsibility or liability for any errors or inaccuracies that may appear in this manual.

Trademarks

The High End Systems, Flying Pig Systems, and Hog 4 logos are registered trademarks of High End Systems, Inc.

All other brand names and product names used in this book are trademarks, registered trademarks, or trade names of their respective holders.

FCC Information

The equipment referenced in this manual has been tested and found to comply with the limits for a Class A digital device, pursuant to part 15 of the FCC rules. These limits are designed to provide reasonable protection against harmful interference when the equipment is operated in a commercial environment. This equipment generates, uses, and can radiate radio frequency energy and, if not installed and used in accordance with the instruction manual, may cause harmful interference to radio communications. Operation of this equipment in a residential area is likely to cause harmful interference, in which case the user will be required to correct the interference at his own expense.

Product Modification Warning

High End Systems products are designed and manufactured to meet the requirements of United States and International safety regulations. Modifications to the product could affect safety and render the product non-compliant to relevant safety standards.

Mise En Garde Contre La Modification Du Produit

Les produits High End Systems sont conçus et fabriqués conformément aux exigences des règlements internationaux de sécurité. Toute modification du produit peut entraîner sa non conformité aux normes de sécurité en vigueur.

Produktmodifikationswarnung

Design und Herstellung von High End Systems entsprechen den Anforderungen der U.S. Amerikanischen und internationalen Sicherheitsvorschriften. Abänderungen dieses Produktes können dessen Sicherheit beeinträchtigen und unter Umständen gegen die diesbezüglichen Sicherheitsnormen verstoßen.

Avvertenza Sulla Modifica Del Prodotto

I prodotti di High End Systems sono stati progettati e fabbricati per soddisfare i requisiti delle normative di sicurezza statunitensi ed internazionali. Qualsiasi modifica al prodotto potrebbe pregiudicare la sicurezza e rendere il prodotto non conforme agli standard di sicurezza pertinenti.

Advertencia De Modificación Del Producto

Los productos de High End Systems están diseñados y fabricados para cumplir los requisitos de las reglamentaciones de seguridad de los Estados Unidos e internacionales. Las modificaciones al producto podrían afectar la seguridad y dejar al producto fuera de conformidad con las normas de seguridad relevantes.

製品変更に対する警告

High End Systems 製品はアメリカ合衆国及び、国際安全基準の必要条件を満たすよう設計及び製造されています。この為、製品に対する変更は安全に対して影響を及ぼす場合及び、関連安全基準に満たない状態になる場合があります。

Important Safety Information

Instructions pertaining to continued protection against fire, electric shock, and injury to persons are found in *Safety Warnings* (p.491).

Please read all instructions prior to assembling, mounting, and operating this equipment.

Important: Informations De Sécurité

Les instructions se rapportant à la protection permanente contre les incendies, l'électrocution et aux blessures corporelles se trouvent dans *Informations Importantes Sur La Sécurité* (p.492).

Veuillez lire toutes les instructions avant d'assembler, de monter ou d'utiliser cet équipement.

Wichtige Sicherheitshinweise

Sicherheitsanleitungen zum Schutz gegen Feuer, elektrischen Schlag und Verletzung von Personen finden Sie in *Wichtige Hinweise Für Ihre Sicherheit* (p.492).

Vor der Montage, dem Zusammenbau und der Inbetriebnahme dieses Geräts alle Anleitungen sorgfältig durchlesen.

Informazioni Importanti Di Sicurezza

Le istruzioni sulla protezione da incendi, folgorazione e infortuni sono contenute nell *Sezione 34.5, «Importanti Informazioni Di Sicurezza»*.

Si prega di leggere tutte le istruzioni prima di assemblare, montare e azionare l'apparecchiatura.

Informacion Importante De Seguridad

En el *Información Importante De Seguridad* (p.493) se encuentran instrucciones sobre protección continua contra incendios, descarga eléctrica y lesiones personales.

Lea, por favor, todas las instrucciones antes del ensamblaje, montaje y operación de este equipo.

重要な安全に関する情報

継続した火災、感電、及び、人の負傷からの保護に関する指示は、*安全に関する情報* (p.495) を参照して下さい。

この装置を組み立て、設置、操作等を行う前に全ての指示を読んで下さい。

Warranty Information

Limited Warranty: Unless otherwise stated, your product is covered by a two year parts and labour limited warranty. It is the owner's responsibility to furnish receipts or invoices for verification of purchase, date, and dealer or distributor. If purchase date cannot be provided, date of manufacture will be used to determine warranty period.

Returning an Item Under Warranty for Repair: It is necessary to obtain a Return Material Authorization (RMA) number from your dealer or point of purchase BEFORE any units are returned for repair. The manufacturer will make the final determination as to whether or not the unit is covered by warranty.

Any Product unit or parts returned to High End Systems must be packaged in a suitable manner to ensure the protection of such Product unit or parts, and such package shall be clearly and prominently marked to indicate that the package contains returned Product units or parts and with an RMA number. Accompany all returned

Product units or parts with a written explanation of the alleged problem or malfunction. Ship returned Product units or parts to: 2105 Gracy Farms Lane, Austin, Texas 78758, USA.

Note: Freight Damage Claims are invalid for products shipped in non-factory boxes and packing materials.

Freight: All shipping will be paid by the purchaser. Under no circumstances will freight collect shipments be accepted.

REPAIR OR REPLACEMENT AS PROVIDED FOR UNDER THIS WARRANTY IS THE EXCLUSIVE REMEDY OF THE CONSUMER. HIGH END SYSTEMS, INC. MAKES NO WARRANTIES, EXPRESS OR IMPLIED, WITH RESPECT TO ANY PRODUCT, AND HIGH END SPECIFICALLY DISCLAIMS ANY WARRANTY OF MERCHANTABILITY OR FITNESS FOR A PARTICULAR PURPOSE. HIGH END SHALL NOT BE LIABLE FOR ANY INDIRECT, INCIDENTAL OR CONSEQUENTIAL DAMAGE, INCLUDING LOST PROFITS, SUSTAINED OR INCURRED IN CONNECTION WITH ANY PRODUCT OR CAUSED BY PRODUCT DEFECTS OR THE PARTIAL OR TOTAL FAILURE OF ANY PRODUCT REGARDLESS OF THE FORM OF ACTION, WHETHER IN CONTRACT, TORT (INCLUDING NEGLIGENCE), STRICT LIABILITY OR OTHERWISE, AND WHETHER OR NOT SUCH DAMAGE WAS FORESEEN OR UNFORESEEN.

Warranty is void if the product is misused, damaged, modified in any way, or for unauthorized repairs or parts. This warranty gives you specific legal rights, and you may also have other rights specific to your locality.

Third Party Software Acknowledgements

AMD: This product uses the Catalyst fgIrx drivers.

Boost: The product include Boost software distributed under the Boost Software License, Version 1.0, http://www.boost.org/LICENSE_1_0.txt.

Botan: This product includes software developed by the Botan Project and its contributors. Copyright © 1999-2005 The Botan Project. All rights reserved.

Libtar: This product includes software developed by the University of Illinois Board of Trustees and Mark D. Roth. Copyright © 1998-2003 University of Illinois Board of Trustees. Copyright © 1998-2003 Mark D. Roth. All rights reserved.

QT: The Qt GUI Toolkit is Copyright (C) 2011 Nokia Corporation and/or its subsidiary(-ies). Contact: Nokia Corporation (qt-info@nokia.com). Qt is available under the LGPL version 2.1 (GNU Lesser General Public License version 2.1).

X11(TM) and X Window System(TM): is a trademark of The XFree86 Project, Inc.

XFree86: is a trademark of The XFree86 Project, Inc.

Xorg: Xorg is copyright software, provided under licenses that permit modification and redistribution in source and binary form without fee. Xorg is copyright by numerous authors and contributors from around the world. Licensing information can be found at <http://www.x.org>. Refer to the source code for specific copyright notices.

Declaration of Conformity

According to ISO/IEC Guide 22 and EN45104

Manufacturer's name: High End Systems
Distributor's name: High End Systems
Distributor's address: 2105 Gracy Farms Lane, Austin TX 78758, USA

Declares that the product:

Product Name: Hog 4
Product Number: All
Product Options: All

Conforms to the following EEC directives:

73/23/EEC, as amended by 93/68/EEC
89/336/EEC, as amended by 92/31/EEC and 93/68/EEC

Equipment referred to in this declaration of conformity was first manufactured in compliance with the following standards in 2002:

Safety: EN60950:2000
EMC: EN55103-1:1996 (E2)
EN55103-2:1996 (E2)

I, the undersigned, hereby declare that the equipment specified above conforms to the above Directives and Standards.



Kenneth Stuart Hansen, Compliance Engineer

30 June 2012

Table of Contents

1: Getting Started	17
1.1 About this Manual	17
1.2 Manual Symbols	18
2: Hog 4 OS Fundamentals	19
2.1 The Command Line	19
2.1.1 Command Line Syntax	19
2.1.2 The Status Bar	21
2.2 The Graphical User Interface	21
2.2.1 Window Management	22
2.3 Abstraction	28
2.3.1 Referring to Fixtures	28
2.3.2 Real World Units	28
2.3.3 Complex Parameters	28
2.3.4 Interchangeable Fixtures	29
2.4 Tracking	29
2.5 HTP and LTP	30
2.6 Colour Matching	30
2.6.1 Colour Models	31
2.6.2 The Colour Matching System	32
2.7 Palettes and Directories	33
2.7.1 Automatic Naming of Directory Items	35
2.7.2 Colour Coding Directory Items	36
2.8 Spreadsheets	37
2.8.1 Compact Mode	39
2.8.2 Aggregation	40
2.8.3 Cut, Copy and Paste	43
2.9 Editors	43
2.9.1 Editor Window Controls	44
2.9.2 Changing Parameter Values in the Editor	45
2.10 Modifier Keys	46
2.11 Undo and Redo	46
2.12 The File Browser	47
2.12.1 Moving, Copying, Deleting and Renaming Files	47
2.12.2 Creating New Folders	48
2.12.3 Ejecting Disks	48
2.12.4 Burning files to CD	48
3: Setting Up the System	51
3.1 Setting Up the Console	51
3.1.1 Starting Up the Console	51
3.1.2 Adjusting the Date and Time	51
3.1.3 Calibrating the Touch Screens	52
3.1.4 Adjusting the Touchscreen LCD Backlight	52
3.1.5 Changing the LCD Backlight Timeout	53
3.1.6 External Touchscreens / Displays	53
3.1.7 Keyboard	55
3.1.8 Trackball	56
3.1.9 Shutting Down and Restarting the Console	56
3.1.10 Locking the Console for Access	57

3.1.11 Mounting Accessories to Hog 4-18	59
3.2 DMX Processor 8000 Setup	59
3.2.1 Setting the Net Number	60
3.2.2 Setting the Port Number	60
3.2.3 Setting IP Addresses for the HogNet Adapter on a DMX Processor 8000	60
3.2.4 Setting the DMX Processor DMX Output Refresh Rate	61
3.2.5 Setting the DMX Processor back to Defaults	61
3.2.6 Locking the DMX Processor Front Panel Controls	61
3.2.7 Backlight Off Time	62
3.2.8 Watchdog	62
3.2.9 Resetting the DMX Processor	62
3.2.10 Checking a DMX Processor's Status	62
3.3 HogNet Network	63
3.3.1 Configuring Console Network Adapters	64
3.3.2 Port Number	68
3.3.3 Node Types and Net Numbers	68
3.3.4 Connecting Multiple Consoles	69
3.3.5 Configuring the Network for Client/Server	69
3.3.6 Configuring the Network for Console Fail over	70
3.3.7 Configuring the Network for Console Tracking	74
3.3.8 More than One Show on the Network	75
3.3.9 Connecting to an Existing Network	76
3.3.10 Network File Sharing	76
3.4 Art-Net and E1.31(sACN)	78
3.4.1 Identifying the FixtureNet Port	78
3.4.2 Configuring the FixtureNet Port	79
3.4.3 Configuring Art-Net Output	80
3.4.4 Configuring E1.31(sACN) Output	80
3.5 Adding Playback Wings	82
3.6 Virtual Playback Wings	84
3.7 High End Systems USB DMX Widgets	86
3.7.1 High End Systems DMX Widget Status LEDs	87
3.8 ETC Gadget II with ETCnomad Key	88
3.8.1 Gadget II Refresh Rates	89
3.8.2 Gadget II Status LED	89
3.9 Hog 4 PC with ETCnomad Key	89
4: Shows	91
4.1 Launch a New Show	91
4.2 Launch an Existing Show	91
4.3 Connect to a Network Show	91
4.4 Change the Currently Loaded Show	92
4.5 Automatically Launch a Show at Console Startup	92
4.6 Managing Show Data	93
4.6.1 Recovering Show Files from a console that won't boot	94
4.7 Startup Comment Macros	94
4.8 Backing Up Your Show	95
4.9 Optimizing Show Files	96
4.10 User Preferences	96
4.10.1 Desklight, Worklight, and Vent Light Preferences	96

4.10.2 Touchscreen Backlight Brightness	97
4.10.3 Trackball and Trackball Ring Preferences	97
4.10.4 Center Wheel Preferences	99
4.10.5 Encoder Wheel Button Options	101
4.10.6 Keys and Button Preferences	101
4.10.7 Importing and Exporting Show Preferences	101
4.11 Merging Shows	102
4.11.1 Merging Fixture Types	103
4.11.2 Merging Fixtures	104
4.11.3 Merging Programming	106
4.11.4 Dependencies	107
4.11.5 How Patching is handled when merging shows	107
4.11.6 Merging Examples	108
4.12 Importing/Exporting Cuelist Data	108
4.12.1 Exporting Cuelist Data to an XML File	108
4.12.2 Importing Cuelist Data from an XML File	108
4.12.3 Importing Cuelist Data from Reaper	109
4.12.4 Importing Cuelist Data from Inqscribe	111
4.13 Importing/Exporting Fixture and Patch Data	112
4.13.1 Exporting Fixture and Patch Data to an XML File	113
4.13.2 Importing Fixture and Patch Data from an XML File	113
4.14 Users	114
4.14.1 Managing Users	114
4.14.2 Chat	115
5: Adding, Patching, and Managing Fixtures	117
5.1 Adding Fixtures	117
5.2 Assigning User Numbers to Fixtures	118
5.3 Assigning Dotted User Numbers to Fixtures	119
5.4 Compound Fixtures	121
5.4.1 Compound Fixture Explode	121
5.5 Fixture Aggregation	121
5.6 Patching Fixtures	122
5.6.1 Patching DMX Protocol Fixtures	123
5.6.2 Patching Video Protocol Fixtures	133
5.7 Replicating Fixtures	134
5.8 Changing the Fixture Type	135
5.9 Removing a Fixture from the Show	136
5.10 Creating Palettes and Groups Automatically	136
5.11 Configuring Fixtures	138
5.11.1 Fixture Configuration	138
5.11.2 Parameter Configuration	141
5.12 Auto-Patch	145
6: Selecting Fixtures and Modifying Parameters	147
6.1 Selecting Fixtures	147
6.1.1 Selecting Single Fixtures	147
6.1.2 Selecting Multiple Fixtures	148
6.1.3 Selecting fixtures with dotted user numbers	148
6.1.4 Select All	153
6.1.5 Inverting the Selection	153
6.1.6 Sub Selections	153

6.1.7 Lateral Selections	154
6.1.8 Deselecting Fixtures	155
6.1.9 Reselecting Fixtures	155
6.2 Selection Order	156
6.2.1 Reverse, Shuffle and Reorder	156
6.3 Modifying Parameters	156
6.3.1 Intensity	157
6.3.2 Position	159
6.3.3 Continuous Parameters: Colour and Beam	160
6.3.4 Slotted Parameters: Colour and Beam	161
6.3.5 Working with Colour	162
6.3.6 Fine Control	166
6.3.7 Touching Parameters	166
6.3.8 Copying Parameter Settings	168
6.3.9 Restoring Default Values	170
6.4 Fanning	170
6.4.1 Using the Fan Key	171
6.4.2 In the Programmer Window	171
6.4.3 With the Command Line	171
6.4.4 Fanning Options	172
6.4.5 Multi-part Fanning	173
6.4.6 Fanning with Segments and Buddying	173
6.5 Removing Values	175
6.5.1 Removing Entire Fixtures from an Editor	175
6.5.2 Removing Kinds from an Editor	175
6.5.3 Removing Individual Parameters from an Editor	175
6.6 Separating Parameters	176
7: Groups	177
7.1 Auto-Generating Groups	177
7.2 Recording Groups	177
7.3 Naming Groups	178
7.4 Using Groups in Programming	178
7.5 Editing Group Contents	178
7.5.1 Removing Fixtures from Groups	178
7.6 Deleting Groups	179
7.7 Copying and Moving Groups	180
7.8 Insert, Merge and Replace	180
8: Palettes	181
8.1 Recording a Palette	181
8.1.1 Naming a Palette	181
8.2 Using Palettes in Programming	182
8.3 Editing Palette Contents	182
8.3.1 Updating Palettes with Different Parameter Types	183
8.4 Deleting Palettes	184
8.5 Copying and Moving Palettes	184
8.6 Record Options	185
8.6.1 Global, Per Fixture Type, and Per Fixture	185
8.6.2 Recording Palettes with Kind Masking	187
8.6.3 Palette Timing	189
8.6.4 Reference Palettes	190

8.6.5 Direct Palettes	190
8.7 Insert, Merge and Replace	191
9: Directory Windows	193
9.1 Types of Directories	193
9.2 Mask (IPBCE Palette Directories Only)	193
9.3 Color Coding	194
9.3.1 Coloring the entire button	195
9.4 Button Sizes	196
9.5 Show Fewer Buttons	197
9.6 Buttons Across Option	198
9.7 Show Auto Color Swatch	199
9.8 Spreadsheet View	200
10: Media Picker	203
10.1 Media Picker Overview	203
10.2 Media Picker Window Options	203
10.3 CITP Previews in the Media Picker	204
10.3.1 Supported CITP Media Server Clients	205
10.3.2 Configuring DP8000 for CITP Discovery	205
10.3.3 Patching fixtures to CITP discovered fixtures	206
10.3.4 Refreshing CITP Previews	206
10.3.5 Disabling CITP on DP8000	207
10.4 Catalyst Previews in the Media Picker	207
10.4.1 Configuring DP8000 for Catalyst Previews	207
10.4.2 Patching Catalyst fixtures to Catalyst Media Servers	207
10.4.3 Refreshing Catalyst Previews	208
10.4.4 Disabling Catalyst Preview Fetching on DP8000	208
10.5 Adding Previews to Pre-v2.0.0 Show Files	209
10.6 Renaming & Customizing Preview Images	209
10.7 Managing Preview Packages	210
11: Cues and Cuelists	213
11.1 Recording a Cue	213
11.1.1 Recording to a Cuelist on a Master	213
11.1.2 Programmer contents after Recording a Cue	213
11.1.3 Insert, Merge and Replace	214
11.1.4 Numbering Cues	214
11.1.5 Naming Cues	214
11.2 Record Options	215
11.2.1 Recording Selected Fixtures Only	215
11.2.2 Record, Remove Values from Cues	215
11.3 Deleting Cues	215
11.4 Copying and Moving Cues	216
11.4.1 Copying Cues	216
11.4.2 Moving Cues	217
11.5 Renumbering Cues within a Cuelist	217
11.6 Editing Cue Contents	218
11.6.1 Viewing Different Cues in the Editor	219
11.7 Working with Tracking	219
11.7.1 Tracking Values Backwards When Recording	219
11.7.2 Stopping Values from Tracking Forward	220
11.7.3 Deleting without Tracking Forward	222

11.7.4 Blocking Cues	222
11.7.5 Unblocking	223
11.8 Mark Cues (Move in Black)	224
11.8.1 How to Mark to a Cue	225
11.8.2 Fade Mark versus Time Marks	226
11.8.3 Marking the First Cue in a Cue List	227
11.8.4 Cuelist Feedback for Mark Cues	227
11.9 Understanding Cuelists	228
11.10 Naming Cuelists	229
11.11 Deleting Cuelists	229
11.12 Copying and Moving Cuelists	230
11.12.1 Copying Cuelists	230
11.12.2 Moving Cuelists	230
11.12.3 Insert, Merge and Replace	231
12: Scenes	233
12.1 Recording Scenes	233
12.1.1 Recording to the Scene Directory	233
12.1.2 Recording to a Physical Master	233
12.1.3 Naming a Scene	233
12.2 Deleting Scenes	234
12.3 Copying and Moving Scenes	234
12.4 Editing Scene Contents	235
12.5 Scene Timing	235
12.6 Insert, Merge and Replace	235
12.7 Toggling Scenes On/Off in Playback	236
13: Timing	237
13.1 Timing Basics	237
13.2 Fade, Delay, and Path	238
13.2.1 Fade Time	238
13.2.2 Delay Time	240
13.2.3 Paths	240
13.2.4 Assigning Cue Timings in the Cuelist Window	241
13.3 Individual Parameter Timings	243
13.3.1 Assign Parameter Timings using Wheels	244
13.3.2 Assign Parameter Timings with the Command Line	245
13.3.3 Assign Parameter Timings in an Editor	246
13.3.4 Fanned Timings	248
13.4 Cue Wait Timing	249
13.4.1 Learn Timing	250
13.4.2 Clock Triggers	251
13.5 Loops and Links	254
13.5.1 Creating a Link	254
13.5.2 Creating a Loop	254
13.5.3 Tracking Through Loops	256
14: Effects	257
14.1 Table Effects	257
14.1.1 Effect Tables	257
14.1.2 Table Effect Attributes	258
14.1.3 Building Table Effects in the Effects Engine	261
14.1.4 Building Table Effects in Editors	263

14.1.5 Effect Spread	264
14.1.6 Building Table Effects using Palettes	264
14.1.7 Tracking Table Effects	264
14.1.8 Cue Timing and Table Effects	265
14.2 Effect Palettes	266
14.2.1 Predefined Effect Palettes	266
14.2.2 Adjusting Predefined Effects	267
14.2.3 Recording an Effect Palette	267
14.2.4 Using Effect Palettes in Programming	268
14.2.5 Editing Effect Palettes	269
14.2.6 Deleting Effect Palettes	269
14.2.7 Copying and Moving Effect Palettes	269
15: Kinds and Wheelsets	271
15.1 Kinds	271
15.1.1 Fixed Kinds	271
15.1.2 User Kinds	271
15.2 Wheelsets	274
16: Advanced Programming	277
16.1 Selecting from What is Onstage	277
16.2 Bringing Parameter Values Into the Programmer	278
16.2.1 Suck	278
16.2.2 Using Live and Touch	279
16.2.3 Using Copy to Bring Values into an Editor	281
16.3 Highlight and Lowlight	281
16.3.1 Customising Highlight	282
16.3.2 Lowlight	283
16.4 Auto Update	283
16.5 Editing Discreetly	285
16.5.1 Fade Changes	285
16.5.2 Blind	285
16.6 Parking	286
16.6.1 Viewing and Editing What is Parked	286
17: Playback	289
17.1 Physical Master Playback	289
17.1.1 Attaching Cuelists, Scenes, and Batches to Physical Masters	289
17.1.2 Moving and Copying between Physical Masters	289
17.1.3 Detaching from a Physical Master	290
17.1.4 Configuring Physical Master Playback Controls	290
17.1.5 Playback Commands	293
17.2 Virtual Master Playback	297
17.2.1 Running Cuelists, Scenes, and Batches from the Directory Windows	297
17.2.2 Using the Play Controls Toolbar to Play a Cuelist, Scene, or Batch	298
17.2.3 Running Virtual Masters from the Command Line	299
17.3 Choosing and Selecting Masters	299
17.4 Releasing Masters	300
17.4.1 Release Time	300
17.4.2 Auto Release	301

17.4.3	Resetting Cuelists on Release	302
17.4.4	Releasing on Another Go	303
17.5	Master Playback Options	303
17.5.1	Master Timing and Rate Settings	304
17.5.2	Cuelist Wrapping	305
17.5.3	Cue Only	306
17.5.4	Action of go when Looping	306
17.5.5	Action of Halt when Halted	306
17.6	Latest Take Precedence (LTP)	307
17.6.1	Asserting One Cuelist Over the Others	307
17.6.2	Multiple Cuelists with Effects	308
17.6.3	Changing a Cuelist's Priority	309
17.7	Highest Takes Precedence (HTP)	311
17.8	Understanding Feedback	312
17.8.1	Control and Playback Toolbar Feedback	312
17.8.2	Cuelist Feedback	314
17.8.3	The Output Window	315
17.8.4	The Levels View Window	317
17.9	Advanced Playback	319
17.9.1	Adjusting the Playback and Effect Rates of a Master	319
17.9.2	Adjusting the Effect Size of a Master	320
17.9.3	Manually Cross-fading Cuelists	321
17.9.4	IPCB Faders	322
17.9.5	Using a Cuelist as a Chase	323
17.9.6	Cuelists and Tracking	326
17.9.7	Triggering Automatic Tasks When a Cue Runs	326
17.9.8	Playback Masking	327
17.10	Grand Master	327
17.10.1	GM Key	327
17.10.2	DBO Key	328
17.10.3	Flash key below the Grand Master	329
17.11	Group Masters	329
17.12	Batches	331
17.12.1	Creating Batches	331
17.12.2	Modifying Batch Contents	332
17.12.3	Using Batches	332
17.12.4	Capturing	333
17.12.5	Batch Master LED Feedback	333
17.12.6	Batch Master Playback Bar Feedback	333
18: Pages	335
18.1	How Pages Are Used	335
18.2	Creating a New Page	335
18.3	Changing Page	336
18.3.1	Options When Changing Page	336
18.3.2	Matching Levels When Changing Page	338
18.3.3	Restoring Activity When Changing Pages	338
18.4	Modifying Pages	339
18.4.1	Copying Lists, Scenes and Group Masters to a Page	340
18.4.2	Moving Lists, Scenes and Group Masters to a Page	340

18.4.3 Removing Lists, Scenes and Group Masters from a Page	340
18.4.4 Clearing Lists, Scenes and Group Masters from a Page	341
18.5 Copying and Moving Pages	341
18.6 Deleting Pages	341
18.7 The Template Page	342
19: Command Keys	345
19.1 Command Key Overview	345
19.2 Creating Command Keys	345
19.3 Copying, Moving, and Deleting Command Keys	346
19.4 Changing the Action of a Command Key	346
19.5 Command Key Feedback	347
20: Plots	349
20.1 Introduction to Plots	349
20.2 Creating Plots	350
20.3 Editing Plots	351
20.3.1 Fixtures	351
20.3.2 Gangs	352
20.3.3 PixelMaps	353
20.3.4 Background Images	354
20.3.5 Tips for editing multiple plot objects	357
20.4 Using Plots	358
20.4.1 Fixture Selection	358
20.4.2 Navigation (zoom/scroll)	359
20.4.3 Feedback	359
20.4.4 Show/Hide Fixture Numbers	360
20.4.5 Exporting Plots	360
20.5 PixelMapping	360
20.5.1 PixelMap Layers	360
20.5.2 Programming lighting fixtures to use PixelMaps	361
20.5.3 Programming PixelMap Layers	362
20.5.4 PixelMap Layer Effects	362
20.5.5 Managing PixelMap Layer Content	363
21: MIDI	367
21.1 MIDI Show Control	367
21.1.1 Bringing MSC into the Console	367
21.1.2 Sending MSC from the Console	368
21.1.3 Using MIDI Show Control	369
21.2 MIDI Note Input	369
21.2.1 Assigning MIDI Note Input to Playback Bars	370
21.2.2 Assigning MIDI Note Input to Programming Keys	371
21.2.3 Assigning MIDI Notes Input to Encoders and Wheels	372
21.2.4 Assigning MIDI Note Input to Monitor Soft Keys	373
21.2.5 Assigning MIDI Note Input to Comment Macros	374
21.2.6 Using Midi Note Controller Messages to Control Faders	375
21.3 MIDI Note Output	376
21.4 MIDI timecode	378
21.4.1 Connecting Midi Timecode Input	378

21.4.2	Viewing Incoming MIDI Timecode	378
21.4.3	Triggering Cues from MIDI Timecode	379
21.4.4	Editing Timecode Values	380
21.4.5	Simulating MIDI Timecode	380
22:	Open Sound Control	383
22.1	Introduction to OSC	383
22.2	Configuring OSC Input	383
22.3	Configuring OSC Output	384
22.4	OSC Mappings	385
22.4.1	OSC Playback Mappings	385
22.4.2	OSC Midi Note Mappings	386
22.4.3	OSC Hardware Mappings	386
22.4.4	OSC Status Mappings	389
22.5	OSC over WiFi	390
23:	Linear Timecode (LTC)	393
23.1	LTC Input into Console	393
23.2	LTC Input into a DMX Processor 8000	394
23.3	Viewing Incoming LTC	395
23.4	Triggering Cues from LTC	396
23.5	Editing Timecode Values for a Cue	397
23.6	Simulating LTC	397
24:	Macros	399
24.1	Intro to Macros	399
24.2	Comment Macros	399
24.2.1	Entering Comment Macro Commands	402
24.2.2	Additional Comment Macro Syntax	403
24.3	Keystroke Macros	403
24.3.1	Recording Keystroke Macros	404
24.3.2	Naming Keystroke Macros	405
24.3.3	Keystroke Macro Playback	405
24.3.4	Editing Keystroke Macros	408
24.3.5	Deleting Keystroke Macros	409
24.3.6	Copying and Moving Keystroke Macros	410
25:	Direct Control of DMX Channels	413
25.1	The DMX Output Window	413
25.2	Manually specifying DMX Channel Values	413
25.3	Setting DMX Channels to External Art-Net Source	414
25.4	Reverting DMX Channels to HogNet Control	414
25.5	DMX Test	415
26:	Reporting	417
26.1	Creating, Running, and Managing Report Queries	417
26.2	Organizing and Saving Report Results	418
26.3	Using Report Results to Edit Programming	418
27:	Fixture Library	419
27.1	Introduction	419
27.2	Download and Install Fixture Libraries	419
27.3	Request Fixture Types from High End Systems	420
27.4	Build Fixture Types using Fixture Builder	420
27.4.1	Creating a Fixture Type from Scratch	420
27.4.2	Creating a Fixture Type from an Existing Type	421

27.4.3 Fixture Builder Basic View	421
27.4.4 Fixture Builder Advanced View	424
27.4.5 Fixture Builder Functions Tab	425
27.4.6 Building a Fixture Type	426
27.4.7 Exporting Fixture Types to a Library	426
27.4.8 Exporting Fixture Types to XML	427
27.4.9 Importing Fixture Types from XML	427
27.4.10 Fixture Builder Terminology	427
27.4.11 Fixture Builder Practice Tutorial	429
28: Visualizer Connectivity	437
28.1 Connectivity Overview	437
28.2 Installing the Hog Connectivity Driver on the Visualizer PC	437
28.3 Physically Connecting the Console to the Visualizer	440
28.4 Configuring the Visualizer PC for Connectivity	440
28.4.1 Network Settings on the Visualizer PC	440
28.4.2 WYSIWYG Configuration	441
28.4.3 WYSIWYG Console Edition Configuration	444
28.4.4 Vectorworks Vision Configuration	445
28.4.5 Capture Configuration	446
28.5 Configuring the Console for Visualizer Connectivity	446
28.5.1 Enabling the Visualizer Stream on the Console	446
28.5.2 Configuring a Show for Visualizer Connectivity	447
28.6 Autofocus	449
28.7 Visualizer Troubleshooting	449
29: Updating Software	451
29.1 Console Software Update	451
29.2 Console Software Full Install	452
29.3 Create a Full Install USB Flash Drive (Hog 4 OS v3.9.0 and newer)	454
29.4 Create a Full Install USB Flash Drive (Hog 4 OS v3.8.0 and older)	455
29.5 DMX Processor Software Update	456
29.6 DMX Processor Software Full Install	457
29.7 Upgrading HedgeHog 4 Consoles (2015 and later)	459
29.8 Upgrading Hog 2 USB DMX Widgets	463
30: Hog 4 PC	467
30.1 Software Installation	467
30.2 Software Removal	470
30.3 Operation	471
30.3.1 Using the Hog 4 PC Interface	471
31: Cheat Sheets	473
31.1 QWERTY Keyboard Shortcuts	473
31.2 Hog 4 OS Key Combinations	475
31.3 DMX Processor 8000 Front Panel Button Combinations	478
31.4 Front Panel Diagrams	479
31.5 Decimal to Hex Conversion Chart	480
32: Troubleshooting	481
32.1 Console won't startup	481
32.2 No DMX Output from Console's built-in DMX Outputs	481
32.3 No ArtNet Output from console's FixtureNet Port	482

32.4	The console appears to have crashed or frozen	483
32.5	Console isn't talking to DMX Processors	483
32.6	Playback controls don't behave as expected	483
32.7	ETCnomad Key not recognized by Hog 4 PC	484
32.8	The Front Panel Reboots Unexpectedly	484
32.9	How to Report Problems to Support	484
32.9.1	Reporting Problems with the Console	485
32.9.2	Reporting Problems with Hog 4 PC	485
32.9.3	Reporting Problems with the User Manual	486
32.9.4	About Software Version Numbering	486
33:	Service	487
33.1	Replacing the Screens	487
33.2	Replacing Faders	487
33.2.1	Replacing faders on Hog 4, Full Boar 4, and Playback Wing 4	488
33.2.2	Replacing faders on Road Hog 4 and Nano Hog 4	488
33.3	Cleaning Faders	488
33.3.1	Cleaning faders on Hog 4, Full Boar 4, and Playback Wing 4	489
33.3.2	Cleaning faders on Road Hog 4 and Nano Hog 4	489
33.3.3	Cleaning faders on HedgeHog 4	489
33.4	Replacing the Trackball	490
34:	Safety Information	491
34.1	Safety Warnings	491
34.1.1	For Continued Protection Against Fire	491
34.1.2	For Continued Protection Against Electric Shock	491
34.2	Informations Importantes Sur La Sécurité	492
34.2.1	Pour Une Protection Permanente Contre Les Incendies	492
34.2.2	Pour Une Protection Permanente Contre Les Chocs Électriques	492
34.3	Wichtige Hinweise Für Ihre Sicherheit	492
34.3.1	Zum Schutz Vor Brandgefahr	492
34.3.2	Zum Schutz Gegen Gefährliche Körperströme	492
34.4	Información Importante De Seguridad	493
34.4.1	Para Protección Continua Contra Incendios	493
34.4.2	Para La Protección Continua Contra Electro- cuciones	493
34.5	Importanti Informazioni Di Sicurezza	494
34.5.1	Per Prevenire Incendi	494
34.5.2	Per Prevenire Le Scosse Elettriche	494
34.6	Vigtig Sikkerhedsinformation	494
34.7	安全に関する情報	495
34.7.1	警告: 火災からの継続的な保護の為に	495
34.7.2	警告: 感電に対する継続的な保護の為に	495
35:	Technical Specifications	497
35.1	Hog 4 Console	497
35.1.1	Input and Output Connections	497
35.1.2	Power, Weight and Dimensions	497
35.2	Hog 4-18 Console	498

35.2.1 Input and Output Connections	498
35.2.2 Power, Weight and Dimensions	498
35.3 Full Boar 4 Console	499
35.3.1 Input and Output Connections	499
35.3.2 Power, Weight and Dimensions	499
35.4 Road Hog 4 Console	500
35.4.1 Input and Output Connections	500
35.4.2 Power, Weight and Dimensions	500
35.5 HedgeHog 4 Console	501
35.5.1 Input and Output Connections	501
35.5.2 Power, Weight and Dimensions	501
35.6 HedgeHog 4 Console (Jan 2015 and later)	502
35.6.1 Input and Output Connections	502
35.6.2 Power, Weight and Dimensions	502
35.7 Nano Hog 4 Console	503
35.7.1 Input and Output Connections	503
35.7.2 Power, Weight and Dimensions	503
35.8 DMX Processor 8000	504
35.8.1 Input and Output Connections	504
35.8.2 Power, Weight and Dimensions	504
35.9 Playback Wing 4	505
35.9.1 Input and Output Connections	505
35.9.2 Power, Weight and Dimensions	505
35.9.3 Performance	505
35.10 Master Wing 4	506
35.10.1 Input and Output Connections	506
35.10.2 Power, Weight and Dimensions	506
35.10.3 Performance	506
35.11 Hog 4 PC	507
Glossary	509
Index	521

Section 1: Getting Started

1.1 About this Manual

This manual describes the Hog 4 OS as it pertains to the Hog 4 range of consoles (Hog 4-18, Hog 4, Full Boar 4, Road Hog 4, HedgeHog 4, Nano Hog 4, Rack Hog 4, and Hog 4 PC).

Some of the information contained in this manual will only apply to specific consoles in the Hog 4 family but that information will be clearly identified as console specific.

In this manual the word 'key' is used to indicate a hardware button on the console's front panel. For example: 'press the Enter key'. The word 'button', when used in this manual, refers to 'virtual' buttons that can be pressed on the touch screens or clicked on with the Trackball or mouse.

This manual can be read in any order but if you haven't used a Hog 4 console before you may want to start with the *Hog 4 OS Fundamentals (p.19)*

You can open your console's built in User Manual at any time by pressing the Help button on the Window Control Toolbar, at the top of the right-hand screen.

1.2 Manual Symbols

The following formatting conventions are used in the text of this manual:

XXXX - text that is italicized and underlined indicates a reference to a term in the glossary.

XXXX - dark red text indicates the name of an interface element such as a button, key, or window.

(XXXX) - dark red text inside a set of brackets indicates a button that has a label specific to the show that is created by the console or the user.

XXXX - dark blue text indicates information that you should literally input into the Hog 4 OS verbatim.

[**XXXX**] - dark blue text inside a set of brackets indicates the manual is only describing the type of information that you should input into the Hog 4OS.

XXXX, XXXX, XXXX- dark red text separated by commas indicates key or button presses that are sequential.

XXXX + XXXX - dark red text followed by + indicates a key or button press that is held down while the second key or button is pressed.

XXXX → XXXX → XXXX - dark red text mixed with arrows indicates a sequence of operations that navigate you through windows and toolbars.

You will also find important or useful information highlighted:



Caution

Information regarding potential hazards to the equipment or your personnel.



Important

Information regarding items require special attention.



Tip

Information to help you be more productive in your programming.

Section 2: Hog 4 OS Fundamentals

2.1 The Command Line

The majority of user input into Hog 4 OS is handled through the command line. Keystrokes and button presses accumulate on the Command Line Toolbar where users build executable commands such as recording a cue. In some cases command line input is executed immediately but in most cases you must press Enter to confirm that the command is complete. To remove any unwanted keystrokes from the command line press the Backspace key once. To completely clear the command line double-press the Backspace key.

2.1.1 Command Line Syntax

The basic order and structure of the Hog 4 OS command line syntax is: Source, Mask, Command, Options, Destination.

- **Source:** The source is the object within the show that you want to take data from. It might be a palette, scene, cue, or the editable editor. With most commands the source object is not modified.
- **Mask:** The Mask is a filter for when you only want some of the data from that object. There are two types of mask: a fixture mask specifies only data for certain fixtures (for example Cyberlight 1); a kind mask specifies only data for certain kinds (for example Colour, Beam). If no mask is specified then the entire contents of the current active editor are included in the command.
- **Command:** The Command is the operation you want to perform. Commands include Copy, Record, Delete, Move, Merge, Knockout. Some of these only need a source to be specified, others only need a destination, but they all have the same syntactical form.
- **Options:** The behaviour of some commands (for example Record) can be altered with options. These usually appear on a pop-up toolbar once the command key is pressed.
- **Destination:** The destination is the object that will be affected by the command. Again it might be a palette, cue, scene or the editable editor. If the destination already exists, and the action to take is unclear, then you will be asked what the console should do.

Some examples of command line syntax are shown in the table below. Note that a final press of the Enter key is required to tell the console to the command is complete and ready to be executed. If the the command line text turns red then the syntax is invalid.





Source	Mask	Command	Options	Destination	Comments
		Record		Position 1	Records a position palette to location 1 in the position palette directory. No source is given, so the content of the current editor is assumed.
		Record	Replace	Position 1	The Replace option (on the Record Options Toolbar) ensures that the new palette replaces the previously recorded palette.
Position 1		Copy		Position 2	The Copy command takes the Position 1 palette as its source.
Position 1		Copy	Replace	Position 2	This example combines using a source and a record option.
Group 2		Record		Position 3	Here Group 2 acts as a mask for the record command, so that only fixtures in Group 2 are recorded into the Position 3 palette.
Cue 1 Group 3	Position	Copy		Cue 5	Here the parameter values of fixtures in Group 3 are copied from Cue 1 to Cue 5. The Position option applied to the copy command means that only position parameters are included.

2.1.2 The Status Bar

To the right of the command line is the Status Bar which provides basic information about the status of the console as well as connected network items.



The table below describes many of the different items shown on the Status Bar:

Description	Examples
Function Key Mode	CMD (command key mode) KIND (kind key mode)
Kind Masking Mode	ADD (additive) SUB (subtractive)
Chat Status	Click on chat icon to open the chat window.
Trackball mode	--- (pointer mode) POS (position mode) POS, ortho (position ortho mode)
Keyboard Mode	Abc (normal mode) MAP (keyboard shortcuts enabled)
Name of the current page	Page 1 (click on this area to open page directory)
Current editor	Programmer
Currently chosen master	Master 10
Network status	 - Network is stable  - Data is syncing across consoles  - DP on network needs software upgrade  - Network Fault, check connections
Local console time (Hour:Minute)	16:28

2.2 The Graphical User Interface

In addition to the conventional command line, the Hog 4 OS uses a **graphical user interface** similar to those found on personal computers. The advantages of the graphical user interface are far-reaching, and will become fully apparent as you get more familiar with Hog 4 OS.

Key features of the GUI are:

- You can work with on-screen controls and windows using the touch screen or through a pointer controlled by the built in Trackball, or an external mouse. Left-clicking the mouse is the same as touching the screen and is used for selecting or activating controls, while right-clicking brings up a context-sensitive range of menu options.
- The Soft Keys adjacent to the touch screens provide another method of accessing functions, changing to match whichever **toolbar** is docked along that edge of the screen.
- The graphical environment is highly customisable, giving you complete control of the console and individual window layout. For example, you can rearrange column headers in list windows (e.g. the Cuelist and Programmer windows) to prioritise information that is most pertinent to a specific show or user. Information displayed can also be sorted or filtered. When a user logs out these preferences and settings are stored, and retrieved again on logging in.

2.2.1 Window Management

Opening Windows

Windows can be opened in five ways:

- **Press and hold on the touchscreen:** Press and hold on any empty section of the touchscreen (double click also works); this will bring up a menu window which contains button options for converting the menu window into a system window such as the programmer or output window. The initial size of the menu window depends on where you press the screen. For example, pressing and holding in one of the four corners of the screen will open a quarter sized menu window while pressing and holding in the middle of the screen close to the Hog 4 logo will open a menu window that is full screen.
- **From a Toolbar:** Some windows may have a dedicated button that can be pressed; the Programmer, for example.
- **With the Open Key:** To open a window using console keys, hold down Open and press the window's associated key or button. For example:
 - Open + Position : opens the Position Directory window.
 - Open + List : opens the Cuelist Directory window.
 - Open + Choose : opens the Cuelist window for the chosen master.

You can also hold down the Open key to gain access the second level of the main toolbar with buttons for many of the console's windows, such as the Output and Parked windows.

- **From the Command Line:** You can specify the window to be opened using the command line, and then press the Open key. For example:
 - Position 5 Open : opens the editor window for Position Palette 5.
 - Cue 4 / 8 Open : opens the editor window for Cue 8 in the cuelist on Master 4.
- **Double Pressing Keys:** You can also open some windows by double-pressing the appropriate key:
 - Position, Position : opens the Position Directory window.



Tip

If you prefer not to use the double-press shortcut to open windows, then assign the double-press time to zero to disable it: see *Keys and Button Preferences* (p. 101).

Closing Windows

Windows can be closed using the



button located at the top right of the window. Windows can also be closed by pressing Open + Backspace.

Window Control

The Window Control Toolbar is located at the top of the right-hand touch screen and provides a quick and easy way to manipulate windows. Its functions are also available as keyboard shortcuts.

Button	Function	Shortcut
	Page Up, Page Down, Page Left and Page Right scroll the currently selected window. The cursor isn't moved.	
	Copy creates a copy of the selected window. This is helpful when you need to view two parts of the same window at once.	Open + (/)
	Size rotates through a range of set positions and sizes for the selected window within its current screen. The options are full screen, and top, bottom, left and right half and quarter screens. Holding down the Pig key while pressing Size rotates through the options in the reverse order.	Open + (+) or (-)
	Move Screen moves the selected window between touch-screens and external displays.	Open + @
	Maximise toggles the size of the currently selected window between full screen and its previous size.	Open + Full
	Focus switches between windows in turn, bringing each to the front.	Open + Thru
	The unlock button allows the positions and sizes of all windows to be changed by the Trackball or mouse (but not the toolbar buttons). Windows are unlocked when this button is enabled.	Open + .
	Close closes the front-most window.	Open + Backspace

Using the Mouse or Trackball

To move a window, click and hold on the window's top status bar whilst dragging it to its new position. To move a toolbar click and hold its left-hand edge and drag to its new position.

Windows can be resized by clicking and holding on corners until the resize arrow appears. You can then drag the corner to make the window bigger or smaller.

Note that you can only use the mouse or Trackball to move and resize windows if you



have unlocked them with the Lock button on the window control toolbar. Keeping the windows locked is useful when using the touch screens, so that you do not accidentally drag or resize windows with their title bars or borders. You can still move and resize windows with the buttons on the toolbar.

Scrolling Window Contents

When a window's contents is too great to fit inside the window, scroll bars appear along the right and bottom edges of the window. You can scroll by pressing or clicking and then dragging on the scroll bar's slider, or by pressing or clicking on the arrows at the ends of the scroll bar.

In addition, you can scroll window contents by holding down the Open key and using the Trackball, I-Wheel or parameter wheels to scroll.

Desktop Views



Figure 2.1. The View Toolbar

Desktop views allow you to store arrangements of windows for quick access so you do not have to re-open and re-arrange windows to perform specific tasks. For example, you could create a programming view that shows the group, palette and effects directories along with the Programmer window. A playback view could display the cuelist and scene directories, and the Output window.

Desktop views are managed by the View Toolbar at the top of the left-hand touch screen (see Figure 2.1, "The View Toolbar") and the Views Directory (see Figure 2.2, "The Views Directory"). You can open the Views Directory by holding down the Open key and pressing the View button on the View Toolbar.

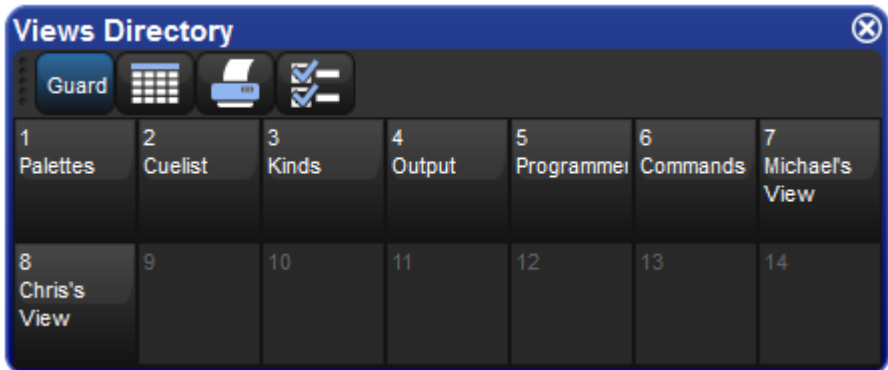

Figure 2.2. The Views Directory



Tip

When you create a new show, it automatically contains desktop views for palettes, cuelists, output and the Programmer.

Recording a Desktop View

To record a desktop view using the View Toolbar:

1. Arrange the console's windows as you want them stored in the desktop view.
2. Hold down the Record key and press one of the numbered buttons on the View Toolbar.

Naming a Desktop View

To name a desktop view using the View Toolbar:

1. Press the Set key together with the appropriate button on the View Toolbar. The Quickname window will open.
2. Enter a name, and click on OK.

To name a desktop view using the Views Directory:

1. Open + View : opens the Views Directory.
2. Select the button for the view you want to name. Make sure that the Guard button is depressed, otherwise you will activate the view instead of just selecting it.
3. Press the Set key. The Quickname window will open.
4. Enter a name, and click on OK.



Tip

You can also assign view names, and add comments to them, in the spreadsheet view of the Views Directory. See *Desktop View Options (p.27)*.

Recalling a Desktop View

You can recall desktop views in two ways:

- **With the View Toolbar:** located at the top of the left hand screen. The views each have their own button, and are loaded in pages of ten onto the toolbar. You can load the next page by pressing the Next button at the right hand end of the toolbar, while Pig + Next loads the previous page.
- **With the Views Directory window:** press the view's button in the Views Directory window. Make sure that the Guard button is not depressed, otherwise you will only select the view, rather than activating it.

Desktop View Options

By default, when you recall one desktop view it replaces the previous one, so that all windows not part of the new view are closed. However, you can set views so that they are additive instead:

1. Open + View : opens the Views Directory.
2. Select the directory's spreadsheet view.
3. Select the view's cell in the Additive column.
4. Press the Set key to toggle between Yes and No.

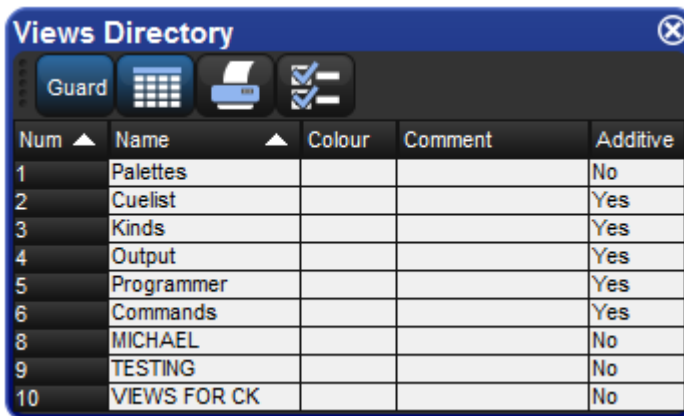

Num ▲	Name ▲	Colour	Comment	Additive
1	Palettes			No
2	Cuelist			Yes
3	Kinds			Yes
4	Output			Yes
5	Programmer			Yes
6	Commands			Yes
8	MICHAEL			No
9	TESTING			No
10	VEWS FOR CK			No

Figure 2.3. The Views Directory in Spreadsheet View

Deleting a Desktop View

To delete a desktop view using the View Toolbar:

1. Hold down the Delete key and press the appropriate button on the View Toolbar.
2. Press OK to confirm.

To delete a view using the Views Directory:

1. Open + View : opens the Views Directory.
2. Check that the directory's Guard button is depressed, so that you can select buttons within the directory without activating them.
3. Press the appropriate directory button and then the Delete key.
4. Click OK to confirm the delete.

**Tip**

If you prefer not to be asked to confirm the delete action, select Don't Ask Me Again in the confirmation window. You can re-enable the confirmation by going to Setup → Preferences → Programming and selecting Confirm before deleting directory items.

2.3 Abstraction

A key advantage to the Hog 4 OS is that you don't have to worry about the technicalities of how each lighting manufacturer implements the features of their lighting fixtures because the Hog 4 OS acts as a layer between you and the lighting hardware, automatically converting 'abstract' ideas of intensity, colour, and so on into the specific instructions that the fixtures need, defined by their DMX protocol.

2.3.1 Referring to Fixtures

The Hog 4 OS treats every fixture as a single entity. Every fixture is assigned a user number that allows users to easily recall a fixture and manipulate its feature set no matter how many parameters it has. For more information on giving your fixtures custom user numbers, see *Assigning User Numbers to Fixtures (p.118)*.

Hog 4 OS treats conventional lights, consisting of a luminaire controlled by a dimmer, as a special kind of fixture known as a 'desk channel'. A desk channel has only one parameter: intensity.

2.3.2 Real World Units

Fixture parameters are described as far as possible in real world units. For example, rotation is described in degrees while chases are described in beat per minute. This speeds up programming and allows fixtures of different types to be selected and adjusted at the same time: for example, you can assign several fixtures of different types to all strobe at 10 Hz without having to worry about the different DMX values required by each fixture to achieve this. Hog 4 OS will give you the best possible match between fixtures; the only limitations are those of the fixtures themselves.

2.3.3 Complex Parameters

Some fixtures put more than one parameter onto a single DMX address. For example, a fixture might use DMX values in the range 0-127 for intensity, 128-250 for strobe, and 251-255 for fixture reset. The Hog 4 OS separates such functions into independent parameters, so that you do not need to remember the detailed workings of a particular fixture; in the example given above, the intensity, strobe and reset functions all appear as separate parameters, so there is no possibility of going from strobe into reset. With parameters that share a DMX address, changing the value of one will override the value

of all the others, since there can only be one DMX value. In the case of our example, assigning a strobe speed will override any intensity value; the console will show a ~ in place of the intensity value to indicate that this has happened.

2.3.4 Interchangeable Fixtures

Any fixture already programmed into a show can be replaced by a fixture of a different type at any time and Hog 4 OS will as far as possible convert the programmed data to apply to the new fixture type. If the new fixture has more limited capabilities than the old one, this is handled as gracefully as possible. For more on replacing fixtures, see *Changing the Fixture Type* (p.135).

2.4 Tracking

All Hog 4 family consoles are tracking by default which means the Hog 4 OS records only changed cue data into cues and scenes allowing unchanged data that was recorded in previous cues and scenes to track through until a change is recorded for that particular fixture parameter.

Below is an example of how a series of cues might be seen by a viewing audience:

Fixture:	A	B	C
Cue 1	100	50	100
Cue 2	100	25	50
Cue 3	100	75	75

With a non-tracking console, each value would have to be recorded into each cue as displayed above. However, with a tracking console such as the Hog 4, the only data that really needs to be recorded is much simpler as shown in the table below:

Fixture:	A	B	C
Cue 1	100	50	100
Cue 2		25	50
Cue 3		75	75

As you can see fixture A only has to be recorded at 100% in cue 1 because that value will track all the way from cue 1 to cue 3. On the other hand, since fixtures B and C change value in each cue, the tracking console needs to have unique values recorded in each cue.

When discussing the contents of a cue or the state of playback on stage, the following terms are commonly used:

- **Hard Values / Touched Values:** Values programmed into the current cue

- **Tracked Values / Transparent Values:** Values assigned
- **State:** The summation of both tracked and hard-coded values in playback. The Hog 4 OS automatically recalls the state of any cue regardless of whether or not the cuelist was played in order; this allows the console operator to jump around and play cues out of order while preserving the way the cue was meant to look.

2.5 HTP and LTP

Traditional theater desks that are not designed to handle moving lights will work on a Highest Takes Precedence (HTP) basis. This means that if a fixture's intensity is being controlled by two different parts of the console, such as a playback and a sub-master, the intensity will be at the highest of the two levels. For example, if in the playback fixture 1 is at 50%, and in the sub-master it is at 100%, then the level seen on stage will be 100%. If the sub-master is reduced to 40%, then the on-stage level will be 50%, because the level in the playback is higher and will take precedence.

This system generally works well for non-moving light consoles, but moving lights introduce a problem. Parameters other than intensity don't have 'higher' and 'lower' values: a colour of red is not higher or lower than green, and a pan of 50% is not higher or lower than one of 20%. Working with moving lights needs a new way to decide the precedence, called Latest Takes Precedence (LTP).

With this system, the fixture parameters are at the value they have been most recently assigned. In our example, moving the sub-master to 40% would result in a level of 40%, because this is the latest instruction and will take precedence. The sub-master would effectively 'grab' control of the parameter from the playback. Of course, running another cue in the playback might grab it back again.

Many moving light consoles use HTP for intensity and LTP for all other parameters. By default, Hog 4 OS uses LTP for all parameters, but you can assign individual cuelists to use HTP for intensities (all other parameters are still LTP); see *Highest Takes Precedence (HTP)* (p.311).

2.6 Colour Matching

Fixtures of different types use different methods to perform colour mixing. Sending the same parameter values to fixtures of different types might produce a different colour on each type. For example, sending C=50%, M=50%, Y=0% will always produce a shade of blue, but it'll be a different blue with different fixture types.

Usually, you have to compensate for this yourself by manually creating colour palettes by eye to produce similar colours on all fixture types. This is a time consuming process, and later restricts you to using the palettes you have already set up.

The Hog 4 OS's colour matching system provides a new way to choose colours, without these problems.

2.6.1 Colour Models

Traditionally, colour mixing fixtures use the CMY (Cyan, Magenta, Yellow) system to uniquely define each colour they can produce. With the increasing popularity of LED fixtures, the RGB (Red, Green, Blue) system is also becoming more common. These two systems are called 'colour models'. Any colour can be represented equally well by either of these two colour models - they are just different ways of conveying the same information. Many other colour models exist, perhaps the most useful of which (for lighting control, anyway) is the HSI (Hue, Saturation, Intensity) system:

Hue: This is the term used to specify the colours position in the possible range a colours, from red, going through yellow, green, cyan, blue and magenta, and finally returning to red. As the range 'wraps around', you can visualise it as a circle with the colours positioned around the edge, with red at the top, green at the lower right, blue at the lower left, and the intermediate colours in between. The angle between 0 and 360 degrees specifies the hue of the colour: red has a hue of 0 degrees, yellow has a hue of 60 degrees, and cyan has a hue of 180 degrees; see *Figure 2.4, "The HSI Colour Wheel"*.

Saturation: This is how 'strong' or 'pale' the colour is. Pale colours have low saturations, while strong colours have high saturations. Saturation is specified as a percentage between 0% (white) and 100% (the strongest possible saturation).

Intensity: This is simply a measure of how much light is being emitted, from 0% (black) to 100% (the brightest possible). This is identical to the dimmer control on most fixtures.

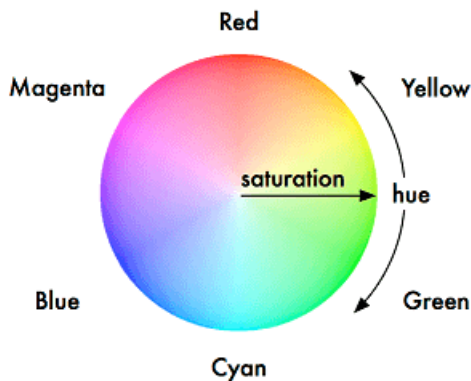

Figure 2.4. The HSI Colour Wheel

With these three pieces of information (hue, saturation and intensity), every possible colour can be represented. As most fixtures already feature a dimmer to control the in-

tensity, it is only necessary to specify the Hue and Saturation to uniquely represent any colour.

The Hue and Saturation of White Light

White is defined as the colour with 0% saturation; the hue doesn't matter. However, while tungsten and arc lamps both produce 'white' light, when you compare them side to side their colours are considerably different. The tungsten lamp has a 'warmer' colour with a higher red and yellow content, while arc lamps usually have a 'cooler' light with more blue in it. One version of white is not more 'correct' than the other, so either may be chosen to be the reference point depending on the situation. In a theatrical environment where tungsten sources are more common tungsten white is likely to be most appropriate base. In other environments predominantly using arc sources, it will be more convenient to use arc white; for information on changing the white point, see *Using Colour Matching* (p.164).

2.6.2 The Colour Matching System

The Hog 4 OS's colour matching system is based on a fixture library that contains colour calibration data for the fixture types in use. This calibration ensures that fixtures of different types can easily be assigned to the same colour, including to a chosen definition of 'white'. It can also be used for fixtures that have not been calibrated, but the colours that will be produced may not match the colours from fixtures that do have calibration data.

You can choose colours using the parameter wheels to assign cyan, magenta and yellow values or hue and saturation values, or you can use the on-screen visual colour picker; see *The Colour Picker* (p.164).

It is preferable to program using Hue and Saturation whenever possible. The advantages are:

- Selecting colours using Hue and Saturation or the colour picker will produce the same visual colour output on all calibrated fixture types.
- You can use fanning and effects on Hue and Saturation to produce attractive looks quickly.
- When you use Hue and Saturation to pick a colour, Hog 4 OS will automatically use the best possible DMX value settings for each fixture type to achieve maximum light output from each fixture.
- You can cross-fade from a saturated red to a saturated green without the saturation changing. The cross-fade will work through all the saturated colours between red and green, rather than taking an unexpected path to get there, as can happen when using CMY programming.
- Cross-fades between colours recorded using Hue and Saturation will remain matched on all fixtures through the progress of the cross-fade. This produces a better, more even-looking colour cross-fade.



Tip

It is strongly recommended that you do not change between the HSI and CMY systems within a show.

2.7 Palettes and Directories

Palettes help to simplify the programming process by allowing pre-defined lighting 'elements' to be created and then used as required. Once you have created a palette, such as a particular set of position settings with moving lights, you can recall those settings instantly, and record them into cues. Palettes are stored in windows called directories.

A great advantage of palettes is that when you record a cue using the palette, the cue contains a reference to the palette, rather than the parameter values that the palette contains. If, later, you change the palette then all cues that have been recorded using the palette are also changed. This is especially useful if, for example, the position of a piece of set on stage is moved, and moving lights have been programmed to light it. The palette can be updated once to accommodate the change, rather than in every cue. For more information, see *Palettes (p.181)*.

Palettes allow intensity, position, colour and beam parameters to be recorded as easily accessible 'building blocks' to be used when programming. Palettes are stored in classified directories. For information on directories see *Directory Windows (p.193)*

When you use a palette to assign parameter values in the Programmer, and then record the contents of the Programmer as a scene or cue, the Hog 4 OS records a reference to the palette rather than numerical values for the parameters. During playback, the console refers to the parameter values stored within the palette when outputting cue data to the stage. Because of this referencing, when you modify a palette's content, the cues and scenes that were programmed using it will, in effect, be automatically updated with the new values. The palette is said to be 'referenced' in the cue. This is a very powerful feature that allows you to make global changes to the show very simply and quickly, rather than having to re-program every cue individually.









If you wish to make a palette that is just a programming tool, where later changes to the palette will not cause cues, scenes and other palettes recorded with it to be updated, then you can use direct palettes. With direct palettes, actual parameter values are placed into cues, rather than references. See *Direct Palettes (p.190)*.



Tip





Hog 4 OS can automatically generate a useful set of palettes based on the fixtures in your show: see *Creating Palettes and Groups Automatically (p.136)*.

Directory windows give you quick access to groups, palettes, scenes, cuelists and so on, and they all work in essentially the same way.

Display	Applies To	Description
.. C .	Palettes	Shows the parameter types recorded in the palette. I = intensity, P = position, C = colour, B = beam, E = effect, T = time. See <i>Recording Palettes with Kind Masking</i> (p.187).
	Palettes	The palette is a direct palette. See <i>Direct Palettes</i> (p.190).
	Palettes	The palette contains references to other palettes. See <i>Reference Palettes</i> (p.190).
	Palettes	The palette is the Highlight Palette. See <i>Customising Highlight</i> (p.282).
	Palettes	The palette is the Lowlight Palette. See <i>Customising Highlight</i> (p.282).
	Cuelists	The cuelist is a chase. See <i>Using a Cuelist as a Chase</i> (p.323).
	Cuelists	The cuelist has timecode active. See <i>MIDI</i> (p.367).
	Cuelists	The cuelist has clock triggers that are enabled. See <i>Clock Triggers</i> (p.251).
	Pages	The page is the template page. See <i>The Template Page</i> (p.342).
	Pages	The page has a Restore Activity macro defined. See <i>Restoring Activity When Changing Pages</i> (p.338).

You can rename the selected button (with the red border) by pressing the Set key. You can also hold Set and press any button to rename it.

At the top of the window there are four buttons common to all directories:

	Switches to a spreadsheet view, allowing you to edit attributes of the items in the directory such as their names. See <i>Spreadsheets</i> (p.37) and <i>Figure 2.5, "A Typical Directory in Spreadsheet View"</i> .
	Reports. This allows you to print the contents of the window.
	Configure. This allows you to control various aspects of how the directory window displays information.
	When this is depressed, pressing the directory's buttons does not activate them. Instead it selects the item and inserts it in the command line.

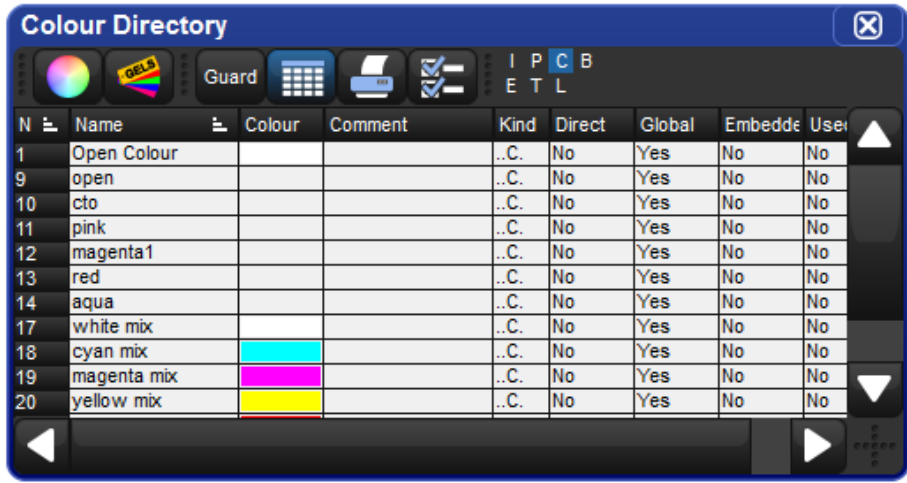

Figure 2.5. A Typical Directory in Spreadsheet View

**Tip**

You can override the effect of the Guard button by holding down the Pig key while pressing a directory button.

2.7.1 Automatic Naming of Directory Items

When you create or copy a directory item, the console automatically generates a name for the new item. For example, if you have two position palettes and then create a third, the new one will be recorded into location 3 in the directory and named 'Position 3'. If you then copy this position palette, the copy will be recorded into location 4 in the directory and named 'Copy of Position 3'.

You can customise how the console automatically generates these names in the Default Naming pane of the User Preferences window; see Figure 2.6, "The Default Naming pane of the User Preferences window". To open the Default Naming pane:

- Setup → Preferences → Default Naming

To customise the generated labels:

1. Click or press on the text box for the required type of directory (group, intensity, position, and so on). Labels for when the new directory item is created by recording or by copying are handled in separate text boxes.
2. Set, [**new label text**], Enter : type in the label you want.
3. Alternatively, click or press on the arrow at the right hand end of the text box to get a list of useful labels. Click on the one you want.



Figure 2.6. The Default Naming pane of the User Preferences window

You can use special tags to have the console insert text into the name for you, according to the directory name and the location in the directory:

- **&d:** the directory name
- **&D:** the directory name (dynamic)
- **&n:** the directory number
- **&N:** the directory number (dynamic)
- **&o:** the original text. This is used when a directory item is copied; the original text is the name of the item that has been copied.

Lowercase tags are resolved once only, when the name is applied, while uppercase tags remain unresolved until the name is displayed (known as ‘dynamic’). So, pressing Set and entering the name of colour palette 3 as ‘&d &n’ will assign the name to be ‘Colour 3’. If you assign the name to be ‘&D &N’, the name will also be assigned to ‘Colour 3’. The difference is that moving this palette to position 4 will automatically correct the name to ‘Colour 4’.

2.7.2 Colour Coding Directory Items

Each directory window allows for unique colour coding of each button within the directory. The default colour for new directory items is standard grey. When you copy a

directory item, the console will automatically copy the directory item's custom colour as well see *Figure 2.7, "Directory Item Colour"*.

Note: The playback bar, view toolbar, and commands keys automatically reflect the color-coding of the objects that they display. Color-coding for these objects can only be changed in the directory and the is thus reflected everywhere that object is shown.

To customise a directory item in button view:

1. Using the mouse, right click on the directory button to open the right click menu.
2. Click on one of the 15 options shown in *Figure 2.8, "The Preset Colour Options"* to assign the directory item this colour.
3. Alternatively, click on Custom to select a custom colour from a colour wheel or click None to select the standard grey colour. Click on Auto to have palettes in the Colour directory automatically determine the button color based upon the dominate colour value recorded in the palette.

To customise a directory item in spreadsheet view:

1. Select the Colour cell and press Set to open the colour selection menu.
2. Click on one of the 15 preset colours to assign the directory item this colour.
3. Alternatively, click on Choose to select a custom colour from a colour wheel or click None to select the standard grey colour. Click on Auto to have palettes in the Colour directory automatically determine the button color based upon the dominate colour value recorded in the palette.



Tip

You can select multiple buttons or cells by clicking and dragging to assign the same colour to multiple items.

2.8 Spreadsheets

Similar to Excel spreadsheets, many windows in the Hog 4 OS such as the programmer, output window, and cue editors are presented as spreadsheets.

All of the spreadsheets in the Hog 4 OS share a common set of features:

- **To resize a spreadsheet column:** Place the cursor over the right-hand edge of the column header. The cursor will change to a double-ended arrow. Click and drag to resize the column.

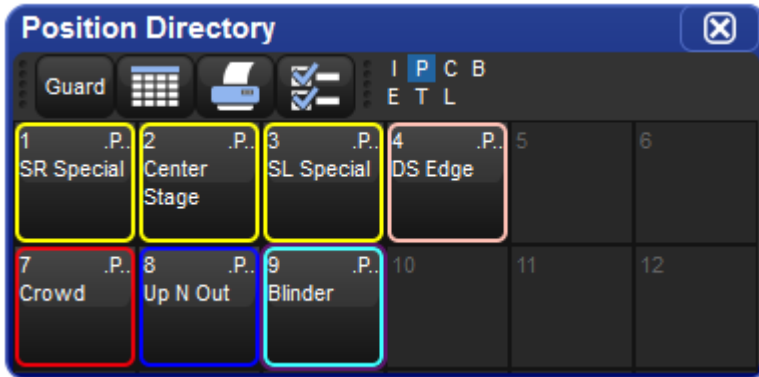
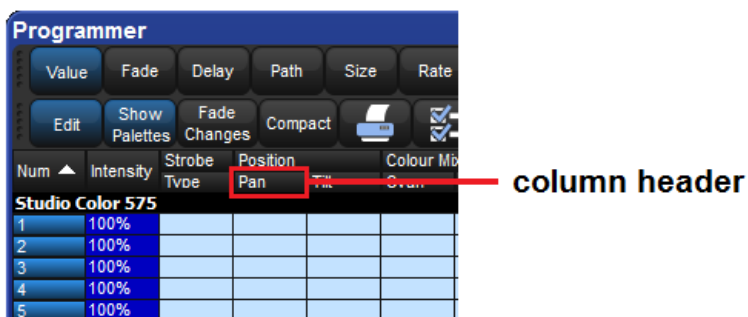

Figure 2.7. Directory Item Colour



Figure 2.8. The Preset Colour Options



- **To move a spreadsheet column:** Click and drag on the column header.
- **To hide a spreadsheet column:** Right-click on the column header, and choose Hide.
- **To show a hidden spreadsheet column:** Right-click on a column header, and choose the name of the column from the menu.
- **To sort the spreadsheet:** Right-click on a column header and select Sort to sort the spreadsheet by the values in that column. Select Sort again to reverse the direction of the sort. You can also right-click on a column header and select Sub-sort to assign a second level of sorting. For example, if you sort the Fixture window by fixture type, and sub-sort by Patch, then all the Desk Channels will be shown grouped together, in the order of their patch address.
- **To select all the cells in a spreadsheet column:** Double-click on the column header at the top of the spreadsheet.
- **To select a single spreadsheet cell:** Click or press in the cell. You can use the cursor keys below the Trackball to change which cell is selected. If the cell is editable, it will have a red border.
- **To select a range of cells in a spreadsheet:** You can click or press and then drag across a range of cells to select them all. Alternatively, you can click in the first cell, press and hold Thru, and click in the last cell; this is useful if you want to select a large range and need to scroll the window.
- **To edit the contents of cells in a spreadsheet:** Click or press in the cell and press the Set key, or double-click in the cell. Type in the new value, and press Enter. This works for both a single selected cell and a range. Cells that are editable have a red border when selected. Cells labeled Colour in cue lists and scenes will open the colour selection dialog to allow you to colour code the cell.

2.8.1 Compact Mode

In editor windows such as the Programmer, you can use compact mode to save space and get more information onto the screen without having to scroll; see *Figure 2.9, "A spreadsheet with and without Compact Mode"*. In compact mode, fixtures only have columns for the actual parameters that they have, rather than for all the parameters of any fixture in the editor. The console uses the display space more efficiently by having multiple columns for fixture types with few parameters, such as desk channels.

You can toggle compact mode on and off with the Compact button in the window's toolbar.

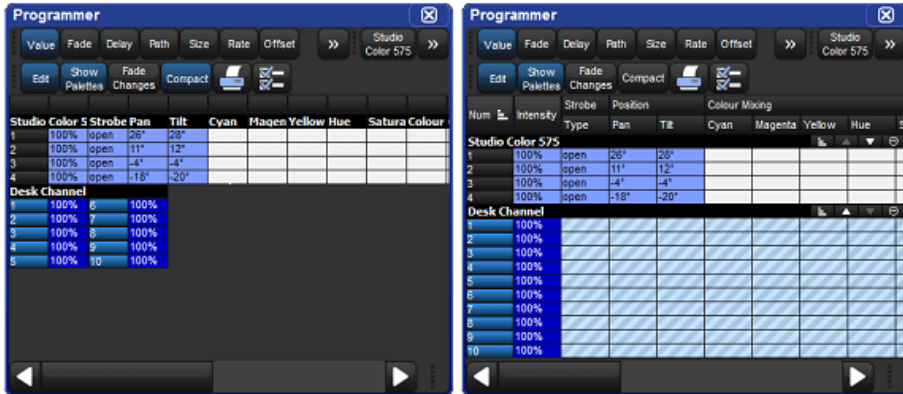



Figure 2.9. A spreadsheet with and without Compact Mode

Note that you cannot sort a spreadsheet that is in compact mode.

2.8.2 Aggregation

In windows such as the Programmer, it is often useful to keep fixtures of the same type together; this is known as 'aggregation'. The spreadsheet effectively becomes a list of fixtures in fixture type order, with headings in the list separating each fixture type; see *Figure 2.10, "A Spreadsheet with Aggregation Turned On"*.

To use aggregation:

1. Make sure the spreadsheet is sorted by Fixture Type: right click on the Type column and select Sort. If the Type column isn't visible, right click on any column heading and select Type.
2. Press  to open the Configuration window.
3. Select Enable Aggregation.
4. Click on OK.

Note that aggregation is always on if the spreadsheet is in compact mode; see *Compact Mode (p.39)*.



Tip

Aggregation is turned on by default in all editors, such as the Programmer.

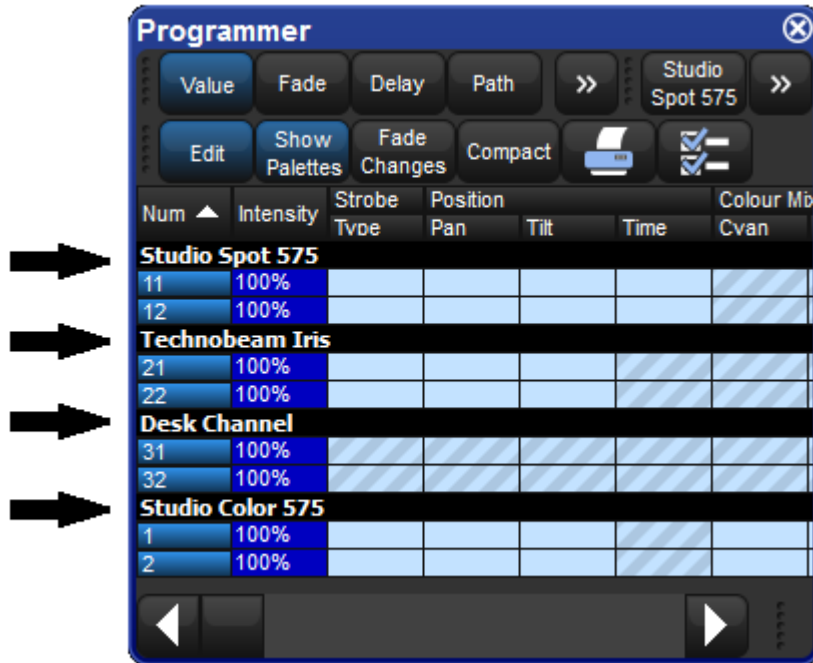

Figure 2.10. A Spreadsheet with Aggregation Turned On

Collapsing Aggregated Sections

You can collapse aggregated sections to hide all the rows in that section; see *Figure 2.11, "An Aggregated Spreadsheet With Collapsed Rows"*. To collapse an aggregate section, right click the black heading bar and select Collapse.

To expand the aggregation section again, right click the section's black heading bar and select Expand.

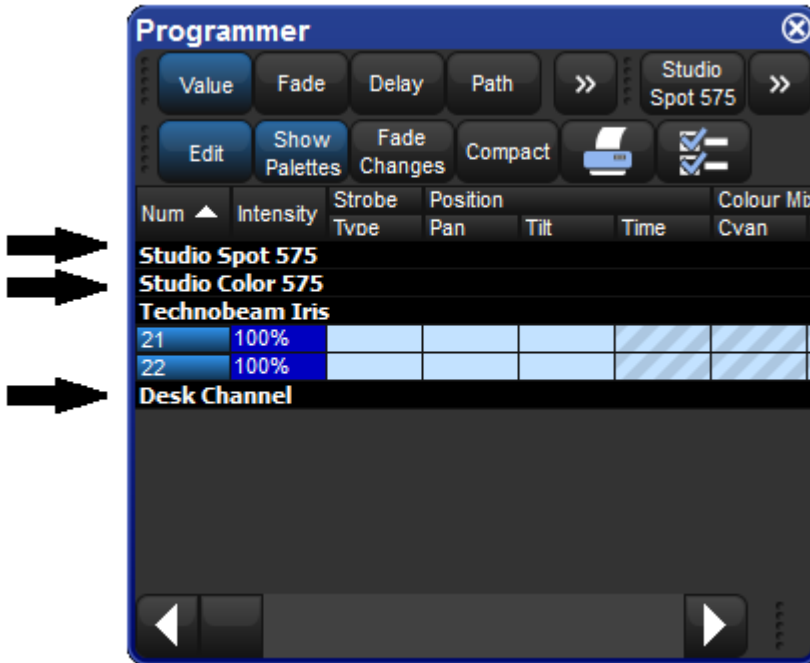

Figure 2.11. An Aggregated Spreadsheet With Collapsed Rows

Priority of Aggregated Sections

You can change the position of an aggregation section in the list by altering its priority. Raising a section's priority will make it appear nearer the top of the spreadsheet.

To move an aggregate row up or down in priority, right click the section's black header bar and then select Raise Priority or Lower Priority.

Jumping Between Aggregated Sections

You can quickly bring aggregated sections into view using the Jump Toolbar located on the upper right of a spreadsheet window, see *Figure 2.12, "The Jump Toolbar"*. This has a button for each aggregation section; clicking a button will scroll the list to bring the section into view.

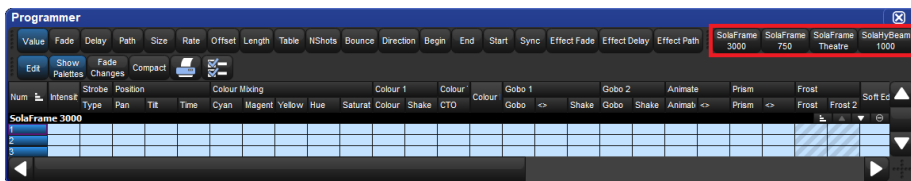

Figure 2.12. The Jump Toolbar

To enable the jump toolbar:

1. Press



to open the Configuration window.

2. Select Enable Jump Toolbar.
3. Click on Apply.



Tip

The jump toolbar is turned on by default in all editors, such as the Programmer.

2.8.3 Cut, Copy and Paste

You can copy and paste the contents of selected cells:

- Right-click, and select Copy or Paste from the contextual menu.

Or:

- Pig + Copy : copy.
- Pig + Move : paste.

2.9 Editors

Editors are windows where you can view and assign the parameter values of fixtures. The most important editor in the Hog 4 OS is the programmer which acts as the default active editor for all parameter changes when no other editors are open or active. Individual cues, scenes, and palettes can all be opened in editors. Editing parameter values works in essentially the same way for all of editors; see *Selecting Fixtures and Modifying Parameters* (p.147).

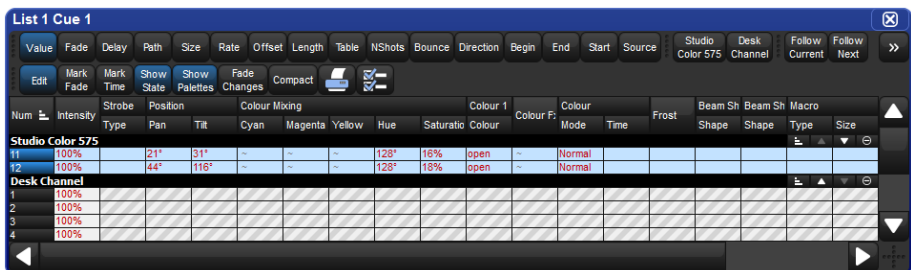

Figure 2.13. A Typical Editor

You can open an editor window for any cue, scene or palette by holding down the Open key and selecting it from its directory window. Alternatively, you can use the command line:

- Cue 1 Open : opens an editor for Cue 1 and makes it editable.

2.9.1 Editor Window Controls

The main part of an editor window shows the fixture parameter values in a spreadsheet view, with each row representing a single fixture; see *Spreadsheets* (p.37).





At the top of the window there are three toolbars with buttons: the Editor Values Toolbar toolbar, the Editor Toolbar, and the Jump Toolbar. The following sections describe the buttons that are common across all editors; some editors have additional buttons that are specific to that type of editor, and these are described in the relevant part of the manual.

The Editor Values Toolbar

The Editor Values Toolbar has buttons for: Value, Fade, Delay, Path, Size, Rate, Offset, Length, Table, and N Shot. Use these buttons to display the different kinds of information associated with the fixture's parameters; see *Fade, Delay, and Path* (p.238).

The Editor Toolbar

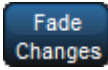
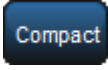
The Editor Toolbar has the following buttons:

Button	Purpose
	Press this to make the contents of the editor editable, rather than just to view it. Instructions given to the command line, or using the parameter wheels and I-Wheel, are directed to the editable editor.
	In cue editors, press this to see all the parameters that will appear on stage, including those that have tracked through from earlier cues in the cuelist. With Show State deselected, only the hard values actually recorded in the cue are displayed.
	Press Show Palettes to see the palette name, rather than the parameter value; see <i>Palettes</i> (p.181).
	Press this to have parameter values changed in this editor fade rather than snap onto stage; see <i>Fade Changes</i> (p.285).
	Press this to toggle compact mode on and off. Compact mode fits more information into the editor without having to scroll. However, the column for a particular parameter won't necessarily be aligned across different fixture types, so sorting is not possible.
	Reports. This allows you to print the contents of the window.
	Configure. This allows you to control various aspects of how the editor window displays information.

The Jump Toolbar

The Jump Toolbar has a button for each type of fixture currently in the editor, allowing you to quickly jump to the parameter values for that type of fixture. The Jump Toolbar only appears if aggregation is turned on; see *Aggregation* (p.40).

2.9.2 Changing Parameter Values in the Editor

To make changes to the contents of an editor, you need to have its Edit button selected. You can have up to eight editors open, but only one can be editable at a time, and the parameter wheels, I-Wheel and command line all operate on the contents of the currently editable editor. If you have several editors open at once, you can use the Edit button to determine which one you are controlling (even if it is not the front-most window) or to 'lock' the editor to prevent accidental changes.



Tip

When you open an editor, all the fixtures within the editor are automatically selected. This aids quick editing of cues or palettes. You can also deselect the Select All on active editor option under the Misc tab of the preference window so that editors can be opened and closed without changing fixture selection.

After you have finished editing a cue, scene or palette, press the Update key to apply changes. Until you do this, changes won't show up if you run the cue or scene, or use

the palette. The exception to this is when you are working in the Programmer, when the Update key will perform the Auto Update function; see *Auto Update* (p.283).

If you hold down the Update key, the Update Toolbar will appear. This allows you to select which parameter types are recorded, whether changes should track forwards, and whether references should be allowed when recording palettes. See *Stopping Values from Tracking Forward* (p.220) and *Reference Palettes* (p.190).

If you close the editor without updating, you will be asked whether you want to save or discard the changes, or cancel the closing of the editor.



Tip

The name of the current editable editor is shown in the Command Line Toolbar. By default, it is the Programmer. The name of the item being edited appears in the title bar of the editor window.

2.10 Modifier Keys

The Hog 4 family of consoles all share a common set of useful multi-purpose modifier keys that when held down extend the base functionality of other keys and wheels on the front panel similar way to a Shift or Control key works on personal computers. There are several modifier keys but the core modifier keys in the Hog 4 OS are Pig, Open, Delete, Backspace, Set, Cue and Move.



Pig Key Modifier Examples:

1. Pig + I-Wheel : Changes wheel to proportional intensity mode.
2. Pig + Move : Pastes information into the selected location.

Hog 4 OS Key Combinations (p.475) has a full list of commands that use the Pig key.

2.11 Undo and Redo

The Undo button found on the Main Toolbar is similar to the undo command found in computer applications, allowing the user to work back through the last commands entered by the user, undoing them each time the button is pressed. In the Hog 4 OS the

undo key is global, working back through operations in chronological order, and you can go back all the way to the point at which you logged on to the console (generally, this is when you started the console up). In cases where multiple consoles are networked together the undo task will only undo actions of the local desk.

Pressing the Pig button, together with the Undo button, will redo the last undone action. Again, if you have gone back through several undos, you can redo repeatedly until you get back to the most recent action.

The undo and redo feature works on your show data, but generally not on other things.

Undo is not available for:

- Changes to the fixture selection in the Programmer. However, the selection may change as a side effect of an undo action.
- Changes to Control Panel settings, and other things not directly related to your programmed show.
- Changes to window positions and views, and the like.

If undo is not available, you will always be asked to confirm important changes before they take place.

2.12 The File Browser

You can browse and organize several different kinds of system files in the File Browser pane of the Show Manager window; see *Figure 4.2, "The Show Manager Window"*. On the left is a list of the main console folders and the console's drives. Clicking on one of these will display its contents in the right hand list.

The browser shows the name, description, and creation date and time of the file, as well as the version number of the library used to create the show in parentheses. If the show is marked as modified, then the library has been altered through a library merge.

2.12.1 Moving, Copying, Deleting and Renaming Files

To move a file:

- Drag and drop files to destinations in the left hand folder list. Generally, you will find dragging with the mouse or Trackball much easier than using the touchscreen.

To copy a file:

- Drag and drop files while holding down the Pig key (or the Control key on an external keyboard).

To delete a file:

- Right-click on the file and select Delete from the contextual menu. You will be asked to confirm the action.

To rename a file:

- Right-click on the file and select Rename from the contextual menu. Type in the new name and press Enter.



Tip

You can also copy and paste files by right-clicking on them and selecting Copy or Paste from the contextual menu.

2.12.2 Creating New Folders

You can create sub-folders in the Shows and Libraries folders to help organise your work:

1. Click on the folder you want to make a new folder in.
2. Click on the  button.
3. Enter a name for the folder and press Enter.

Note that you cannot create folders on a CD-ROM.



Tip

You can also create a new folder inside an existing one by right clicking on it and using the contextual menu.

2.12.3 Ejecting Disks

You cannot eject a disk in the console' CD drive if it is in use. Before ejecting, make sure that you don't have the disks folder selected in the File Browser. If a disk will not eject, check that you are not browsing its contents elsewhere, and that the console is not currently accessing it.

2.12.4 Burning files to CD

To burn files onto a recordable CD:

1. Setup → Shows → CD Burning : see *Figure 2.14, "The CD Burning pane of the Show Manager window"*.
2. Select a file to be copied in the left-hand list, and click the Add to CD button to move it to the right-hand list. You may be asked to archive the file before adding it to the list; click OK to agree to this.
3. Repeat for all the files you want to copy to the CD.

4. Insert a recordable CD into the CD drive, located under the console's front wrist rest.
5. Press the Burn button, and then the Start Burn button in the CD Burning window. The window will show the progress of the writing operation.

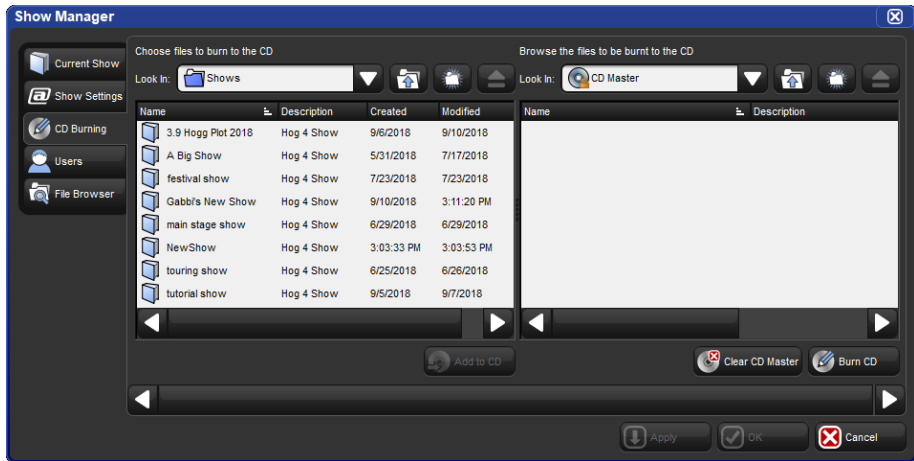

Figure 2.14. The CD Burning pane of the Show Manager window



Tip

You can use drag and drop to move files to the CD Master list. Note that files will always be copied, not moved.

Section 3: Setting Up the System

3.1 Setting Up the Console

3.1.1 Starting Up the Console

To power on and start up the console plug one end of a standard IEC power cable into any 100-220 VAC power source and plug the other end into the console's dedicated IEC power port and then turn the power switch on the back of the console to the on position. Make sure that any external bootable media such as bootable USB flash drives or CDs are removed from the console before booting as the console may try to boot to that media instead of to the installed operating system. When the console has finishing booting you will see two windows: the Hog 4 OS splash screen and the Hog 4 OS start screen. Your console is now ready for operation.



Important

Using an ungrounded power source leads to a greater risk of shock and may cause the motorized faders on the Hog 4 and Full Boar 4 consoles to not function properly. Always make sure that the power source for your console is properly grounded.

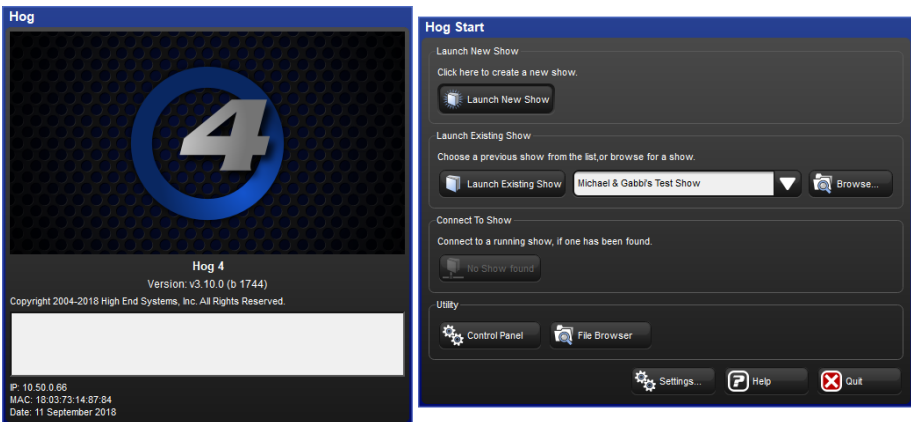

Figure 3.1. Start Screen, your console is ready to use

3.1.2 Adjusting the Date and Time

The console has a built in clock which is shown at the far right end of the command line toolbar. To change the console's date, time, and time zone open the Control Panel and navigate to the Time and Date tab. To change the format in which the console displays the date and time in your show file open the Preferences window and navigate to

the Appearance tab. The format preference is stored in the show file and will change based on which show file you load.

Note: In order to permanently store changes made to the time and date of the console you must restart the Hog 4 OS or properly shutdown/reboot the console. Simply switching the console's power switch off/on will result in any time and date changes being lost.

3.1.3 Calibrating the Touch Screens

The touch screens may occasionally need to be calibrated. To recalibrate the touchscreens before launching a show, select the Touchscreens button in the Start window. Touch each target as it appears sequentially; see *Figure 3.2, "The Calibration Screen"*. After the calibration sequence is complete, press Enter. You can press the Set key to start the process again if necessary. You can also calibrate the touch screens at any time while loaded in a show by pressing the Calibrate Touch Screens button in the Displays pane of the Control Panel. Users can also start the touchscreen calibration at any time on their console by holding the Setup key and pressing the encoder wheel button below the first main encoder wheel.

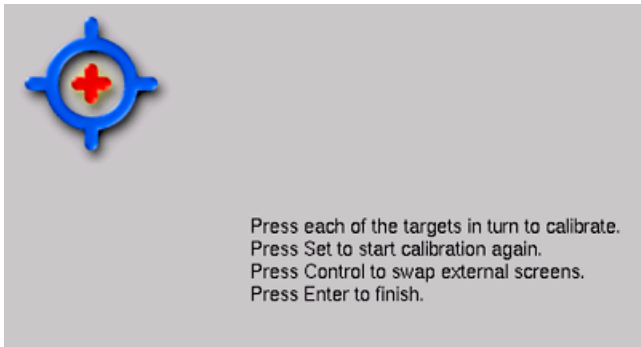

Figure 3.2. The Calibration Screen

3.1.4 Adjusting the Touchscreen LCD Backlight

You can adjust the brightness of the built-in touchscreens by adjusting the LCD backlight settings of the console (Hog 4 and Full Boar 4 only). To adjust the LCD backlight hold down the Setup key and adjust the parameter wheels labelled Left Backlight or Right Backlight.



Tip

If you find the graphics on the screens are too bright, you can change the console's colour scheme to a darker one in Setup → Preferences → Appearance.

3.1.5 Changing the LCD Backlight Timeout

The backlights that illuminate the console's primary touch screens switch off automatically after a period of time if the console is idle. You can adjust the amount of time the backlights will wait before switching off in the Appearance pane of the User Preferences window:

1. Setup → Preferences → Appearance
2. Adjust the Backlight Off time located at the bottom of the pane, either by pressing the arrows to increment or decrement the value, or by clicking on the value, pressing Set and typing in a new value.
3. Select OK to apply and close.



Tip

Once the Hog displays are asleep you can wake them up by pressing any key. It is a good idea to use the Pig key as this will prevent you from accidentally changing any data within the show.

3.1.6 External Touchscreens / Displays

A wide variety of external displays and USB touchscreens are supported on the Hog 4-18, Hog 4, Full Boar 4, Road Hog 4, and HedgeHog 4x consoles. When an external touchscreen is required High End Systems recommends using Master Wing 4 or Playback Wing 4 for the greatest level of compatibility and integration.

For stand-alone touchscreen monitors High End Systems recommends using plug'n play "Windows Compatible" touchscreens that do not require proprietary drivers.

The touchscreens listed below have been tested for compatibility by High End Systems:

Manufacturer	Model	Size	Part Number
Acer	T232L	23"	UM.VT2AA.001
Acer	T230H	23"	ET.VT3HE.001
Dell	P2314T	23"	1RNV2
Dell	E2014T†	20"	E2014T†
Dell	S2240Tb	21.5"	09XJW
Dell	P2418HT	23.8"	P2418HT
ELO	AccuTouch ET1229L	12"	All Part No.
ELO	AccuTouch ET1215L	12"	E432532
ELO	AccuTouch ET1725L	17"	E103047
ELO	iTouch ET1519L	15.6"	E232070
ELO	iTouch ET1919L	18.5"	E176026
ELO	Intellatouch Plus ET2201L	22"	E107766
GeChich	on-Lap 1303i	13.3"	13031000109
Hannspree	HT225HPB	21.5"	HT225HPBREJ01
iiyama	Prolite T2252MTS	22"	PL2252MT
iiyama	Prolite T2235MSC	22"	PL2235M
Lenovo	T2364†	23"	T2364†
VIEWSONIC	TD2340	23"	VS15023

To connect an external display and/or touchscreen to your console:

1. Power off the console.
2. Connect the external display's video signal cable to one of the video output connections on the back of the console. A video adapter may be required (see tip below).
3. If using a touchscreen: connect a USB cable from the touchscreen to one of the USB ports on the console.
4. Turn on the console.
5. In most cases each external monitor's native resolution will be detected by the console and no further adjustments to resolution will be required. In cases where the external monitor's resolution is not properly set automatically, press the control panel button on the start screen to open the control panel.
6. Select the "displays" tab of the control panel. Use the appropriate drop down menus to select a custom or preset monitor resolution, orientation, and/or position for the external display and then press the apply button.
7. If using a touchscreen: press the first encoder wheel button while holding down the setup key on the front panel. This will start the touchscreen calibration utility.

8. Touch all of the calibration targets on both the internal and external touchscreen displays. Once calibration is complete the cursor should follow your finger on both the internal and external touchscreen displays.



Tip

The Hog 4-18's display port output connections are compatible with native display port displays as well as with ACTIVE display port video adapters.

The Hog 4-18's display port outputs are NOT compatible with PASSIVE display port video adapters.

The Full Boar 4's DVI-D output connections do not support analog output to VGA displays such as those featured on the older Full Boar 3 playback and programming wings.

The Road Hog 4's VGA output is not supported. Although some VGA monitors may work on this port it is advised to only use the DVI-D output on the back of the Road Hog 4.

3.1.7 Keyboard

Using an External Keyboard

You can connect an external keyboard to the console via the console's USB ports. Choose a keyboard model, and assign the keyboard layout according to the language of the keyboard you have connected, in the Keyboard pane of the Control Panel.

You can adjust the timings for Repeat Delay, Repeat Period, and Double Press in the Key Timings pane of the User Preferences window.



Tip

You can use an external keyboard to control many of the console's functions, as well as entering numbers and text; see *QWERTY Keyboard Shortcuts (p.473)*.

Using the On-screen Keyboard

You can use the on-screen keyboard to enter text when an external keyboard is not present; see *Figure 3.3, "The On-screen Keyboard"*. When prompted to insert text, press the Set key to launch a touch-screen keyboard. You can use the Pig key as a 'shift' for uppercase characters. Press the Enter key when you have finished typing.

To close the on-screen keyboard without making any changes, press Set instead of Enter.



Figure 3.3. The On-screen Keyboard

3.1.8 Trackball

Using an External Trackball

External USB trackballs can be connected to the console via the console's USB ports. Most external USB trackballs are supported only as an external mouse with left and right click capabilities however a select set of trackballs (listed below) are fully supported as functional Hog 4 OS trackballs (support for all four trackball buttons and support for the use of the trackball in both pointer and POS mode):

Kensington Expert Mouse (Model K64325)

Kensington Orbit Wireless Mobile Trackball (Model K72352US) - (note: does not have top left and top right buttons)

Kensington SlimBlade Trackball (Model K72327US)

3.1.9 Shutting Down and Restarting the Console

To properly shut down or restart the desk, select Setup → Quit. The Quit button is on the right hand end of the Setup Toolbar. After press the quit button the Shut Down dialog will open (see *Figure 3.4, "The Shut Down Dialog"*), with the following options:

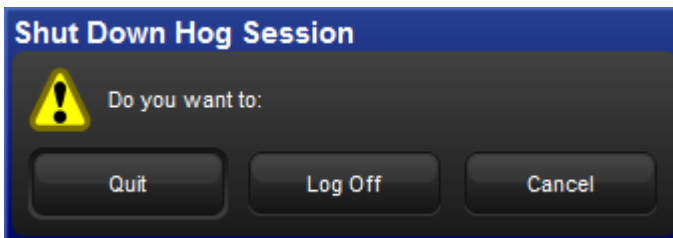

Figure 3.4. The Shut Down Dialog

- **Shut Down:** Shutting down the console exits the software completely. All Art-Net, sACN, and 5-pin DMX transmission from the console is

completely turned off. DP8000s attached to the show will stop transmitting Art-Net and sACN but will continue to output 5-pin DMX at a low 2 Hz refresh rate until they are powered off. Please note that shutting down the console does not power off the desk. To completely turn off the console's power flip the power switch to the off position. For HedgeHog consoles press and hold the power switch for 3 seconds.

- **Restart Console:** Restarting the console exits the Hog software completely, resets the computer, and re-boots the console to the start window. All Art-Net, sACN, and DMX 5-pin transmission from the console is turned off. DP8000s attached to the show will stop transmitting Art-Net and sACN but will continue to output DMX 5-pin at a low 2 Hz refresh rate until powered off or loaded into another show.
- **Log Off:** Log off closes the current show file and returns to the user to the start window. The contents of the programmer as well as any cuelists or scenes that were active in playback will continue to output from the 5-pin DMX outputs of the console and DP8000s at a low 2 Hz refresh rate until you log onto another show or until the console is powered off. Art-Net and sACN transmission is completely turned off on the console and DP8000s upon log off.
- **Cancel:** cancels the quit command.

In all cases your show data is automatically saved to disk.

3.1.10 Locking the Console for Access

Consoles can be locked for access at any time by hitting the setup key on the console front panel and then pressing the lock button on the quit toolbar. Consoles can also be locked remotely by enabling the "lock local access" button under the security tab of the console settings window for the console on the network you wish to lock.

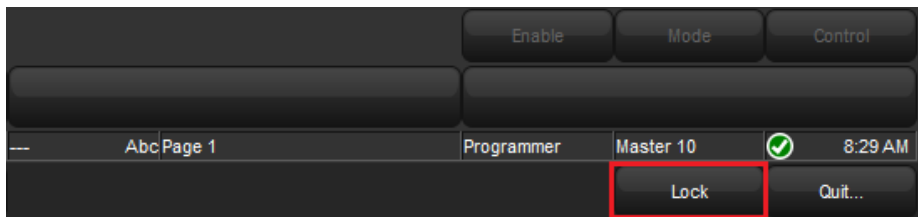

Figure 3.5. The Lock Button on the quit toolbar

When the console is locked the user cannot access any part of the show file or change any dmx output to the stage. To unlock the console enter the PIN code you have setup for your console using the touch screen, the numeric keypad on the front panel, or an external keyboard. When a custom lock image is used the onscreen keypad will auto-hide after a few seconds. If the onscreen keypad is not shown on the displays then press the **pig** key on the console's front panel or the **Ctrl** key on the keyboard and the onscreen keypad will reappear.

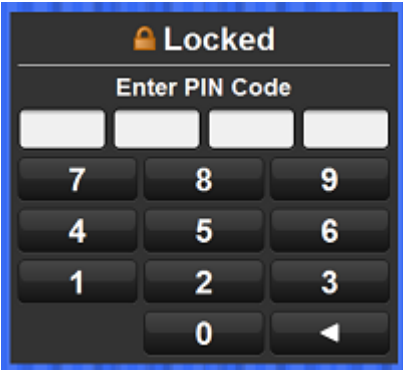

Figure 3.6. The Lock Window Requesting Pin

By default the lock code for consoles is 1234. To change the lock PIN code for the console open the network window, right click on the console you want to change the settings for, click on settings, and navigate to the security tab. Change the PIN code to the desired value and hit apply.

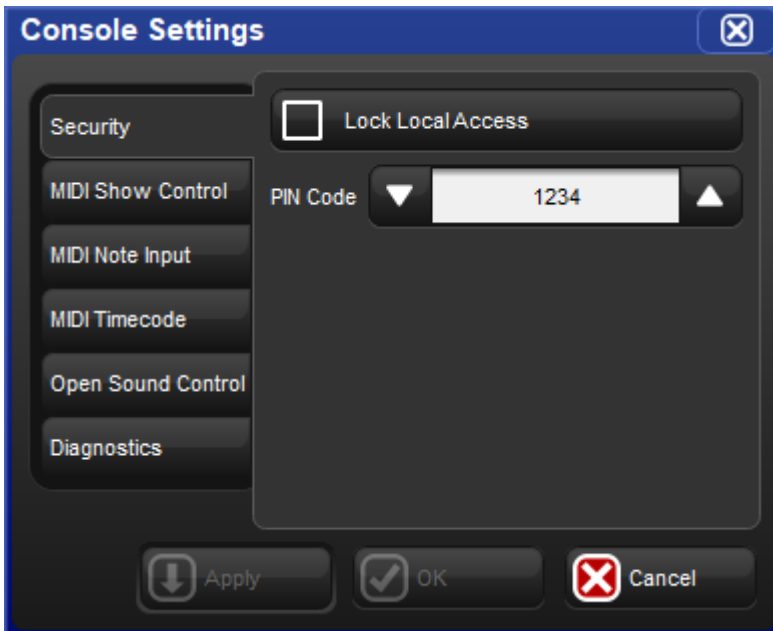

Figure 3.7. Security Settings Tab of Console Settings Window

If you forget the passcode and are locked out of the console you will need to powercycle the console and relaunch the show in order to regain access to the show. Lock pin codes are stored per show and per console.

Custom Lock Screen Image

To specify a custom lock screen image:

1. Open the Control Panel and select the Displays tab.
2. Press the Set Lock Image button.
3. Choose an image file using the file browser window that pops up and then press OK.

The following formats are supported for custom lock images: JPEG, PNG, and BMP.

High End Systems recommends the following image resolutions for each console:

Hog 4-18	1920 x 1080
Hog 4	1280 x 768
Full Boar 4	1366 x 768
Full Boar 4 (2016 and later model)	1920 x 1080
Road Hog 4	1680 x 1050
HedgeHog 4	1280 x 800

To revert the console back to the standard lock screen image press the Reset" Lock Image button in the displays tab of the control panel. Custom lock screen images are stored per console and persist for all show files loaded on the console. Lock screen images are NOT stored per show.

3.1.11 Mounting Accessories to Hog 4-18

The Hog 4-18 console features two 5/8" spigot receivers; one on the left arm and one right arm of the console. These mounting receivers can be used to attached accessories arms for mounting monitors, laptops, tablets, and other devices to the console.

3.2 DMX Processor 8000 Setup

To begin setting up your DMX Processor 8000 plug in mains power at any voltage between 100 and 240V AC. The DMX Processor 8000's most fundamental settings are available using the built in front panel menu system.

To navigate through the front panel menu system of the DMX Processor 8000:

- ◀ Move the cursor through the options backwards.
- Select the option currently highlighted by the cursor.
- Move the cursor through the options forwards.

3.2.1 **Setting the Net Number**

The net number is displayed on the main screen of the DMX Processor in the top right-hand corner. To assign the net number:

1. Main → Network : navigate to the Network Configuration screen.
2. Assign the net number to any value between 01 and 99.
3. OK : return to the Main screen.

3.2.2 **Setting the Port Number**

To assign the Port Number:

1. Main → Network : navigate to the Network Configuration screen.
2. Assign the Port Number as required.
3. OK : return to the Main screen.

3.2.3 **Setting IP Addresses for the HogNet Adapter on a DMX Processor 8000**

By default, DMX Processor 8000s are set to use **DHCP** to get an **IP address** automatically from a Hog console. You can turn this off in the IP Config screen:

1. Main → Network → Console → Console Link Config : navigate to the IP Config screen.
2. Set DHCP On or Off.
3. OK : return to the Console Link Status screen.
4. Close : return to the Network Configuration screen.
5. OK : return to the Main screen.

You may want to assign a fixed or 'static' IP address, perhaps if the Hog system is sharing a network with non-lighting devices such as personal computers. You should contact your system administrator to determine the optimum settings for your network.

To assign a static IP address:

1. Main → Network → Console → Console Link Config : navigate to the IP Config screen.
2. Set DHCP Off.
3. Set the IP Address and Subnet Mask as required.
4. OK : return to the Console Link Status screen.
5. Close : return to the Network Configuration screen.
6. OK : return to the Main screen.

3.2.4 Setting the DMX Processor DMX Output Refresh Rate

You can use set the DMX Processor's dmX output refresh rate from 2HZ to 42HZ. The default dmX refresh rate for a new show is 25HZ.

To set the dmX refresh rate of a DMX Processor locally using the on-board LCD panel:

1. Select DMX from the main menu.
2. Use the front panel buttons to set the desired dmX refresh rate.
1. Setup → Network on the Setup Toolbar. Select the required DMX Processor in the network window and click Settings.
2. Select the dmX tab of the dmX processor settings window.
3. Enter the desired dmX refresh rate in the dmX refresh rate field and press apply. NOTE: In order to achieve rates above 29Hz users must first set the inter-slot time of the DP8000 to 0 microseconds. For refresh rates below 29Hz users can choose to use either 0ms or 20ms as the inter-slot time.

3.2.5 Setting the DMX Processor back to Defaults

In the Control Panel screen you can set the DP back to it's factory default settings:

- Main → Control PanelSet to Defaults.

3.2.6 Locking the DMX Processor Front Panel Controls

You can use the Lock function to lock the DMX Processor's controls. The default PIN is 1234; a new PIN can be assigned from a Hog console via Setup → Network on the Setup Toolbar. Select the required DMX Processor in the network window and click Settings. Change PIN and OK to apply and close the window.

To lock the DMX Processor locally:

- In the Control Panel, select Lock : the Enter PIN to Unlock screen will appear.

To unlock the DMX Processor locally:

- Enter your chosen 4-digit code number, and cursor right to confirm. The code number will be the default 1234 if you have not changed it to your own.

You can lock and unlock remotely from a console via the DMX Processor Settings window for each specific DMX Processor:

1. Setup → Network : the Network button can be found on the Setup Toolbar.
2. Select the required DMX Processor in the Network window and click Settings to open the DMX Processor Settings window.

3. Lock or unlock the DMX Processor and OK to apply and close the window.



Important

Make sure that you keep a record of your lock code close to hand if your DMX Processor is located away from the console. The DMX Processor cannot be unlocked without it or a console operator.

3.2.7 **Backlight Off Time**

Selecting Backlight in the Control Panel opens a screen where you can assign the delay time before the backlight goes off. The Permanent setting keeps the light on continually.

3.2.8 **Watchdog**

The Watchdog feature automatically restarts the DMX Processor if its software stops running for some reason. Watchdog is on by default, and generally it is best to leave it switched on. However, if you suspect that an DMX Processor is not working correctly, you may want to turn Watchdog off so that you can see any error messages before re-starting it:

1. In the Control Panel, select Watchdog.
2. Deselect the Watchdog check box, and select OK.

3.2.9 **Resetting the DMX Processor**

There are two types of reset: soft and hard. Soft Reset resets the DMX Processor so that it re-initialises communication with the network. Hard Reset is equivalent to turning off and on the DMX Processor's mains power. You can do both types of reset from the Control Panel. In addition, you can reset a DMX Processor by right clicking on its entry in the Network window of the console (Setup → Network) and selecting Reset Node.

3.2.10 **Checking a DMX Processor's Status**

The indicator lights on the front of a DMX Processor 8000 display its status on the network.

Light	On	Blinking	Off
Status	Connected to a show	Connecting	Not Connected to a show
DMX Data	DMX Data output	2Hz Keep Alive	No DMX sending
Net Data	Art-Net output	Art-Net configured, but not connected	Art-Net not configured
USB	USB Device connected and active	USB Device found but not configured	No USB Device found
HogNet	Link light for HogNet connection	HogNet activity	HogNet not connected
FixtureNet (Art-Net)	Link light for fixture connection	Fixture activity	Fixture not connected
Write	Writing flash memory	<i>Fast:</i> bootloader active <i>Slow:</i> updating firmware	Normal activity

3.3 HogNet Network

On the back of every Hog 4 OS console is a dedicated Base-T Ethernet jack that can be used for connecting to a network of DMX Processors, computers, and other consoles. If there is more than one Ethernet jack on the back of the console, then the jack labeled HogNet should be used. The Ethernet jacks on some HedgeHog 4 and Road Hog 4 consoles may not be labeled in which case the HogNet port is the Ethernet jack on the RIGHT when viewing the console from the rear (see backpanel drawing below) The hardware on personal computers running Hog 4 PC will vary but at least one 100 Base-T Ethernet hardware device must be properly installed and enabled in order for Hog 4 PC to successfully communicate to other nodes on a network.

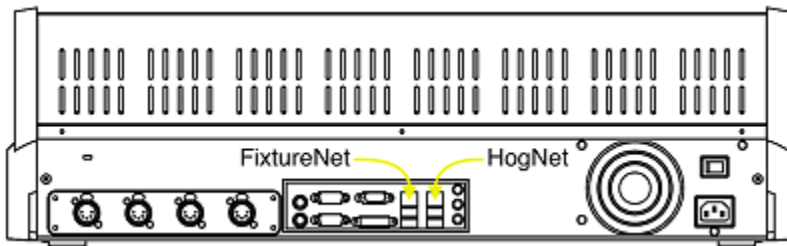

Figure 3.8. HogNet and FixturerNet Connections on back panel of Road Hog 4 Console

All components of a Hog network should be connected using category 5 Ethernet cables and using at least a 100mb Ethernet switch or router. Gigabit switches are also HogNet compatible.

The simplest HogNet network consists of a console and a DMX Processor connected to the lighting rig. Only slightly more complex is the case of a system with a single console and several DMX Processors connected together with an Ethernet switch. Large systems

can have several consoles, Hog 4 PC systems, and DMX Processors, controlling large lighting rigs.

3.3.1 Configuring Console Network Adapters

At the top of the HogNet tab in the Control Panel, is a drop down menu of all the installed network adapters usable by the Hog OS. The Hog 4 console will only list one network adapter and it will be greyed out while Windows computers running Hog 4 PC might have more than one network adapter listed depending on how many network adapters are installed and enabled on the computer.

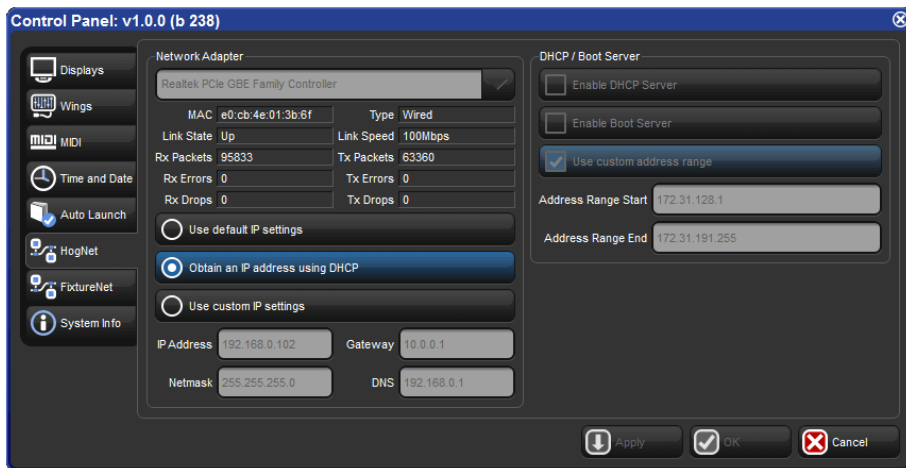

Figure 3.9. The Network pane of the Control Panel

After selecting one adapter from the drop down menu, the area below the menu will show the adapter's current status:

- A link status of Up indicates the adapter is connected to a network and is ready to be configured to communicate to other network devices.
- A link status of Disconnected indicates the adapter is running but is unable to communicate to other nodes because the network cable is not connected to a network.
- A link status of Down indicates the adapter is either disabled or in an unstable state and is not usable for show operation.



Important

Only network adapters with a link state of UP will be able to communicate with other nodes on the network. If none of the listed adapters are in the UP state then the Hog 4 OS will not operate on a network and will instead operate as a standalone console using a loopback address.

Configuring an IP Address for the HogNet Network Adapter

In order for a network adapter to properly communicate on a network it must be configured with an IP address setting that is compatible with other devices on the network. There are three main options when configuring an IP address for a HogNet adapter:

Default IP address: select this option to use an IP address of 172.31.0.1.

Obtain an IP address using DHCP: select this option when running the console on a network that contains a DHCP server such as a DHCP router or a Hog console running a DHCP server.



Important

If you choose to obtain an IP address using DHCP on the console and no DHCP server is present on the network, then the console will revert to a loopback address of 127.0.0.1 which is not a usable network address for network show operation. In this case you should use a custom IP address.

Custom IP address: This option allows you to specify the IP address and subnet mask settings of the Console. This option is most commonly used on networks where a DHCP server is not present but multiple unique IP addresses need to be specified.

Enabling the DHCP Server

In addition to being DHCP client compatible, all network enabled consoles are also capable of running a DHCP server themselves. Enabling DHCP allows the console to hand out IP addresses to other consoles, DMX Processors, and computers on the network without needing to manually configure static IP addresses for every device on the network.

Choosing BOOT Server ONLY

Included in the DHCP server options of the console is the Boot server. The Boot server process is separate from the DHCP server and is used by Hog consoles to provide remote software imaging for the DMX Processor 8000. You can select options to either run only a Boot server (with or without a custom address range) or to run both a Boot server and a DHCP server. When running both, the custom address range applies to both the DHCP server and the Boot server.

Using a Custom DHCP Server Range

Sometimes in more complex networks where more than one DHCP server is present, specifying a custom DHCP server range is necessary to avoid IP address conflicts. Using a custom DHCP address range applies to both the DHCP server and the Boot server processes. To use a custom DHCP range on your console enable the Use custom address range button and specify the start and end addresses in the fields below the button.

Firewalls and Hog 4 PC

Firewalls help to provide increased network security by controlling access to private networks and computers based on the public IP address of the client. Since the Hog 4 OS depends on multi-cast network traffic for communication to other system devices it is encouraged that users configure their network and computer firewalls and security settings to allow for HogNet network traffic. For some firewall applications this might mean turning off the firewall completely.

Configuring HogNet Network Settings on a DMX Processor

In the front panel menu system of the DMX Processor 8000 is a network configuration menu used to configure IP address settings for that particular node. This menu can be accessed by first selecting Network, HogNet, HogNet Config.

Configuring the IP addresses and subnet addresses on Hog processors follow the exact same rules and principals as outlined for network adapters consoles in *Configuring Console Network Adapters* (p.64)

Typical HogNet Network Configurations

Example A: A single console and single DMX Processor.

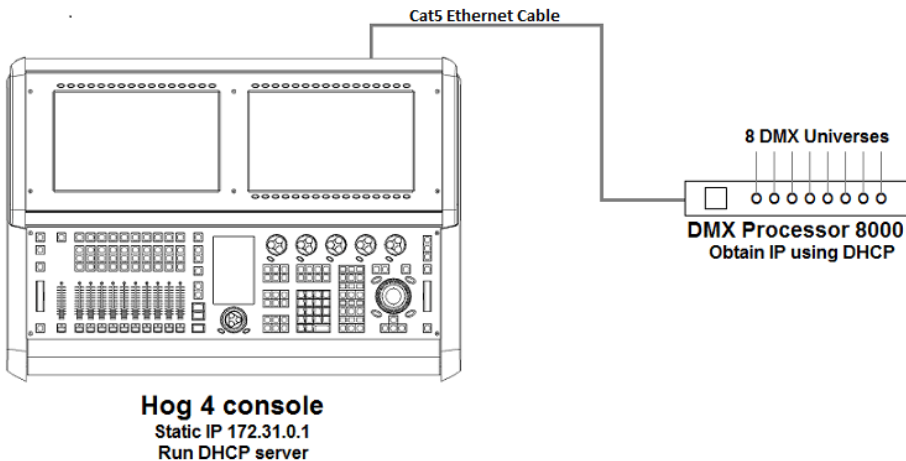

Example B: The console is a DHCP server, and all other nodes obtain an IP address from it.

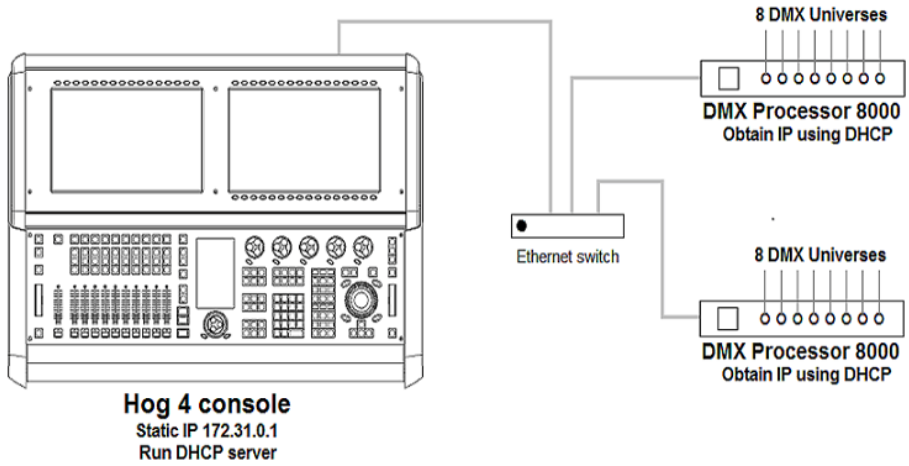

Example C: A DHCP Router serves all components.

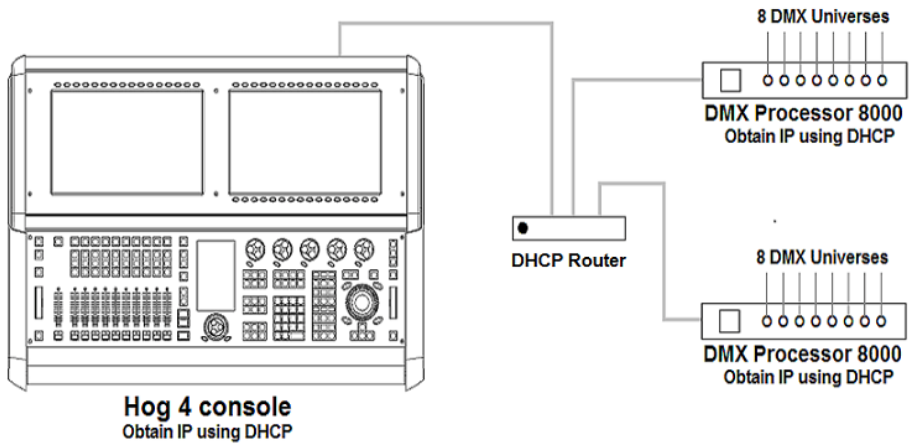

Example D: All components have a custom unique static IP address.

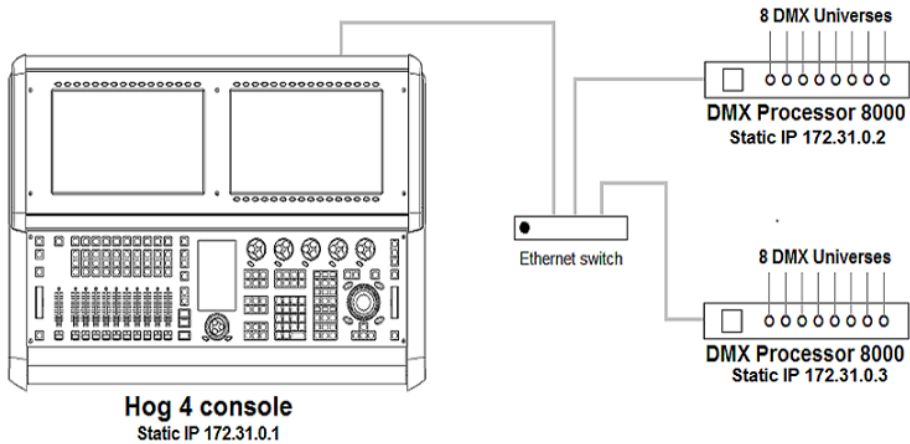

3.3.2 Port Number

Since multiple shows can be run on a single network, each show server running on the network must have its own port number to keep lighting data for each show on the network separated. Nodes connecting to the show server must then have the same port number as the show server console. For example, a console running a show server on the network on port 6600 means other nodes such as DMX Processors on the network will need a port number of 6600 as well to join that same show.

3.3.3 Node Types and Net Numbers

There are two elements that help to identify a node's role in a network show: node type and net number. The node type is inherent to device hardware and cannot be changed. For example, a Hog 4 is a "console" node type while a DMX Processor 8000 is a DMX Processor node type. Secondly, there is the device's net number. The net number is a user-configurable setting that further defines the node's role in a network show. For example, a DMX Processor 8000 set to net number 1 means the DMX Processor 8000 will load and output patch information stored in the show file for DMX Processor 8000 #1.



Important

Within a single node type each device must be set to a unique net number. For example you cannot set two physical DMX Processor 8000s to net number 1 in a show. Only one of the DPs will actually load show data while the other DP will sit idle as a duplicate. Consoles are the only exception to the duplicate net number rule. Individual consoles can be set to identical net numbers which allows them to fully track one another in terms of their current page,

chosen master, and playback state. This “tracking” feature, when combined with the fail over functionality discussed in *Configuring the Network for Console Fail over (p.70)* provides the user with the ability to configure a tracking backup console on the network.

3.3.4 Connecting Multiple Consoles

Multiple Hog consoles can be connected together in various configurations when running on the same port number. Client/Server configuration allows multiple users to program on the same show file. Console Fail over provides network backup of two or more consoles running the same show. Console Tracking creates redundancy of all console functions across multiple consoles. You should link all consoles and network devices to an Ethernet switch using certified Category 5 non-crossover cables.

3.3.5 Configuring the Network for Client/Server

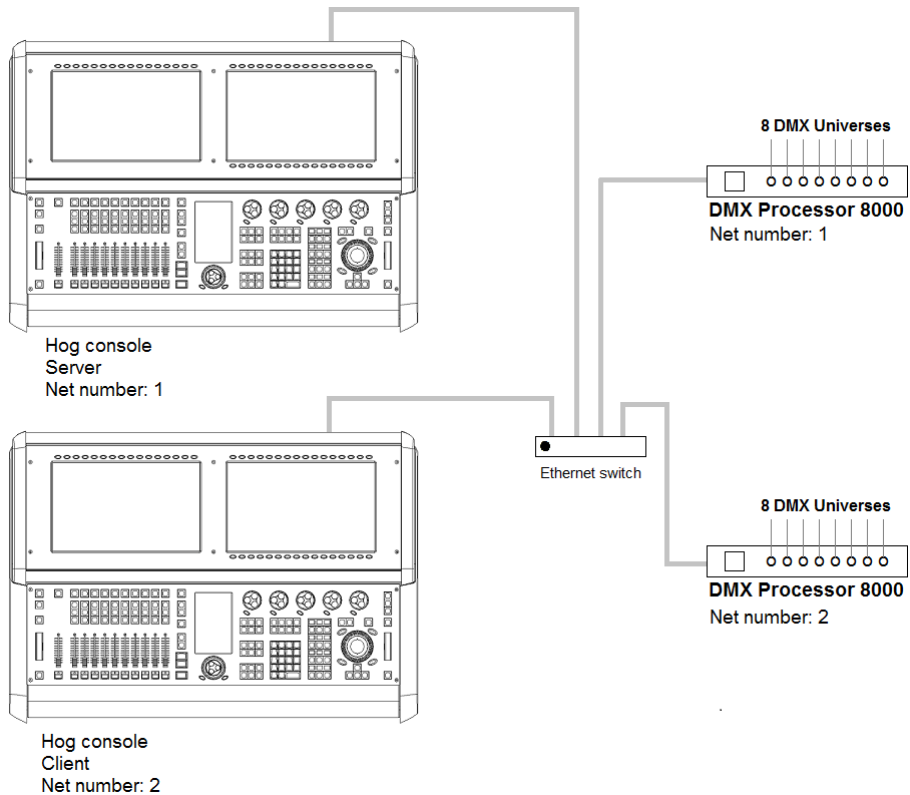

Running the Console as a Show Server

When the Run Server option in the Settings window of the start screen is checked, the console is enabled as a show server. A show server console is able to do three main things that it would not otherwise be able to do as a client:

1. Start New Shows
2. Launch existing shows from disk
3. Connect to and sync a local copy of show data from other show server consoles on the network.

Since consoles that are enabled as show servers continuously sync and store local copies of show data during programming, setting up more than one show server in your network allows for continued show operation should one console fail. This method of redundancy is called “fail over”. See *Configuring the Network for Console Fail over (p.70)*

Running the Console as a Client

When the Run Server option in the Settings window of the Start screen is not checked, the console will operate only as a client to other show server consoles on the network. As a client, the console will not keep a local copy of the network show file and as a result will be forced to log off the connected show session if all show servers running on the network are logged off.



Tip

The generic word *server* is often mentioned when working with a Hog 4 OS system. There are three types of servers that are at work in a networked Hog show. The DHCP server manages IP address assignments to other consoles, nodes, and computers on the network through the use of Dynamic Host Control Protocol (DHCP). A Show server refers to the server process running on the console, which manages show data and distribution. The DHCP server and the Show server are independent of one another and do not need to be running on the same console. The Boot server process is used by Hog consoles to provide remote software imaging for the DMX Processor 8000.

3.3.6 Configuring the Network for Console Fail over

When two or more show server consoles are connected to a network show, a feature known as fail over is automatically enabled, allowing for one of the consoles to “fail” without causing a loss of control over the show data or dmx output. Each show server on the network has the ability to take over control of the show should one of the other show server consoles suffer from power loss, a severed network connection, or localized failure. Users are encouraged to run at least two networked show server consoles in live performance situations in the event that, if one console fails, the show can remain running on the secondary console while the first console is recovered.

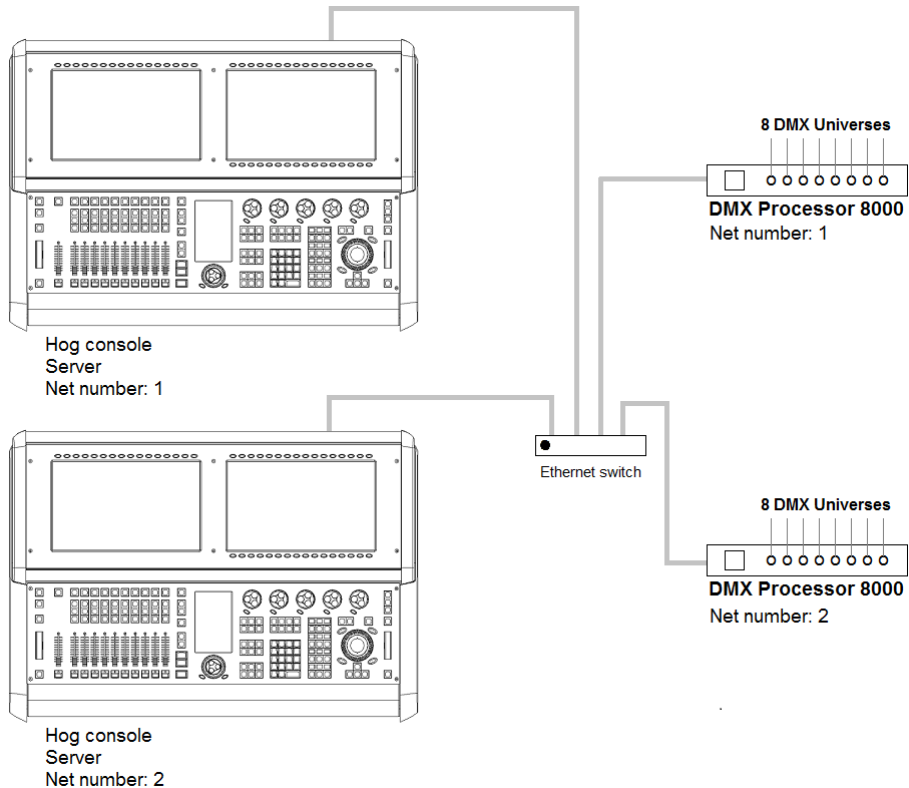

To enable console fail over:

1. Connect two consoles via an Ethernet switch.
2. Enable the Run Server option in the Settings window on each console.
3. Configure the primary console as Net number 1 and the secondary console as Net number 2.
4. Log on primary console and then connect secondary console.

After configuring the network for fail over, each console connected to the show will monitor the status of the primary console (the console that first loaded the show on the network) for any failures or forced log offs.

In the event that the primary console suffers a critical error or is disconnected from the network, all other consoles connected to the show will post the message shown below, notifying the user that a fail over has occurred and indicated which of the other server consoles has taken over as the active show server (primary console).

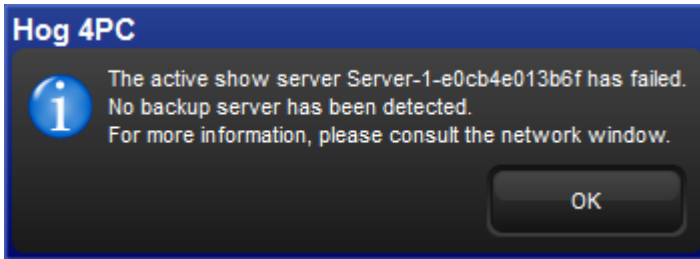

If you see this message, first check to see if the original primary console is still physically connected to the network, then power cycle the original primary console and reconnect it to the show.

In the event that the console operator intentionally logged off the primary console, all other consoles connected to the show will post the fail over message shown below to indicate that the primary server console has logged off and another server console has assumed the role as the active show server (primary console).

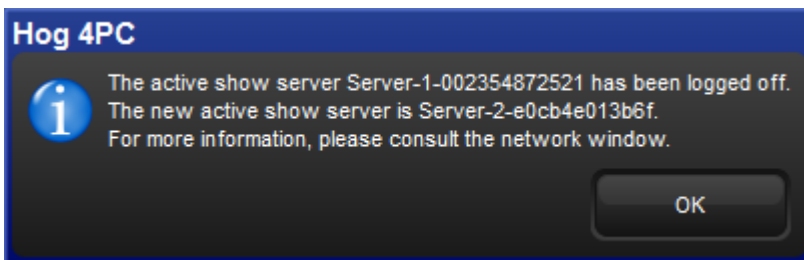

Since this message is the direct result of the primary console being willfully logged off from the show there is no need to perform any troubleshooting. Simply reconnect the logged off console to the show and it will once again participate as a show server console on the network.

Understanding Multi-Server Fail over Behavior

Below are some specific rules and examples that describe how the Hog 4 OS works when setup in a Multi-Console / Multi-Server environment:

1. The server that initially launches a show is the active server. Other servers that join the show are backup servers. The active server replicates it's copy of the show to all backup servers as they join the show, replacing any existing copy of the show on the backup servers.
2. If all servers stay connected to the network and remain visible to each other, then all servers will have the same copy of the show. New data created on any console will immediately replicate to all servers.
3. If any server logs off, then the remaining servers will continue to store the show and can replicate the show to new consoles that log on. As long as at least one server is always available, then consoles can log off and log on at will.

4. If any server logs off the show and later rejoins, it will always rejoin as a backup server, and the active server will replicate it's current copy of the show to the backup.
5. If all servers log off at the same time then any server can initially launch the show, since all servers will have the same data. However, the last server to shut down will also clean up the database, so it's preferable that this be the initial server when starting up next time. So it's preferable to designate a single console to store the "master" copy of the show, and ensure it's always the first server to start and the last server to shut down.
6. If some servers log off, then new data continues to be replicated to the remaining servers. If all servers then log off, some consoles will have newer data (the consoles that remained logged in), and some will have older data (the consoles that logged off early). Launching a server using an older copy of the show makes that the active server, and any servers that then join will be backup servers and the old data will be replicated to them. That includes servers that may have had a newer copy of the show. So here is one way that new show data may be lost, replaced with old show data from a console that never saw it.

Understanding Multi-Server Partitioning and Rejoining

1. All servers in a networked show constantly check for connectivity to each other. If connectivity is broken for more than a few seconds, the servers consider themselves isolated from the servers they can't reach. This is called a partitioned network. The servers within each partition will continue to replicate changes amongst each other, so newly created data will be replicated amongst all servers in a partition. However, since there are multiple partitions that can't communicate with each other, there are multiple (different) copies of the show.
2. A partition can happen very easily. For example, by disconnecting a server's network cable for a few seconds, then reconnecting it, it will be partitioned from the rest of the servers.
3. Even after a severed network connection is repaired and connectivity is restored to all servers, they will still artificially remain partitioned. There is no way to automatically merge different copies of the show. There simply is no way for the software to know which copy of the show is "correct", since conflicting changes may be made within each partition. Since Hog 4 OS can't automatically resolve the differences, the servers artificially maintain the partition. So each partition's copy of the show is maintained only within that partition, and new data is only replicated within each partition.
4. Although the partitions are artificially maintained, all consoles will continue to have control over all aspects of the show that they have connectivity to.
5. Logging a console off a show and rejoining allows that console to rejoin a partition it was previously excluded from. If multiple partitions exist, there is no guarantee which partition it will join.
6. After shutting everything down, different consoles will have different data, based on the partition they were in. Copies of the show from a partition that didn't see any changes will essentially be "old". Changes made in other partitions will be saved on those consoles,

but they may be considered backup/client consoles, and thus they are not expected to store the master copy of the data.

7. Data loss is a real risk if the master server is briefly disconnected from the other consoles then reconnected. In this case it will remain artificially partitioned from the other consoles, even though it will be shown as online in the Network Window. New data created on your consoles will be replicated amongst those consoles (since they have their own partition), but the master server won't see any of it since it stays isolated in its own partition. After logging off all consoles, their partition is gone, and they will each have a current copy of the show with all new changes. The master server will have an old (unmodified) copy of the show. If it's rebooted and it initially launches the show, it will still be using it's old copy. The consoles can now rejoin the master server, but their current copy of the show will be replaced with the old show from the master server.

8. To avoid data loss, it recommend that users log off every console/server that's NOT in the partition that has (or will have) the current copy of the show. So in the above case, the only recourse is to leave the consoles online, log off the master server, and log on the master server to the show. It will then replicate the current show from the consoles.

3.3.7 **Configuring the Network for Console Tracking**

Console tracking allows two or more consoles to track each other in terms of the chosen page, the chosen master, and playback state while still maintaining individual desktop/programmer experiences between the desks. A backup secondary networked show server console set to the same net number as the primary console is recommended when setting up Hog control systems for live shows. This creates system redundancy and protects from total loss of control should the primary console fail.

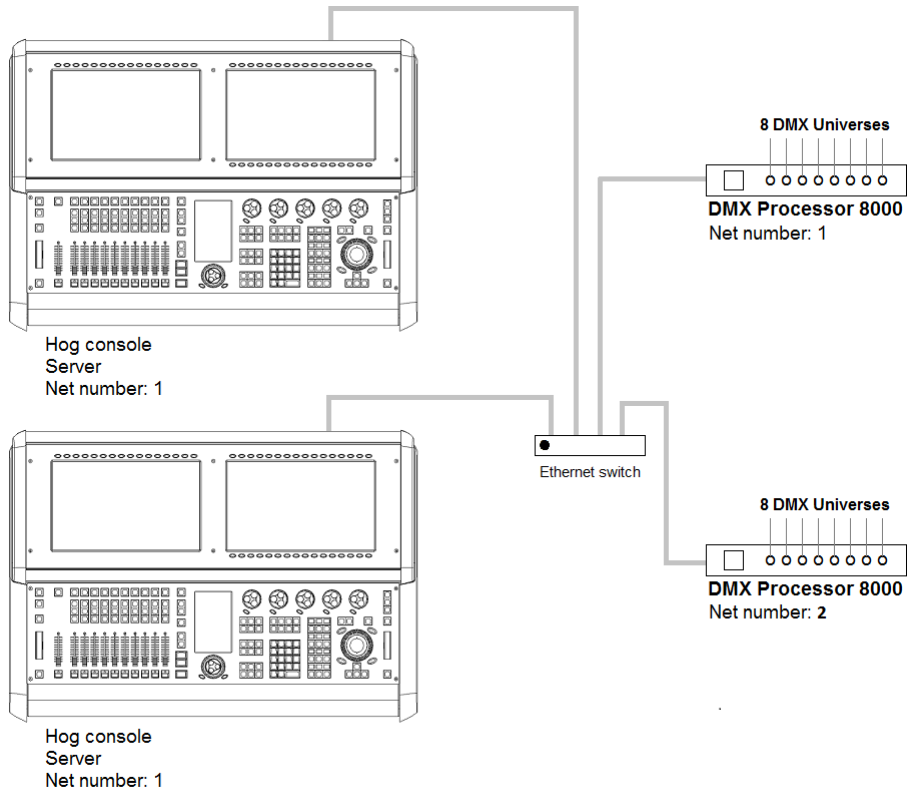

To enable Console Tracking:

1. Connect two consoles via an Ethernet switch.
2. Enable the Run Server option in the Settings window on at least one of the consoles. You can choose to enable the Run Server option on both consoles to also engage fail over functionality.
3. Set both consoles to Net number 1.
4. Log the primary console to a show and then connect the secondary console to the same show.

The two consoles will now mirror each other in terms of chosen master, current page, and playback state.

3.3.8 More than One Show on the Network

If you want to run more than one show on the same network, you need to choose a port number for each show. The default port number is 6600, so the second show could be

on 6601, the third on 6602, and so on. You need to assign the port number of each console system and network device according to the show it is used with.

3.3.9 Connecting to an Existing Network

You can connect the console to an existing Ethernet network if desired. Contact the administrator of the network to obtain the correct network settings.



Important

You should disable the DHCP server of the console before connecting to an existing computer network, otherwise it may interfere with the correct operation of the network.

3.3.10 Network File Sharing

You can connect to drives on a local network or remote computer to transfer show files. Only compressed show file backup (.tar.gz or .shw) files can be transferred with Network File Sharing.

Mapping Network Drives

Network drives are available within the Start window and the Backup window.

To map a network drive:

1. Connect a remote computer or network to the HogNet network.
2. Click the Browse button in the Start or Backup window.
3. Click on the Map Network Drive

 button.
4. Enter data for the following fields in the Connect to Network Disk window:
 - **Server name:** the host name or IP address of the remote computer
 - **Share name:** the name of the shared directory on the remote computer
 - **Username:** the user name to access the shared directory on the remote computer (if required)
 - **Password:** the password to access the shared directory on the remote computer (if required)
 - **Domain:** if the user account is a member of a windows domain, enter that domain name here, otherwise leave this field blank.

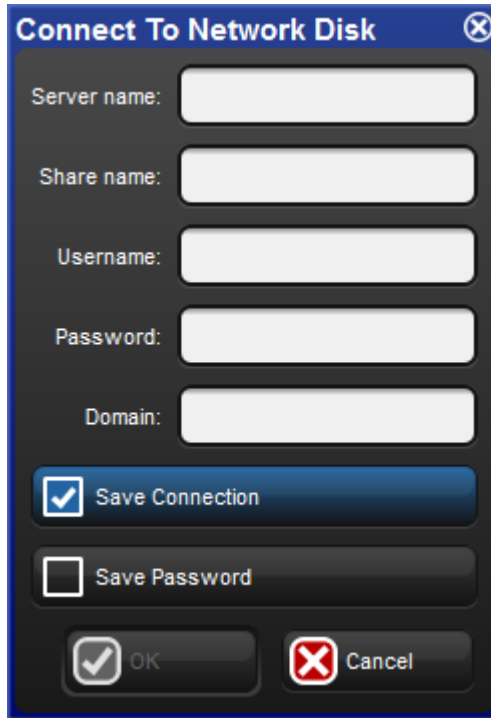

Note that depending upon your network drive configuration, not all fields may be required.

5. Check the box if you want the connection to be saved with the console. If this option is *not* selected, then this mapping will be lost when the console is rebooted or power cycled.
6. Check the box to save the password if you wish to have the password for the drive mapping saved with the above option.

Accessing Network Drives

Once a network drive is mapped, it will appear in the Start and Backup windows under the console heading as a valid drive to browse to. Sub folders of the primary networked drive will also be available.

Disconnecting Network Drives

When browsing a network drive, the Eject



button is available in the top right corner of the browse window. Pressing this button will un-map and disconnect the network drive.

3.4 Art-Net and E1.31(sACN)

Art-Net and E1.31 (also known as streaming ACN) are two communication protocols supported by the Hog 4 OS that allow for DMX512 data to be sent over Ethernet. While each protocol is unique in terms of specification and implementation, they both provide the ability to carry many DMX universes over a single cat 5 Ethernet cable. This section of the manual will help you to understand how to properly configure your console or Hog 4 PC to output Art-Net and E1.31.

Platform	Art-Net / sACN Output Capability
Hog 4-18 Console	16 unique universes
Hog 4 Console	16 unique universes
DMX Processor 8000	16 unique universes
Full Boar 4 Console	12 unique universes
Road Hog 4 Console	8 unique universes
HedgeHog 4x	6 unique universes
HedgeHog 4	4 unique universes
Hog 4 PC	12 unique universes **

** ArtNet and sACN output for a Hog 4 PC universe is enabled by connecting and mapping a DMX widget and/or an ETCNomad license key to the dmx universe.

3.4.1 Identifying the FixtureNet Port

The FixtureNet port is the Ethernet port Hog 4 OS uses to send Art-Net and/or E1.31 data to fixtures, media servers, and DMX converters that are capable of receiving these protocols over Ethernet. The FixtureNet port is located on the rear panel of the console as well as on the rear panel of the DMX Processor 8000. Depending on the age of your DMX Processor 8000 the port will either be labeled FixtureNet or Fixture Link.

When using Hog 4 PC you have the option to select which of your computer's network adapters will act as the FixtureNet port for outputting Art-Net and/or E1.31.

To assign one of your computer's network adapters to act as the Hog 4 PC FixtureNet port:

1. Control Panel → FixtureNet
2. Select a network adapter from the list of available adapters at the top of the window. If only one network adapter is available then it will be selected automatically and the drop down box will be greyed out. If no network adapters are available the drop down menu will be blank and greyed out.



Important

Hog 4 PC will only output Art-Net and sACN for universes 1 thru 8 and a USB DMX Widget must be connected and assigned to the matching universe.



Important

It is recommended that you do *not* combine HogNet and Art-Net or E1.31(sACN) within the same network. This can produce network errors and unreliable data. When using Hog 4 PC you have the ability to assign both HogNet and Art-Net/E1.31 to a single adapter but using separate network adapters is strongly advised.

3.4.2 Configuring the FixtureNet Port

In order to successfully output Art-Net or E1.31 from your Hog 4 console, DMX Processor 8000, or Hog 4PC, you must first properly configure the FixtureNet's IP address to settings that are appropriate for your network.

To configure DMX Processor 8000's FixtureNet from the DP8000 front panel:

- Network → Fixture → FixtureNetConfig

To configure DP8000's FixtureNet from the console:

1. Setup → Network : open the Network window.
2. Select the DMX Processor 8000 and press Settings.
3. Select the FixtureNet pane of the DMX Processor Settings window;

To configure the Hog 4 console or Hog 4 PC's assigned FixtureNet port from the console:

1. Setup → Network : open the Network window.
2. Select the DMX Processor 8000 assigned to net number 1 (or whichever DMX Processor is associated with the local internal DMX Processor 8000 in your show) and press Settings.
3. Select the FixtureNet pane of the DMX Processor Settings window.

From these configurations menus you can configure the FixtureNet's IP address (source address) in one of two ways:

- **Obtain an IP address using DHCP:** select this option when running the Art-Net side of the console on a network that contains a DHCP server such as a DHCP router. When using DHCP, the IP Address, Netmask, and Gateway fields will be grayed out. The information contained with them is not relevant to the DHCP configuration.



Important

If you select Obtain an IP address using DHCP on the console and no DHCP server is present on the FixtureNet network then the FixtureNet adapter will revert to a loopback address of 127.0.0.1.

- **Use Custom IP Settings:** This option allows you to specify the IP address and subnet mask settings of the FixtureNet adapter. This option is most commonly used on networks where a DHCP server is not present. Once selected you will need to enter the IP Address, Netmask, and Gateway for this device on the network.

3.4.3 Configuring Art-Net Output

Art-Net output is configurable using the Art-Net Outputs pane of the DMX Processor Settings window.

1. Setup → Network : open the Network window.
2. Select the DMX Processor 8000 and press Settings.
3. Select the Art-Net Outputs pane of the DMX Processor Settings window, see *Figure 3.10, “Art-Net Outputs pane of the DMX Processor Settings window”*.
 - **Universe:** this field denotes which DMX universe to configure.
 - **Broadcast:** check this box to enable Broadcasting. When enabled, all Art-Net information will be sent to all nodes.
 - **UnicastIP:** when the Broadcast field is not checked, enter an IP address of an Art-Net node to Unicast the universe’s data to.
 - **Subnet:** click to select the Art-Net subnet (0-15) to transmit this universe’s data on. By default, the subnet will match the Node number of the DMX Processor 8000.
 - **Universe:** click to select the Art-Net Universe (0-15) to transmit this universe’s data on.
 - **Changes Only:** check this box to transmit only changes to Art-Net data.
 - **-/+ :** click these keys to expand or reduce the number of Art-Net configurations for a specific DMX universe.

3.4.4 Configuring E1.31(sACN) Output

E1.31 Output is configurable using the E1.31 pane of the DMX Processor window.

1. Setup → Network : open the Network window.
2. Select the DMX Processor 8000 and press Settings.



Figure 3.10. Art-Net Outputs pane of the DMX Processor Settings window

3. Select the E1.31 pane of the DMX Processor Settings window, see Figure 3.11, "E1.31 pane of the DMX Processor Settings window".
 - **Universe:** this field denotes which DMX universe to configure.
 - **Multicast:** check this box to enable Multicasting. When enabled, all E1.31 information will be sent to all nodes.
 - **Destination IP:** when the Multicast field is not checked, enter an IP address to Unicast E1.31 data to.
 - **Universe:** click to select the E1.31 Universe to transmit this universe's data on.
 - **Changes Only:** check this box to transmit only changes to E1.31 data.

E1.31 supports two styles of priority. The first is a per-universe priority that defines a single priority for all of the slots within the universe. The second style, per-slot priority, allows a separate priority be assigned to each individual slot within that universe. Not all E1.31 receivers support per-slot priority. On those receivers that support per-slot priority, the per-universe priority will be ignored when per-slot priority is enabled.

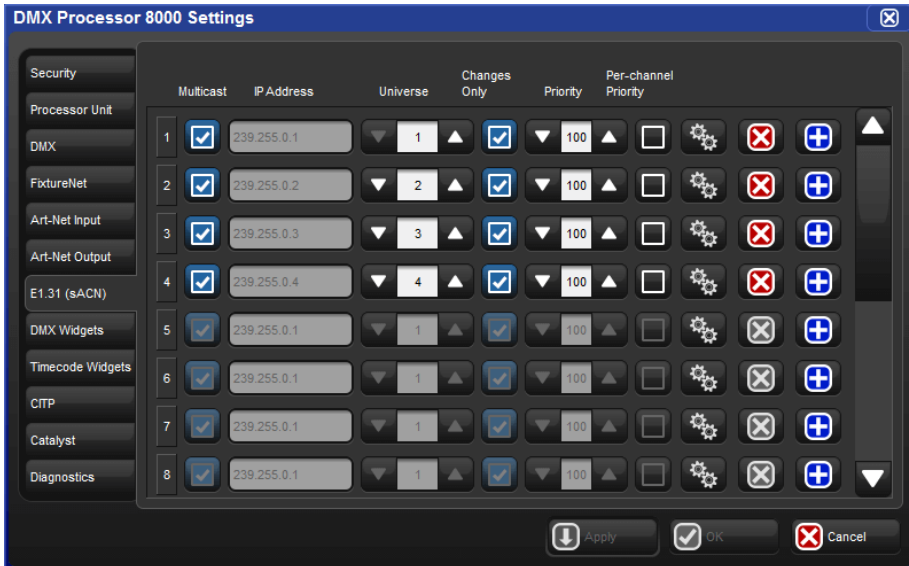

Figure 3.11. E1.31 pane of the DMX Processor Settings window

- **Priority** :: click to the per-universe priority for the E1.31 data being sent for that universe of data. Valid settings range from 0 to 200, with higher numbers representing higher priority.
- **Per Slot Priority** :: click on the Enable button to enable per-slot priorities for the universe. Click on the Configure button to set the per-slot priority values for individual slots within that universe. Valid settings range from 0 to 200. Higher numbers represent higher priority. A slot priority of 0 indicates that the slot should be ignored.
- **-/+** : click these keys to expand or reduce the number of E1.31 configurations for a specific DMX universe.

When E1.31 is configured and fixtures are patched, the Net Data LED on the DMX Processor 8000 will illuminate to indicate E1.31 Output.

3.5 Adding Playback Wings

The physical playback controls of all Hog 4 Series consoles (including Hog 4 PC) can be expanded through the use of external USB playback wings.

The following playback wings are supported:

- PlayBack Wing 4 - 10 masters / motorized faders / play, pause, play backwards, flash, skip fwd/bck controls / 15.6" touchscreen display

- MiniWing 4 - 10 masters / manual faders / play, pause, flash, and skip fwd/bck controls
- Master Wing 4 - 30 fader-less masters / play, flash, skip fwd/bck controls / 15.6" touchscreen display
- Hog 3 Mini Playback Wing - 10 masters / manual faders / play, pause, flash, skip fwd/bck controls
- Road Hog 3 / Full Boar 3 Playback Wing - 10 masters / manual faders / play, pause, flash, skip fwd/bck controls / 12" touchscreen display

To attach a playback wing to the console:

1. Apply AC power to the wing and connect the wing to the console via USB.

For wings with a display, connect the DVI or VGA port on the back of the wing to one of the Console's display outputs. An adapter may be required.

2. Setup → Control Panel → Wings : open the Wings pane of the Control Panel window (see *Figure 3.12, "Wings pane of the Control Panel with active front panel and wing docking assignments"*).
3. Use the Docking Assignment drop down menus to assign the playback wing's ID number to one or more playback bars.
4. Press the Dock button to activate a playback bar's docking assignment.

Docking a playback bar to its docking assignment can also be accomplished by holding the center Choose key on the console front panel and pressing the number on the numeric keypad that coordinates with the playback bar. For example, to dock Playback Bar 1 press and hold the center Choose key and then press the 1 key on the numeric keypad.

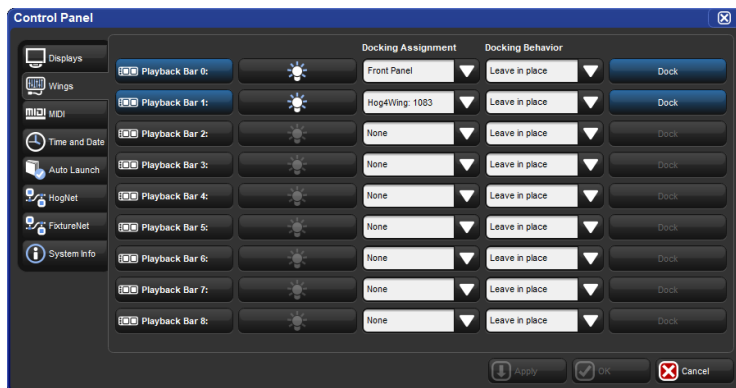

Figure 3.12. Wings pane of the Control Panel with active front panel and wing docking assignments

5. To show/hide a playback bar on the desktop, toggle it's button in the Control Panel. Playback Bars can also be shown/hidden on the desktop by holding the Pig key and pressing the number on the numeric keypad that coordinates with the playback bar. For example, to show/hide Playback bar 1 press and hold the Pig key and then press the 1 key on the numeric keypad.
6. Once a playback bar is displayed on the desktop it can be enhanced to show more information. Right click on a playback bar to display the following options:
 - Hide Playback Bar: completely hides the playback bar from the desktop. Show/hide settings for playback bars are stored per physical console; not per show.
 - Beacon Wing: flashes the choose keys of the wing assigned to the playback bar.
 - Align Hog4Wing: aligns the playback bar's masters to match the physical layout of a Playback Wing 4 or Master Wing 4. This option is stored per playback bar, per show.
 - Toggle Dock Indicator: toggles on/off a dock button on the playback bar. This option is stored per playback bar, per show and is turned off for new shows.
 - Toggle Header: toggles on/off a header row that displays the playback bar's number and docking assignment. When the header is displayed in bold white text, the docking assignment is active. When the header text is displayed in regular grey text, the docking assignment is NOT active. This option is stored per playback bar, per show and is turned off for new shows.
7. For wings with a built-in display: use the Displays tab of the Control Panel to configure the console's external monitor output settings.

NOTE: The Full Boar 4's DVI-D monitor output connections do not support analog output to VGA displays such as those featured on the older Full Boar 3 playback and programming wings.

3.6 Virtual Playback Wings

To display a Virtual Wing Window on the console:

1. Press and hold the touchscreen to bring up the menu window press the Virtual Wing button in the menu window -OR- Hold the open key and select virtual wing from the main toolbar.

2. Use the scroll box at the top of the Virtual Wing Window to assign a playback bar to the Virtual Wing Window.
3. To adjust which physical controls are displayed in the Virtual Wing Window click on the



button. All Virtual Wing window settings are stored per window and can be stored/recalled in views.



Figure 3.13. The Virtual Wing Window

3.7 High End Systems USB DMX Widgets

The High End Systems USB DMX Widgets listed in the table below are supported by all Hog 4 OS Consoles, Hog 4 PC, and DMX Processor 8000.



High End Systems USB DMX widgets can be mapped to any of the DMX universes being processed by the hardware platform it is connected to.

The table below shows the number of DMX universes processed by each hardware device. Multiple widgets can be connected and mapped to these dmX universes.

Hardware Platform	DMX Processing Capability
Hog 4-18	16 Universes
Hog 4	16 Universes
DMX Processor 8000	16 Universes
Full Boar 4	12 Universes
Hog 4 PC	12 Universes
Road Hog 4	8 Universes
HedgeHog 4X	6 Universes
HedgeHog 4, 4N, 4S	4 Universes

Mapping a High End Systems USB DMX widget to a DMX universe provides two benefits:

1. Physical 5-pin DMX output for the universe
2. Unlocks Art-Net & sACN output for the universe (Hog 4 PC Only)

To connect and map a High End Systems Widget:

1. Connect the DMX widget via USB to a Hog Console, Windows PC, or DMX Processor.
2. Start a new show or launch an existing show on the console.
3. Setup → Network; opens the Network window.
4. Click on the DMX Processor to which the DMX widget is attached. (this is most likely DMX Processor #1)
5. Press the Settings button at the top of the network window to open the DMX Processor Settings window.
6. Select the “DMX Widgets” pane in the DMX Processor Settings window.
7. Press the blue plus button on any DMX universe to add a DMX widget mapping.
8. Use the widget drop down menu to select the [serial number, output port] of the widget you want to map to that universe.
9. Optional: If more than one dmx widget is plugged in, pressing the Beacon button to the right of the mapping can help identify which widget has been mapped.
10. Click OK or APPLY to confirm the mapping. All of the widget's status LEDs except for "RX Mode" should now be illuminated and the widget should be outputting dmx.

3.7.1 High End Systems DMX Widget Status LEDs

LED	On	Slow Blinking	Off
TX Mode	widget is transmitting dmx	not implemented	widget is not transmitting dmx
RX Mode	not implemented	not implemented	not implemented
DMX OK	widget is outputting dmx	widget has lost connection to active DP and widget is transmitting DMX at a 2HZ keep alive refresh rate	widget is not outputting dmx
Active	widget is mapped and connected to an active DP	not implement	DMX widget is not mapped to an active DP
Link	widget has loaded its firmware	not implemented	widget has not loaded its firmware

3.8 ETC Gadget II with ETCnomad Key

The following ETC USB devices are supported by Hog 4 OS Consoles and Hog 4 PC:

Device Name	ETC Part Number
Gadget II	4267A1004
ETCnomad Minimum Key (2 Hog Universes)	4380A1011
ETCnomad Maximum Key (12 Hog Universes)	4380A1037

The ETC Gadget II is a two port DMX output device that can be mapped to any of the DMX universes being processed by the console (or Hog 4 PC) to which it is connected. The ETCnomad Key is small security device that plugs into one of the USB ports of the console or PC and is needed for licensing Gadget II's outputs. Therefore both devices are required for proper Gadget II operation with Hog 4 Consoles and Hog 4 PC.

To properly connect and map an ETC Gadget II with an ETCnomad Key:

1. Boot the console to the start screen (or launch Hog 4 PC to the start screen).
2. Connect the Gadget II via USB to the console or PC. (Gadget II is not compatible with external DMX Processor 8000).
3. Connect an ETCnomad Key to the same machine as the Gadget II. Stacking ETCnomad keys is not supported.
4. Start a new or launch an existing show file.
5. Opens the Network window (Setup → Network)
6. Click on the local DMX Processor. (this is most likely DMX Processor #1)
7. Press the Settings button at the top of the network window to open the DMX Processor Settings window.
8. Select the "DMX Widgets" tab in the DMX Processor Settings window.
9. Press the blue plus button on a DMX universe to add a Gadget II mapping.
10. Use the widget drop down menu to select one of the Gadget II outputs. If the Gadget II is listed in the menu as "needs license" then a proper ETCnomad key has not been discovered and the Gadget II will not output proper DMX.
11. Click OK or APPLY to confirm the mapping. The Gadget II's status LEDs should now be flashing green.

When a Gadget II device is connected, the lowest numbered ETCnomad Key output mappings are displayed as Gadget II # Output # instead of ETCnomad Key # in the widget drop down menu. This is because the key is licensing Gadget II outputs. For

example, let's say you are using two Gadget II devices in conjunction with an ETCnomad Maximum Key. In this case the widget drop down menu will populate with four licensed Gadget II outputs plus ETCnomad Key Outputs 5 thru 12. ETCnomad Key 1 thru 4 is not shown because they are now synonymous with the Gadget II outputs.



Tip

If a Gadget II or ETCnomad key device is not functioning properly then un-map the device, reboot the computer, and try again.

3.8.1 Gadget II Refresh Rates

Gadget II outputs DMX at the refresh rates listed in the table below when operated with Hog 4 OS consoles and Hog 4 PC.

DP8000 Refresh Rate	Gadget II Output
10 < 25 Hz	19 Hz
26 < 29 Hz	27 Hz
30 < 35 Hz	34 Hz
36 < 40 Hz	40 Hz

3.8.2 Gadget II Status LED

LED	Status
Solid Red	Device is Enumerating USB
Solid Green	USB is Enumerated / Firmware OK
Blinking green	Receiving commands from the USB Host
Slow Blinking Red	awaiting firmware from host computer
Rapid Blinking Red	loading firmware from host computer

3.9 Hog 4 PC with ETCnomad Key

When an ETCnomad Key is connected to a computer running Hog 4 PC the key can be mapped to the local DP's DMX universes to unlock Art-Net and sACN Output. The ETCnomad Maximum key also unlocks OSC and Midi input for Encoders and Faders.

Please note that ETCnomad keys do not unlock additional Art-Net or sACN output on Hog consoles.

To use an ETCnomad Key with Hog 4 PC v3.12.0 or greater follow these steps:

1. Connect the ETCnomad Key to a computer with Hog 4 PC v3.12.0 or greater installed.

Only one ETCnomad Key can be plugged into the computer at one time. Stacking keys is not supported.

2. Start Hog 4 PC and launch a new or existing show.
3. Open the Network window (Setup → Network)
4. Click on the DMX Processor running locally on the Hog 4 PC computer. (this is most likely DMX Processor #1)
5. Press the Settings button at the top of the network window to open the DMX Processor Settings window.
6. Select the “DMX Widgets” tab in the DMX Processor Settings window.
7. Press the blue plus button on a DMX universe to add a Nomad License Key mapping.
8. Use the drop down menu to select an ETCnomad Key output. If the key is unplugged/replugged during a show then any of its outputs that were not previously mapped will not appear in the dmx widgets mapping menu again until you log off and relaunch the show.
9. Click OK or APPLY to confirm the mapping. Art-Net and sACN output is now enabled for universes mapped to ETCnomad key outputs. For details on how to further configure Art-Net and sACN output please read *Art-Net and E1.31(sACN)* (p.78).

Section 4: Shows

4.1 Launch a New Show

To launch a new show:

1. Press the Launch New Show button in the start window.
2. Use the browser window to select the directory where you wish to store the show, give it a name, and then press the finish button.
3. Congratulations! You are now running a new show file.



TIP

If the launch new show button is greyed out or unavailable make sure that the "run server" option is checked in the start screen's settings window. If "run server" is checked but the new show button is still greyed out then it's possible another console is running a show on the same port on the network.

4.2 Launch an Existing Show

To launch an existing show press the Launch Existing Show button in the start window to launch the last launched show file. Alternatively you can press the Browse button to select from existing shows on your console's hard drive, a USB flash drive, or a CD. Show files with a



icon are "ready to launch" existing show files. Show files that have a



icon are archived show files and will need to be extracted to the hard drive in order to load. The un-archiving process is done automatically by the console but will slightly lengthen the amount of time needed to launch the show.

4.3 Connect to a Network Show

To connect to a show already running on the network look at the "connect to show" section of the start window. If a show is running on the network and on the same port

number then its file name will show up on the button. Pressing the button will connect the console to that show.

If "No Show found" is displayed on the button then it's possible your network settings may need to be reconfigured in order to connect to a network show. First check the following :

- Make sure your console is set to the same port number as the server console on the network.
- Check that your console's IP address settings are correct for that particular network setup.

4.4 Change the Currently Loaded Show

If you are logged into a show but want to change to a different show:

1. Setup → Quit
2. Select Log Off.
3. In the Start window, either launch a new show or browse to launch an existing show.

4.5 Automatically Launch a Show at Console Startup

You can assign the Hog 4 OS to automatically launch an existing show file at startup:

1. Setup → Control Panel → Auto Launch :
2. Select Enable Auto Launch.
3. Choose a show file you wish to auto-launch.
4. Assign a delay time which will determine how long the console will wait before the show is automatically launched.

At startup, a pop-up window will tell you that the show will be launched automatically after the assigned delay; see *Figure 4.1, "The Auto Launch window"*. Click Load Now to ignore the remaining delay and launch the show immediately. Click Cancel to return to the Start window. If you specified a delay of 0 seconds, the delay window will not be displayed.

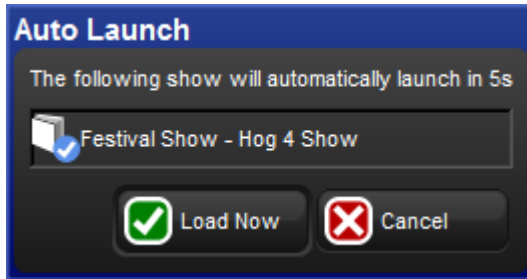

Figure 4.1. The Auto Launch window

4.6 Managing Show Data

All show data is stored on the internal hard disk of the console. Show files and folders are stored in the Shows folder while libraries are stored in the Libraries folder.

As you edit your show file all of your changes are immediately saved to the console's internal hard disk. In the event of power failure the Hog 4 OS will have already saved the show data to disk so that none of your work is lost.

You can use the Show Manager window (see *Figure 4.2, "The Show Manager Window"*) to backup your current show file, check the integrity of your current show file's data, or to move, copy, and delete existing shows files. Please note that the currently loaded show file cannot be deleted or renamed.

To open the Show Manager:

- Setup → Shows

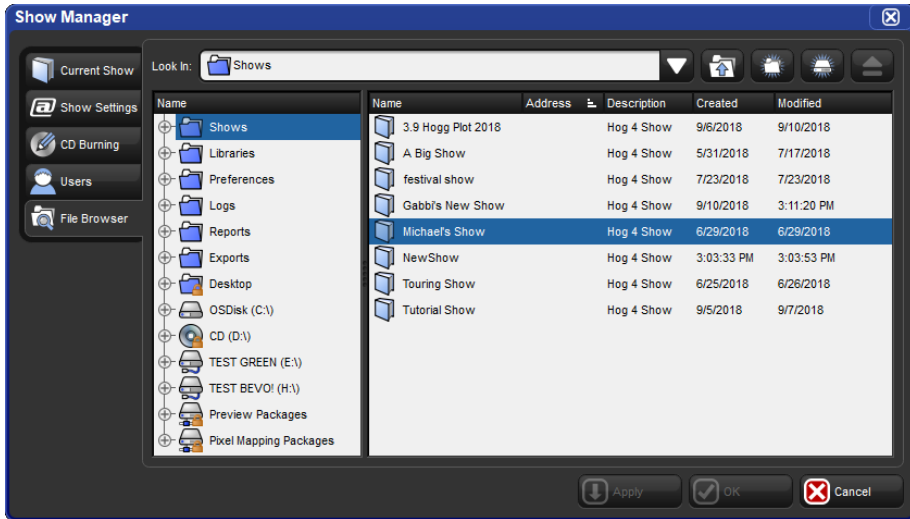

Figure 4.2. The Show Manager Window

4.6.1 Recovering Show Files from a console that won't boot

In the rare even that the console will not boot into the Hog 4 OS, the show files stored on the console's hard drive can be recovered and copied to an external USB flash drive using the following procedure:

1. Turn off console power.
2. Connect USB keyboard to the console (use built-in keyboard on Hog 4 Console)
3. Ensure that all other USB devices are disconnected from the console.
4. Turn on console power.
5. Hold down the escape key on the external keyboard while booting.
6. Follow the instructions on the screen.

4.7 Startup Comment Macros

You can assign comment macros to be executed when a show file is launched. Comment macros can be used to automate a variety of tasks such as recalling views or changing pages. Startup comment macros are assigned in the Misc pane of the User Preferences window:

- Setup → Preferences → Misc

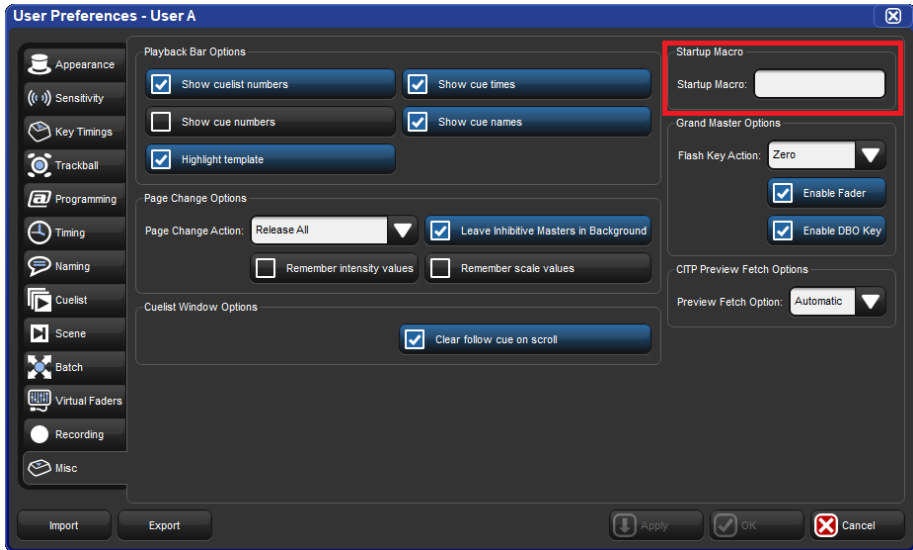

For details of the macro syntax, see *Macros* (p.399).



Tip

Startup macros only execute when the show file is initially launched. Any consoles joining a network show will not execute the startup macro.

4.8 Backing Up Your Show

It is recommended that you backup your show file regularly by saving a compressed copy of your show file on the console's hard disk or on a USB Flash Drive. Backup files are small in size and are also easy to transfer from one console to another. Compressed backups provide a method for reverting to older archives of your show file should a major problem occur with your show file.

Use the following steps to make a compressed show file backup:

1. Setup → Shows → Current Show
2. Click Backup.
3. Browse to a location on the hard drive or an external disk to save the backup file.
4. Click OK. A compressed copy of your show will be saved with '_bck' appended to its file name.

**Tip**

You should backup your show files to external media regularly so that if something catastrophic happens to you console or internal hard drive you can still access the backups.

The Hog 4, and Full Boar 4 consoles also feature a quick backup button on the bottom right hand side of the right screen's main toolbar. Clicking on the "backup" button will quickly generate a backup of your show file in the shows directory using your show file's name. If other backups with the same name exist in the shows directory the console will automatically append the new backup file with a number.

4.9 Optimizing Show Files

When working with show files originally created with older versions of the Hog 4 OS or Hog 3 OS it is sometimes beneficial to optimize the show file's data to take advantage of the latest methods used by the Hog 4 OS to compress and store show data. Running the compress show utility can sometimes help to significantly reduce the size of a show file, improve log on/off times, speed up show backups, and/or improve network reliability.

1. Setup → Shows → Current Show
2. Click compress show.
3. The console will now scan the look data in the show (cues, palettes, scenes, etc.) and re-write the data in the show file using the most current and optimized methods utilized in the Hog 4 OS.

4.10 User Preferences

Settings within the User Preferences window are stored per user as part of the show file. If a show has more than one user the console will prompt the operator to select a user when the show is launched. (see *Users (p.114)*)

4.10.1 Desklight, Worklight, and Vent Light Preferences

You can individually adjust the brightness of the console's desklights, worklight, and front panel key LEDs by holding down the Setup key and adjusting the coordinating parameter wheel.

The vent light brightness level on the Hog 4, Full Boar 4, and Road Hog 4 consoles is controlled by a slider that is located in the Appearance pane of the User Preferences window. The vent light will turn off during periods of console inactivity as determined

by the *Changing the LCD Backlight Timeout (p.53)* setting. Similar to the desk lights, the vent light will come on at full intensity on a cold boot before you have loaded a show file.

The desklights on most of the consoles in the Hog 4 family feature both blue and white LEDs, with the exception of HedgeHog 4 which only has white led desklights. By default the desklights are white during normal activity and turn blue during periods of inactivity as determined by the *Changing the LCD Backlight Timeout (p.53)* setting. If you prefer the desklights to always be blue, you can select Use Blue Desklights in the Appearance pane of the User Preferences window.

4.10.2 Touchscreen Backlight Brightness

You can adjust the brightness of each of the console's touchscreen backlights by holding down the Setup key and adjusting the coordinating parameter wheel.

4.10.3 Trackball and Trackball Ring Preferences

The Trackball and it's outer ring have two modes:

- **Pointer Mode:** The trackball controls the on-screen pointer, like a mouse on a personal computer while the trackball ring acts as a vertical scroll wheel.
- **Position Mode:** The trackball lights up in blue and controls the position (pan and tilt) of fixtures while the trackball ring controls whichever function is assigned to it in the Trackball tab of the User Preferences window.

You can switch between the two modes by pressing the top right Trackball key.

To lock the Trackball to one mode:

1. Setup → Preferences → Trackball
2. Select Pointer or Position from the drop down menu to lock the Trackball in that mode. Select Toggles to restore the ability to change modes with the top right Trackball key.
3. Select OK to apply and close.



Tip

Make sure you have an external mouse connected if you lock the Trackball in position mode, and you don't want to control the on screen pointer only by pressing the touchscreens.

Trackball Keys

You can configure the function of the four keys surrounding the Trackball according to the current mode (pointer or position). For example, in pointer mode you can have Right

Click, Left Click, Flip and Ball Mode mapped while in position mode you could have Flip, Next, Ortho Toggle and Ball Mode mapped. The Trackball keys are assigned in the Track Ball pane of the User Preferences window; see Figure 4.3, “The Track Ball pane of the User Preferences window”.



Figure 4.3. The Track Ball pane of the User Preferences window

The following navigation functions are available:

- **Ball Mode:** switches the Trackball between position and pointer modes.
- **Ortho Toggle:** switches the Trackball between Ortho and Normal. When in position mode, with ortho on, the Trackball will only control pan or tilt, not both at the same time. This can be useful for accurately setting fixtures.
- **Right Click:** the same as a right-click with the mouse. This is usually used to bring up a contextual menu with commands such as copy and paste.
- **Left Click:** the same as left-click with the mouse.
- **Open:** mimics the open button on the front panel
- **Set:** the same as the Set key, but closer to the Trackball for quick cell editing. (not compatible with trackball POS mode)
- **Close Window:** closes the active window.

- **Toggle Kind Keys/Cmd keys:** toggles the function keys between kind mode and command key mode.

In addition, the following fixture and playback functions are available:

- **Next:** sub-selects the next fixture in the current selection. See *Sub Selections (p.153)*.
- **Back:** sub-selects the previous fixture in the current selection. See *Sub Selections (p.153)*.
- **Select All:** selects all the fixtures currently in the Programmer. See *Select All (p.153)*.
- **Flip:** changes the pan and tilt of a moving head fixture to point at the same position on the stage, but from the other end of its movement range. See *Flip (p.159)*.
- **Fade Changes:** toggles the state of the Fade Changes button in the active editor. See *Fade Changes (p.285)*.
- **Next Page:** advances to the next page in the page directory. See *Changing Page (p.336)*.
- **Out:** assigns the current selection's intensity to zero; see *Intensity (p.157)*.

The default settings for the Trackball keys are:

Trackball Key	Pointer Mode	Position Mode
top left	Funcs Key Mode	Func Keys Mode
top right	ball mode	ball mode
bottom left	left click	next
bottom right	right click	flip

4.10.4 Center Wheel Preferences

The user preference for which fixture functions are assigned to the center wheel on the front panel of the Hog 4 is managed in the Center Wheel pane of the User Preferences window. In this window you can assign as many functions as you like to the center wheel by dragging functions from left hand side of the window to the wheel display on the right hand side of the window. To delete functions from the center wheel click on the function in the right hand pane of the preferences window to highlight the function in blue and then press the delete key on the console front panel.

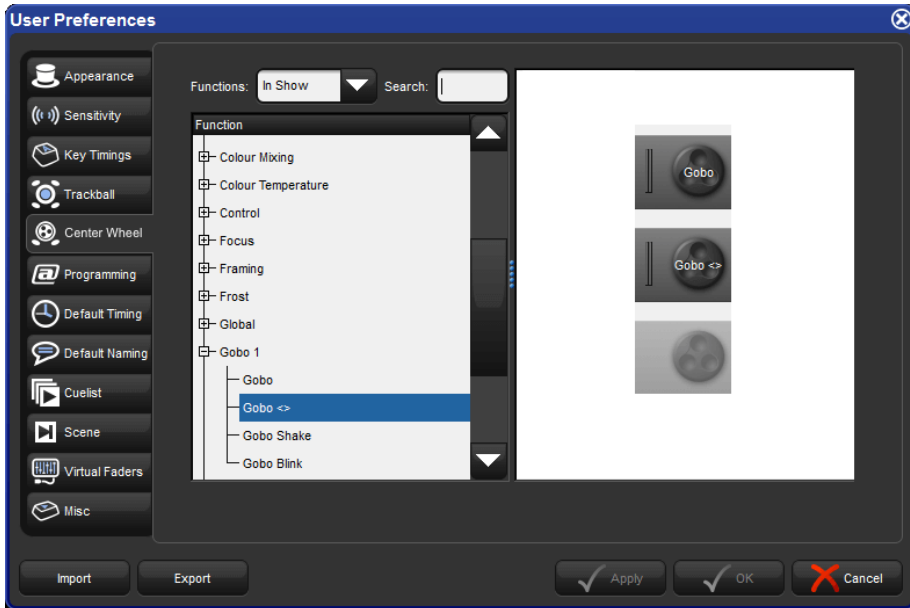

When a fixture selection is made functions assigned to the center wheel will be displayed on the toolbar located at the bottom of the front panel's center display. Functions that you've assigned to the center wheel will only be displayed if they are valid for your current fixture selection.

To cycle the center wheel through the functions press the button to the bottom right of the center wheel. The action of the button to the bottom left of the center wheel is determined by the Encoder Wheel Options preference (see *Encoder Wheel Button Options (p.101)*). The inner part of the center wheel acts exactly like the main encoder wheels on the desk. The outer spring loaded ring of the center wheel acts more like a shuttle whereby a move in either direction will initialize a value change at a fixed rate. The more you turn the ring the high the rate of change.



Encoder Wheel Button Change Function

4.10.5 Encoder Wheel Button Options

You can adjust the action that occurs when pressing the grey encoder wheel button (located to bottom left of each encoder wheel) in the Programming pane of the User Preferences window:

Setting	Function
Fine Mode (default)	makes encoder wheel adjustments more refined (same as holding pig key) when encoder wheel button is held down
Cycle Feature Mode	changes the feature mode of the function assigned to the encoder wheel when the encoder wheel button is pressed
Set	opens a direct entry dialogue box for the encoder wheel when button is pressed (similar to holding set and turning encoder wheel)
Max/Min	sets wheel to max value when button is pressed first time; sets wheel to minimum value when pressed second time
Neg/Pos	sets wheel to negative value when button is pressed first time; sets wheel back to positive value when pressed second time
Adjust by One	increments wheel by one real world value when button is pressed (decreases wheel value by one when holding pig and pressing button)

4.10.6 Keys and Button Preferences

You can adjust various key timings in the Key Timings pane of the User Preferences window:

Setting	Function
Key repeat delay	When you hold down a key, this is the delay before it starts to repeat.
Key repeat period	When you hold down a key, this is the time between repeats.
Key double press time	When you press a key twice within this time, the console interprets this as a double-press.

Note: these timings only apply to the physical keys on the console's front panel, and not to the on-screen buttons.



Tip

Double-pressing a key is often a shortcut way of opening the window associated with the key; for example, double pressing the Beam key will open the Beam directory window. If you prefer not to use the double-press shortcuts, then assign the double-press time to zero to disable it.

4.10.7 Importing and Exporting Show Preferences

You can export the user preference settings as a separate file so that you can later import them into any show that you are working on. To export your user preferences:

1. Setup → Preferences : open the User Preferences window.

2. Click on the Export button, and select a location to save the preferences file to.

To load your preferences into the current show:

1. Setup → Preferences : open the User Preferences window.
2. Click on the Import button, browse to the location of your preferences files, and select a preferences file to import.

4.11 Merging Shows

Show merging allows you to take the programming from one show and merge it into another show. To merge show files you must first load the show you want to merge data into. This is known as the *current* show. The show you then select to merge data in from is called the *source* show.

To select a *source* show to merge in:

1. Setup → Shows → Current Show : opens the Current Show pane of the Show Manager.
2. Press Merge to be guided through the merge process. The Merge Show window will open; see *Figure 4.4, "The Source Location page of the Merge Show window"*.
3. Choose a source show file. Note that if you have chosen a backup (.bck or .shw) file, it may take a few extra moments for the console to uncompress the show file and read its contents.
4. Once you have chosen a source show, you will be offered several options for data that can be merged: Fixture Types, Fixtures, and Programming (user kinds, groups, palettes, plots, cuelists, scenes, pages, macros, views, and reports).

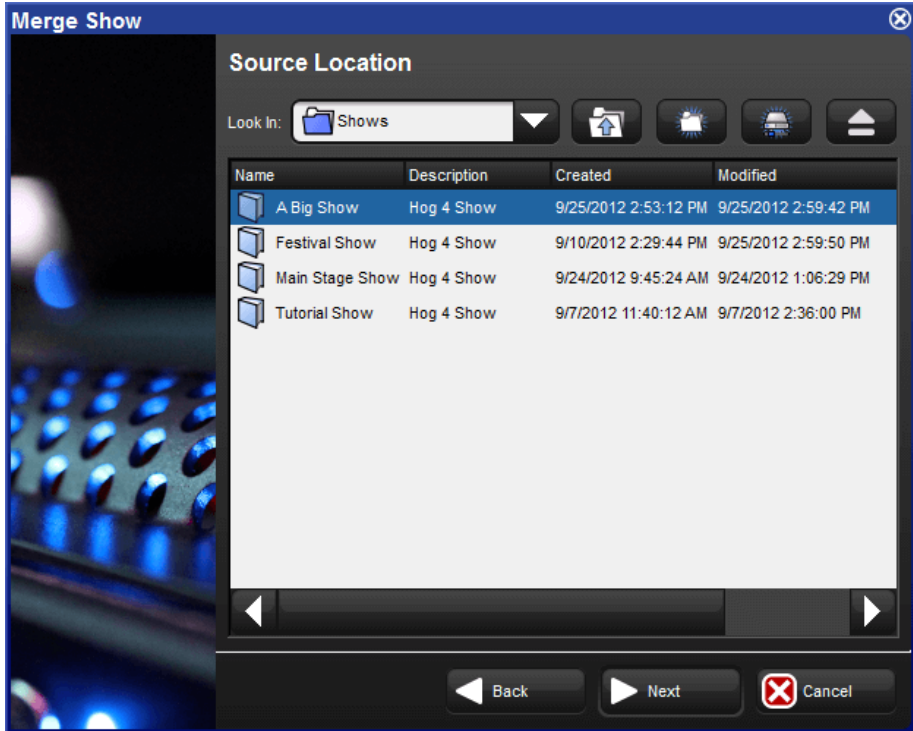

Figure 4.4. The Source Location page of the Merge Show window

4.11.1 Merging Fixture Types

Once you have selected a source show, Hog 4 OS compares the fixture types contained within each show file and creates a list of fixture types which have changed; see *Figure 4.5, "The Type Merge page of the Merge Show window"*.

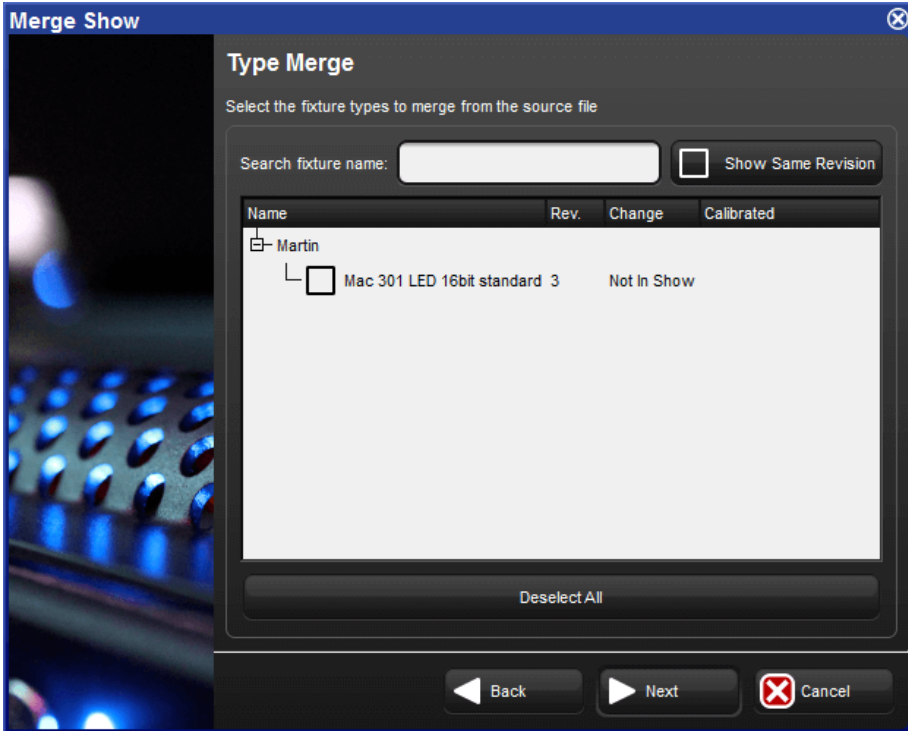

Figure 4.5. The Type Merge page of the Merge Show window

An expanding tree shows the fixture types that do not match exactly and will explain what their differences are:

- **Newer:** the fixture type in the source show is a newer revision.
- **Older:** the type in the source show is an older revision.
- **Not In Show:** the type is in the source show but not the current show.

If you want to see all fixture types in the source show file even if they match the fixture types destination show, press Show Same Revision.

Select the fixture types to merge by clicking on their check boxes. The Deselect All button allows you to clear the current selection and start again. Press Next to continue.

4.11.2 Merging Fixtures

After choosing to merge fixture types, you can merge the fixtures used in the two shows; see Figure 4.6, “The Fixture Merge page of the Merge Show window”. If you choose not to merge fixtures, you will not be able to merge any programming other than macros, views, and reports.

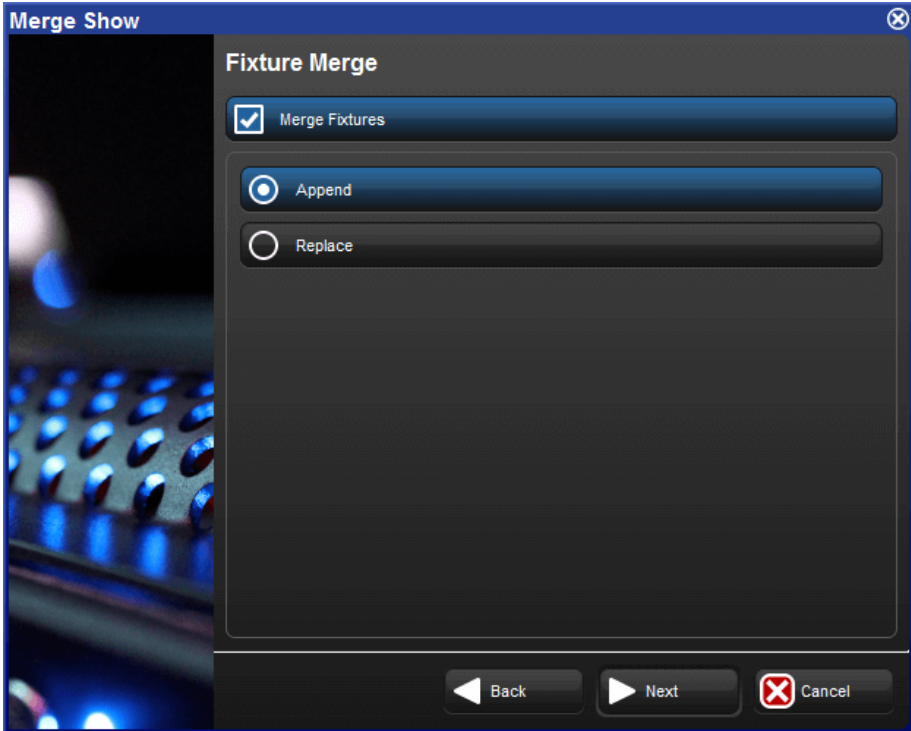

Figure 4.6. The Fixture Merge page of the Merge Show window

There are two options for merging fixtures:

Append: appending fixtures will add a copy of all of the fixtures from the source show into the current show. Any programming that is merged from the source show will use the appended fixtures and all programming in the current show will continue to use the same fixtures as before.

Replace: replacing fixtures will match fixtures from the source show with fixtures in the current show using a combination of the fixture type and user number. If a match is made, the fixture in the current show is replaced with the one in the source show and all programming in the source and current show that used that fixture will use the merged fixture. If no match is made, the source fixture is appended to the current show as above.



Important

If you merge fixtures and then merge programming, because both the source show and the current show are using the same fixture, any programming from the source show using that fixture will overwrite the programming in the current show.

4.11.3 Merging Programming

After merging fixtures, you can merge the programming (user kinds, groups, palettes, plots, cuelists, scenes, pages, macros, views, and reports) from the source show; see Figure 4.7, “The Group Merge page of the Merge Show window”.

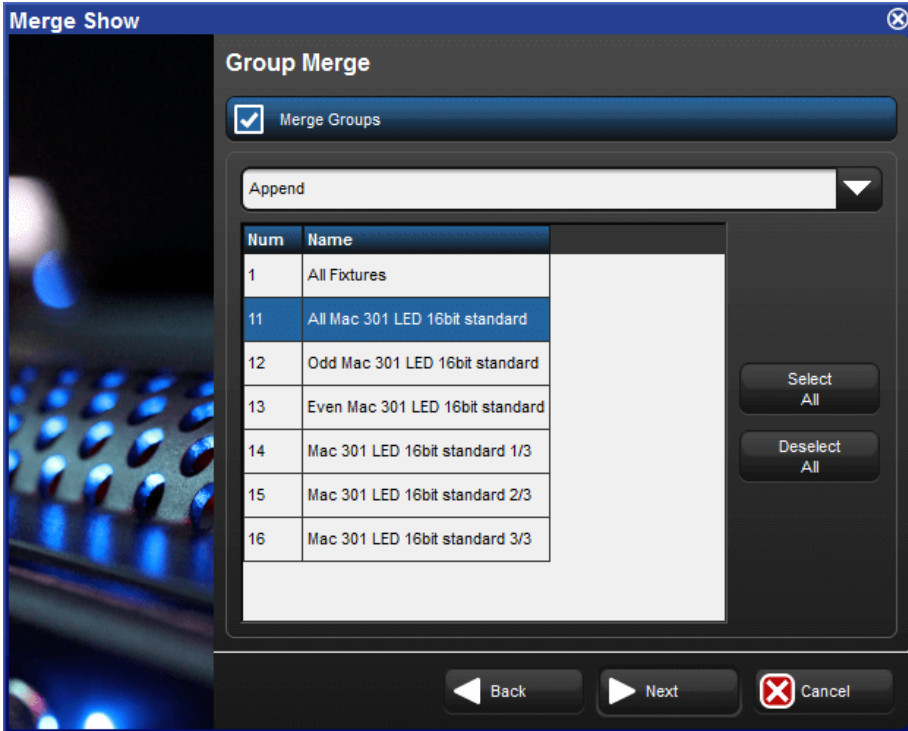

Figure 4.7. The Group Merge page of the Merge Show window

When merging programming the following merge methods are available from the drop down menu in the Merge field:

- **Append:** appends all of the programming from the source show to the current show.
- **Append Different:** appends programming from the source show if programming of the same type and name cannot be found in the current show.
- **Merge By Name:** merges source show programming into the current show when programming objects of the same type and name cannot be found in the current show; if programming objects of the same type and name already exists in the current show then the source show programming is not merged in.

- **Merge By Number:** merges source show programming into the current show when programming objects of the same type and number cannot be found in the current show; if programming objects of the same type and number already exists in the current show then the source show programming is not merged in.
- **Replace:** replaces current show programming with source show programming when programming object numbers match; appends source show programming objects that do match current show programming objects.

After selecting the merge method, you can select which programming objects to merge by clicking on each item displayed in the window. Items highlighted in blue are selected for merging.



Tip

You cannot replace palettes in the current show because you could replace a palette with one that doesn't contain programming for fixture parameters that other programming expects it to have.

4.11.4 Dependencies

In order to merge certain parts of a show, you must have chosen to merge other parts:

- To merge groups, you must have merged fixtures.
- To merge palettes, you must have merged fixtures.
- To merge cuelists and cues, you must have merged fixtures and palettes.
- To merge scenes, you must have merged fixtures and palettes.
- To merge batches, you must have merged fixtures, groups, palettes, cuelists, and scenes.
- To merge pages, you must have merged fixtures, cuelists, and scenes.
- To merge plots, you must have merged fixtures.

4.11.5 How Patching is handled when merging shows

When performing a show merge the console will automatically do the following:

- Fixtures appended to the current show file will maintain their patch information unless their patch information conflicts with patch information already used by fixtures in the current show file; in the case that patch conflicts exist then the appended fixtures will be added to the current show file without patch information.
- Fixtures in the source show file that are replacing fixtures in the current show file will use the patch information of the current show file.

To summarize: Hog 4 OS will always protect the patch records of the current show file and will only allow appended fixtures to bring their patch records into the current show file provided that conflicts don't exist.

4.11.6 Merging Examples

Example 1: You have programmed your show on two separate consoles (perhaps one controlling moving fixtures and one controlling conventional fixtures) and you want to merge the shows for playback on one console. Each show file contains identical palette and cuelist structures, but they just control their own fixtures.

In this case, Append fixtures and Merge By Name for all programming.

Example 2: You have two shows programmed using the same rig, which you now want to merge. Each show contains exactly the same fixtures.

In this case, Replace fixtures, and Append Different all of the programming (assuming all of the programming has unique names).

4.12 Importing/Exporting Cuelist Data

This section covers which types of cuelist data can be imported/exported and the file formats supported for each.

4.12.1 Exporting Cuelist Data to an XML File

To export all fundamental cuelist data from a show file into an XML document:

1. List → Open : opens list directory window.
2. Press the Cuelist Export button located at the top of the list directory window.
3. Select a file location for export, give the file a name, and press okay.
4. Once the export is complete a dialogue box will appear confirming export is complete. Press okay.

4.12.2 Importing Cuelist Data from an XML File

WARNING: Importing cuelist data into a show is an "all or none" process and is done on a replacement basis. All cuelist data written in the imported XML document will be included in the import and will overwrite the data in the show file with the data supplied in the XML document. However, XML data does not modify, delete, or alter fixture programming data in the show file. XML import only adds/modifies non-look data such as cuelist and cue names.

To import an XML file containing cuelist data into a show:

1. List → Open : opens list directory window.
2. Press the Cuelist Import button located at the top of the list directory window.
3. Select an XML file to import and press okay.
4. If the import process is successful a dialogue box will appear confirming import is complete. Press okay.
5. If non-conforming data or markup errors are detected the XML import WILL NOT complete and an error dialogue box will appear. Press the details button on the error to see more information about the errors detected in the XML document. Make note of the errors mentioned in the dialogue box, make the necessary adjustments to the XML document in a separate XML editor on your PC, save the file, and then re-attempt to import into Hog 4 OS.

Creating XML Files for Hog Cuelist Import

The following cuelist data is supported for XML import into Hog 4 OS show files and should be formatted as demonstrated below:

Core Data: XML identification header, show name, software version XML was created with

Sample XML :

```
<?XML version="1.0" encoding="UTF-8"?>
<Hog xmlns:xsi="http://www.w3.org/2001/XMLSchema-instance">
<Show name="TestShow" maj_version="3" min_version="4" patch_version="0"
build="1225"/>
```

Cuelists: number, name, comments, color coding

Sample XML Data :

```
<Cuelist number="1" name="Main List" comment="Main Cuelist for Show" color="174 255
0"/>
```

Cues: number, name, comments, trigger data (wait, halt, follow, timecode, clock), milliseconds, time, start time

Sample XML Data:

```
<Cue number="1" name="PreShow" comment="Red Curtain Wash" trigger="wait" milli-
seconds="1000"/>
```

4.12.3 Importing Cuelist Data from Reaper

Regions/Markers created in Reaper (a dedicated Digital Audio Workstation Application) can be exported to a separate csv file that can be imported into Hog show files. Importing

Reaper Region/Marker data does not modify, delete, or alter fixture programming data in the show file. Imported Reaper data only adds/modifies non-look data such as cuelist names, cue names, and timecode values for cues.

Exporting Reaper Regions and Markers to a csv file

1. Ensure the Reaper project timeline is set to **Hours:Minutes:Seconds:Frames** (this can be set by right clicking on the timeline area of the Reaper application)
2. Open the Marker/Region Manager Window in Reaper (ctrl+alt+shft+R)
3. Look at the top right hand corner of the Marker/Region Manager Window and ensure the "marker" and "region" options are both checked
4. Right click inside the Marker/Region Manager window and select "Export regions/markers..."
5. Select an easy to access destination such as the desktop or an external USB flash drive and click okay. A separate csv file will now be created in that location which can be imported into Hog 4 OS using the import instructions provided in this chapter.

How Hog 4 OS interprets Reaper Data

- Regions are imported as cuelists and markers are imported as cues. Therefore, markers contained within a region's timespan are interpreted as cues within a cuelist.
- If no regions are found in the csv file exported from Reaper then all markers will be imported into as a single cuelist which will be appended to the end of the list directory.
- Markers are assigned cue numbers according to their relative timecode position within a region; therefore, a marker's ID number has no correlation to the cue number it is assigned during import.
- Regions are assigned cuelist numbers according to their ID number in Reaper; therefore, a Region's ID number in Reaper and the cuelist number it is assigned during import are directly correlated.
- The import will fail if reaper project contains regions that don't have markers. Be sure to check that all the regions in the Reaper project have at least one marker within them.
- Importing Reaper data will not modify, delete, or alter fixture programming data in the show file. Importing Reaper data only adds/modifies non-look data such as cuelist and cue names and associated timecode values.

Importing a Reaper region/marker csv file into a show

1. List → Open : opens list directory window.

2. Press the Cuelist Import button located at the top of the list directory window.
3. Select the Region/Marker csv file previously exported from Reaper and press okay.
4. If the import is successful a dialogue box will appear confirming the import is complete. Press okay.
5. If non-conforming data or errors are detected the import WILL NOT complete and an error dialogue box will appear. Press the details button on the error to see more information about the errors detected in the csv file. Make note of the errors mentioned in the dialogue box, make the necessary adjustments in Reaper, re-export the region/marker csv file from Reaper, and then re-attempt to import into Hog 4 OS.

4.12.4 Importing Cuelist Data from Inqscribe

Transcript data created using Inqscribe (a dedicated transcript notation application) can be exported to a separate XML file which can be imported into Hog show files. Importing Inqscribe data does not modify, delete, or alter any existing cuelists data or fixture programming data in the show file. Importing Inqscribe data only results in a single new cuelist being appended to the show that contains the data transcribed in the Inqscribe project.

Exporting Inqscribe transcripts to an XML file

1. Open the Inqscribe transcript settings window. Make sure the "inserted timecode format" is set to one of the bracketed formats (if the timecode entries in the transcript are not bracketed the import will not succeed).
2. Create a transcript in Inqscribe. Refer to *How Hog 4 OS interprets Inqscribe Data (p.111)* for help with creating a transcript that is compatible for Hog cuelist import.
3. Click on File, Export, and select XML.
4. Select an easy to access target destination such as the desktop or an external USB flash drive and click export. A separate XML file will now be created in that location which can be imported into Hog 4 OS using the import instructions provided in this chapter.

How Hog 4 OS interprets Inqscribe Data

- Each Inqscribe XML document is imported as a single cuelist which is appended to the end of the list directory as a new cuelist.
- It is not possible to alter existing cuelist data using the cuelist import feature with Inqscribe exported XML files.
- A bracketed timecode entry in the Inqscribe transcript is interpreted as a single cue entry with a time-code wait column value.

- Plain text following a timecode entry is interpreted as the cue name for the cue that is generated for that timecode entry.
- **WARNING:** A plain text entry **MUST** follow each and every timecode entry in your transcript, otherwise the XML export from Inscribe will not conform to the Hog import standard and cue data be missing/incorrect.

Here is an example of an Inscribe Transcript that is compatible with Hog cuelist import:

```
[00:00:10.12] Opening
[00:00:16.08] Add US Truss
[00:00:22.01] Color Change
[00:00:37.14] Tilt DS Fixtures
[00:00:53.23] Add Blue Pars
[00:01:18.03] Fan out to audience
[00:01:29.04] DSC Spot Solo
[00:01:39.19] Fade Out
```

Importing an Inqscribe XML file into a show

1. List → Open : opens list directory window.
2. Press the Cuelist Import button located at the top of the list directory window.
3. Select the XML file previously exported from Inqscribe and press okay.
4. If the import is successful a dialogue box will appear confirming the import is complete. Press okay.
5. If non-conforming data or errors are detected the import **WILL NOT** complete and an error dialogue box will appear. Press the details button on the error to see more information about the errors detected in the XML file. Make note of the errors mentioned in the dialogue box, make the necessary adjustments in Inqscribe, re-export the XML file from Inqscribe, and then re-attempt to import into Hog 4 OS.

4.13 Importing/Exporting Fixture and Patch Data

This section covers which types of fixture data and patch data can be imported/exported and the file formats supported for each.

4.13.1 Exporting Fixture and Patch Data to an XML File

To export all fundamental fixture and patch data from a show file into an XML document:

1. Fixture → Open : opens the fixture window.
2. Press the Export Patch button located at the top of the fixture window.
3. Select a file location for export, give the file a name, and press okay.
4. Once the export is complete a dialogue box will appear confirming export is complete. Press okay.

4.13.2 Importing Fixture and Patch Data from an XML File

Importing fixture and patch data into a show file adds new fixtures to the show specified in the XML document that do not already exist in the show file and also overwrites any existing data for fixtures that match the fixture type and user number data specified in the XML document. Imported data includes DMX patch records, IP address patch records, pan/tilt invert settings, patch notes, and so forth. Second, the import will schedule any fixtures specified in XML document that are not already in the show (along with any supplemental patch data or fixture information for those fixtures). Importing fixture and patch data will NEVER modify, delete, or alter any fixture programming in the show file. Importing Fixture and Patch data only adds and/or modifies the scheduled fixtures and their patch information.

To import an XML file containing fixture and patch data into a show:

1. Fixture → Open : opens fixture window.
2. Press the Import Patch button located at the top of the fixture window.
3. Select an XML file to import and press okay.
4. If the import process is successful a dialogue box will appear confirming import is complete. Press okay.
5. If non-conforming data or errors are detected the XML import WILL NOT complete and an error dialogue box will appear. Press the details button on the error to see more information about the issues detected in the XML document. Make note of the errors mentioned in the dialogue box, make the necessary adjustments to the XML document in a separate XML editor on your PC, save the file, and then re-attempt to import.



Tip

The console creates any missing DPs in the show to accommodate the patch points used in the imported XML fixture import file. XML fixture import does not require physical DPs to be attached or running. When importing fixtures via XML, Hog 4 OS schedules fixtures using the library currently selected in the fixture schedule window. If the selected fixture library is a special library such as one downloaded from

the FTP site or if the selected library is "invalid", then the fixture XML import will fail because the fixtures cannot be found.

4.14 Users

Users are managed in the users tab of the show manager window. Each user in a show file has its own customizable set of preferences (see *User Preferences (p.96)*) and is able to send messages in the chat window from their designated user name. A single user called "User A" will be created for all new and pre-existing show files when loaded in Hog 4 OS v3.6.0. When more than one user exists in a show file the console will prompt the operator to select a user when logging into the show file.

4.14.1 Managing Users

To add a new user to a show:

1. Setup → Shows : opens the show manager window.
2. Select the Users tab.
3. Type a name in the "create" field and press enter.

To remove an existing user from a show:

1. Setup → Shows : opens the show manager window.
2. Select the Users tab.
3. Select any user in the window so that it is highlighted in blue.
4. Press the remove button and confirm.

Note: Local and Remotely logged on users cannot be removed. Only user accounts that are not logged onto the show can be removed.

To switch to another user in a show:

1. Setup → Shows : opens the show manager window.
2. Select the Users tab.
3. Select the user you wish to switch to so that it is highlighted in blue.
4. Press the switch button and confirm.

To clone an existing user in a show:

1. Setup → Shows : opens the show manager window.
2. Select the Users tab.

3. Select a user in the window so that it is highlighted in blue.
4. Press the clone button.

To rename an existing user in a show:

1. Setup → Shows : opens the show manager window.
2. Select the Users tab.
3. Select a user in the window so that it is highlighted in blue.
4. Press the set key.
5. Type in a new name and then press enter to confirm.

4.14.2 Chat

To start a global show-wide chat with other users logged onto the same show via the HogNet network:

1. Click on the chat icon on the main toolbar. The chat icon is a white speech bubble with blue text.
2. Type in the message field of the chat window and press enter to send.
3. Chat messages are tagged with the user name of the sender and are viewable by all consoles and all users logged onto the show.

If the chat window is closed when a new messages is posted by another user on the network the chat icon will turn green to indicate there are unread messages. Chats are also broadcast from the console via OSC and can be received using the path *hog/status/chatline/*



Tip

Chat is not only useful for communicating between networked consoles but also a great tool for typing messages to other operators on a single console system which may be shared by multiple operators for given show.

Section 5: Adding, Patching, and Managing Fixtures

5.1 Adding Fixtures

To add a fixture to a show:

1. Open + Fixture : opens the Fixture window.
2. Press the Add Fixtures button in the top left hand corner of the Fixture window. The Fixture Schedule window will open with a list of fixture personalities in the current show file as well as fixtures that are part of the currently chosen Fixture Library.
 - The currently chosen fixture library is listed at the bottom of the fixture selection window. To add fixtures from another library you must first install the library onto your console. See *Download and Install Fixture Libraries (p.419)* for details.
 - Each fixture is listed under its manufacturer, while conventional fixtures such as Desk Channels and Scroller-Dimmers are listed under Generic.
 - The DMX Footprint column displays each fixture's total dmx channel count. This can often be helpful when determining which fixture you should schedule when several modes or options exist.
 - To filter the names of the fixtures to more quickly find the exact fixture type you are looking for type a fixture name into the Search fixture name field at the top of the window.
 - To filter the list of fixtures to only the fixtures currently scheduled in the show by click on the Limit to fixture in use button at the top of the Fixture window.
 - To view the individual parts of compound fixtures click on the Show Compound Parts button. This is recommended for advanced users only.

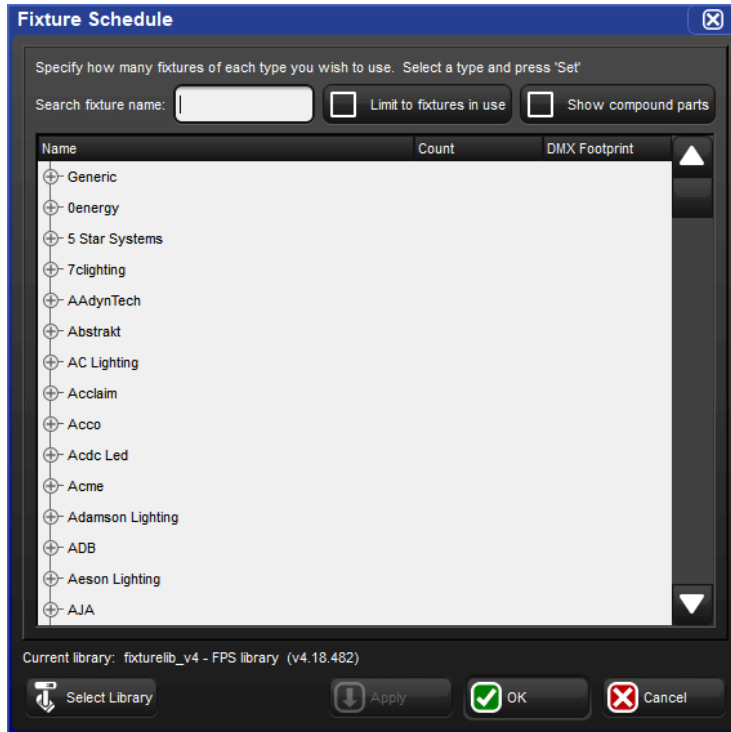

Figure 5.1. The Fixture Schedule window

3. Click on the fixture type that you want to add and use the count column to input the number fixtures of that type your wish to add to the show.
4. Press the OK button. The fixtures have now been added to the fixture window where they can be assigned user numbers and patched to dmx outputs. To add more fixtures to the show repeat this procedure from step 1.

5.2 Assigning User Numbers to Fixtures

The User Number is the number used to select a particular fixture when programming. By default, Hog 4 OS gives each fixture type its own range of user numbers. However, if you manually re-assign more than one fixture to the same user number, the console will display an asterisk next to the fixture's user number in the Fixture window to indicate that user number is not unique in the show file:

Num	Note	DP	Patch
1 *		1: DP 8000	1: 401
2 *		1: DP 8000	1: 402
3 *		1: DP 8000	1: 403
4 *		1: DP 8000	1: 404
5 *		1: DP 8000	1: 405
6 *		1: DP 8000	1: 406
7 *		1: DP 8000	1: 407
8 *		1: DP 8000	1: 408
9 *		1: DP 8000	1: 409
10 *		1: DP 8000	1: 410

To change the User Number:

1. Open + Fixture
2. Select the fixture's Num cell (short for User Number).
3. Set, [**new number**], Enter

To change several User Numbers at once:

1. Open + Fixture
2. Select a range of User Number cells by pressing or clicking, and then dragging.
3. Set, [**new number**], Enter : allocates a range of User Numbers starting with the number that you enter and increments the remaining user numbers by one.



Tip

You can renumber the fixtures in your show so that each one has a unique number irrespective of its type. By doing this you never have to specify the type when selecting fixtures, which can speed up programming. See *Selecting Fixtures* (p.147).

5.3 Assigning Dotted User Numbers to Fixtures

Dotted user numbers are composed of a whole number and a part number. For example, you may assign a fixture a dotted user number of 1.3 whereby 1 is the whole number portion of the fixture and 3 is the part number portion of the fixture. Utilizing dotted user numbers can help to reduce the amount of whole numbers used in a show, gives

the user the ability to aggregate fixtures, and take advantage of the advanced fixture selection mechanisms explained in *Selecting Fixtures (p.147)*.

Fixture Window					
Fixture Schedule	Patch @	Patch Media	Unpatch	Apply Patch	Re
Num	Note	DP	Patch		
Desk Channel					
1		1: DP 8000	1: 401		
1.1		1: DP 8000	1: 402		
1.2		1: DP 8000	1: 403		
1.3		1: DP 8000	1: 404		
1.4		1: DP 8000	1: 405		
2		1: DP 8000	1: 406		
2.1		1: DP 8000	1: 407		
2.2		1: DP 8000	1: 408		
2.3		1: DP 8000	1: 409		
2.4		1: DP 8000	1: 410		

To change a fixture's user number to a dotted user number:

1. Open + Fixture
2. Select the fixture's Num cell (short for User Number).
3. Set, [**new number**] . [**new number**], Enter

To change the user numbers of several fixtures to dotted user numbers at once:

1. Open + Fixture
2. Select a range of User Number cells by clicking/pressing and dragging.
3. Set, [**whole number**] / [**parts per whole number**], Enter. This syntax will allocate a range of User Numbers to the selected cells starting with the specified whole number and will increment the value of each of the selected cells by one part number until the specified number of parts per whole number is reached at which point the whole number value will increase by one.

Example A: [1] / [3] will assign the selected user num cells values of [1] , [1.1] , [1.2] , [1.3] , [2] , [2.1] , and so on.

Example B: [1.1] / [3] will assign the selected user num cells values of [1.1] , [1.2] , [1.3] , [2.1] , [2.2] , [2.3] , [3.1] , and so on.

Example C: [1.1] / [1] will assign the selected user num cells values of [1.1] , [2.1] , [3.1] , and so on.

5.4 Compound Fixtures

Compound fixtures are single fixture entities comprised of one or more selectable fixture parts. Compound fixtures are added to a show using the fixture schedule window the same way as ordinary fixtures. Once a compound fixture is scheduled all of its parts can be viewed in the fixture window by enabling the show details button at the top of the fixture window. The part numbers assigned to the individual parts of a compound fixture can be modified in the fixture window when show details is enabled by clicking on the part number cell and pressing the set key. Please note that every part number within a single compound fixture must be unique and that dot (period) is a legitimate part number on its own.

Example of a compound SHAPESHIFTER fixture shown in the fixture window when the show details button is enabled:

Part	Note	DP	Patch	Patch Type	Patch Note	P Address	Offset	Preview Package	Icon	Size	Color	Swp	Axes	Part Invert	TR Invert	Intensity %	Col Cal	Parked
1	master								Moving Circle	Medium		No	No	No		100%	No	No
2	static m								Circle	Small		No	No	No		100%	No	No
3	moving j								Circle	Small		No	No	No		100%	No	No
4	moving j								Circle	Small		No	No	No		100%	No	No
5	moving j								Circle	Small		No	No	No		100%	No	No
6	moving j								Circle	Small		No	No	No		100%	No	No
7	moving j								Circle	Small		No	No	No		100%	No	No

All parts of a compound fixture can be selected by entering the whole number assigned to the compound fixture on the command line and pressing enter. Individual parts of a compound fixture can be selected by entering the whole number and part number of the fixture part on the command line and pressing enter. See *Selecting Fixtures (p.147)* for more details on selecting compound fixtures and aggregated fixtures with dotted user numbers.

5.4.1 Compound Fixture Explode

The parts of a compound fixture can be broken up into individual stand-alone fixtures by opening the fixture window, selecting the compound fixture, and pressing the Compound Explode at the top of the fixture window. The new individual fixtures that result from the compound explode retain their programming but now function as regular stand-alone fixtures that can be patched, programmed, and change typed on an individual basis.

5.5 Fixture Aggregation

Sometimes a cluster of fixtures, although separate and independent from one another, frequently need to be selected and programmed together while still maintaining the ability to be selected, programmed, and patched individually. Hog 4 OS solves this problem with a feature called fixture aggregation. To *aggregate fixtures*, simply assign

dotted user numbers to the fixtures you wish to cluster together, ensuring that they share a common whole number and unique part numbers. For details on how to assign dotted user numbers to fixtures refer to *Assigning Dotted User Numbers to Fixtures* (p.119).

To select all fixtures in an aggregation: enter the common whole number shared among the fixtures on the command line and press enter.

To select an individual fixture in an aggregation: enter the whole number and part number of the fixture on the command line and press enter.

The fixture selection mechanisms described in *Selecting Fixtures* (p.147) can also be used to further sub-select, range select, or laterally select specific fixtures in the aggregated fixture cluster.

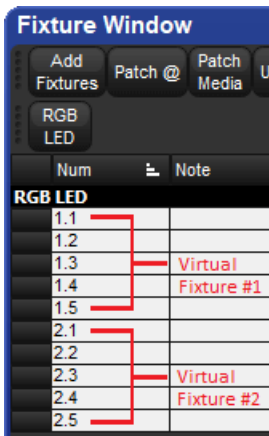

Important

Compound fixtures cannot be aggregated.

5.6 Patching Fixtures

Once fixtures have been added to a show they must be patched so that the console knows where to send control data for the fixtures (the address) and what type of data to send to the fixtures (the protocol). Many fixtures, such as moving lights, are assigned a dmx address and utilize the DMX512 protocol for remote control of their various parameters whereas other devices such as video switchers are assigned an IP address and utilize IP protocols for remote control of their device parameters. The following sub-chapters provide instructions on how to patch fixtures using these protocols.



Important

ArtNet and e1.31 (sACN) are supported by Hog 4 OS but are treated as extensions of the DMX patch data. Therefore ArtNet and sACN outputs are configured per universe via the node settings window for the DP8000. See *Art-Net and E1.31(sACN)* (p.78) for details.

5.6.1 Patching DMX Protocol Fixtures

The vast majority of moving lights and dimmers receive their control data using a control protocol called DMX-512. Under this protocol, fixtures are controlled via dmx channels and are assigned a *dmx address* (also known as the 'start address'). The number of dmx channels occupied by a fixture beyond its start address varies by fixture and by mode so it is important to ensure the fixture type scheduled in the show matches the fixture that is hung the lighting rig.



Important

When the "show details" button is enabled in the fixture window the dmx patch points for a compound fixture's individual parts are displayed, however these internal patch points are fixed and cannot be modified. To identify the true patch point of a compound fixture turn off the "show details" button.

To patch a fixture using the DMX protocol:

1. Setup → Patch : this opens the Fixture window.
2. Select the fixture fixtures you wish to patch and then press the Patch @ button to open the Fixture Patch window.
3. Select a DP8000 in the list on the left-hand side of the window. If there are no DP8000s shown, or you want to patch to one that isn't listed shown in the list, you need to add it. See *Adding and Removing DMX Processors* (p.127).
4. Click or press one of the available DMX universes shown to select a universe to patch to. The display gives a graphical indication of which addresses are already occupied. Type in a number for the fixture's DMX start address; the next free address is shown below each universe.
5. Click on OK or press Enter.
6. If you have finished patching, click on Apply Patch or close the Fixture window to send the new patch information to the DMX Processors.

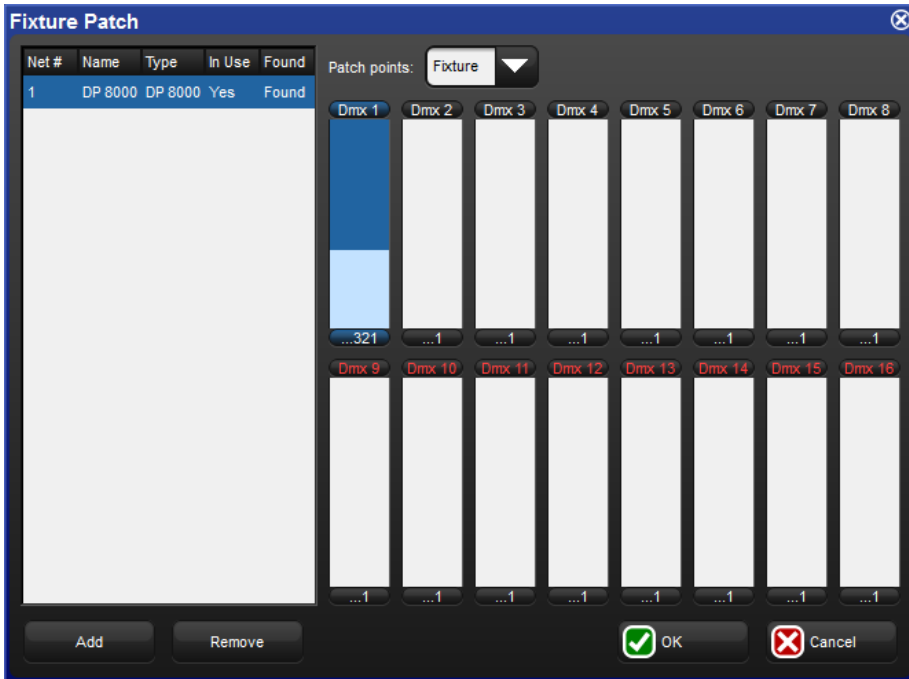

Figure 5.2. The Fixture Patch window

You can also use the keypad to patch fixtures. For example, to patch Studio Color 1 to DMX Processor 2, Universe 4, at address 17:

- Fixture 1 @ 2/4/17 Enter

To patch further fixtures to the same DMX Processor and universe, you can use the shorthand:

- Fixture 2 @ 33 Enter

To patch a fixture at the next available address on the same DMX Processor and universe:

- Fixture 3 @ Enter

Again, if you have finished patching click on Apply Patch or close the Fixture window to send the new patch information to the DMX Processors.

Patching Several Fixtures at Once

If you select several fixtures and patch them, Hog 4 OS will allocate them to a continuous range of DMX addresses, assigning each fixture's patch address so that it follows on from the last.

For example, to patch 5 Studio Colors, starting at DMX address 1:

1. Open + Fixture : open the Fixture window
2. Fixture 1 Thru 5 Patch @ 1 ,Enter : You can use the @ key as an alternative to the Patch @ button.

Studio Colors 1 to 5 will now have the incremental patch addresses of 1:1, 1:17, 1:33, 1:49, and 1:65. Note that the fixtures selected do not have to be from a contiguous range, and they can be of different types.



Tip

When you patch a range of fixtures, Hog 4 OS takes the selection order into account, so that Fixture 1 Thru 10 @ 1 patches the fixtures starting with Fixture 1 and going up in numerical order, while Fixture 10 Thru 1 @ 1 patches the fixtures starting with Fixture 10 and going down in reverse numerical order.

Patching Fixtures to Multiple DMX Addresses

You can patch one fixture to multiple different DMX addresses; this can be useful with desk channels, where you want one desk channel to control several dimmer channels. This is sometimes known as ‘soft patching’.

To patch a fixture to a second DMX address, select the fixture again and patch it as before. Alternatively, using the command line:

- Fixture (Desk Channel) 1 @ 2/1/1 + 4/2/5, Enter : patches the desk channel to DMX Processor 2, universe 1, address 1, and to DMX Processor 4, universe 2, address 5.

Similarly, you can patch a fixture multiple times so as to fill a specified range of DMX addresses. This can be useful if you want to soft patch a desk channel to a continuous series of dimmer DMX addresses.

- Fixture (Desk Channel) 1 @ 1 Thru 10, Enter : patches the desk channel to each address between 1 and 10.



Tip

You don't have to patch fixtures before you start programming. Once the fixtures have been added they can be programmed. However, without a patch, you will not be able to output DMX.

Patching Fixtures with DMX Gaps

To specify a dmX channel gap when patching press the @ key a second time when the “fixture patch” window is open. This will put the word “Gap” on the command line. Input a numerical value after the word Gap and press enter.

Example:

[1<3 @ 1 Gap 5] will result in the following patch if the fixtures being patched are 3 channels each:

Fixture 1 occupies Dmx channels 1 < 3 (then a five channel gap: 4,5,6,7,8)

Fixture 2 occupies Dmx channels 9 < 11 (then a five channel gap: 12,13,14,15,16)

Fixture 3 occupies Dmx channels 17 < 19

Patching Fixtures with DMX Offsets

To specify an offset to be used between the start addresses of fixtures when patching press the @ key a third time when the “fixture patch” window is open. This will put the word “Offset” on the command line. Input a numerical value after the word Offset and press enter.

Example:

[1<3 @ 1 Offset 5] will result in the following patch if the fixtures being patched are 3 channels each:

Fixture 1 occupies Dmx channels 1 < 3

Fixture 2 occupies Dmx channels 6 < 8

Fixture 3 occupies Dmx channel 11 < 13

Finding Unused DMX Addresses

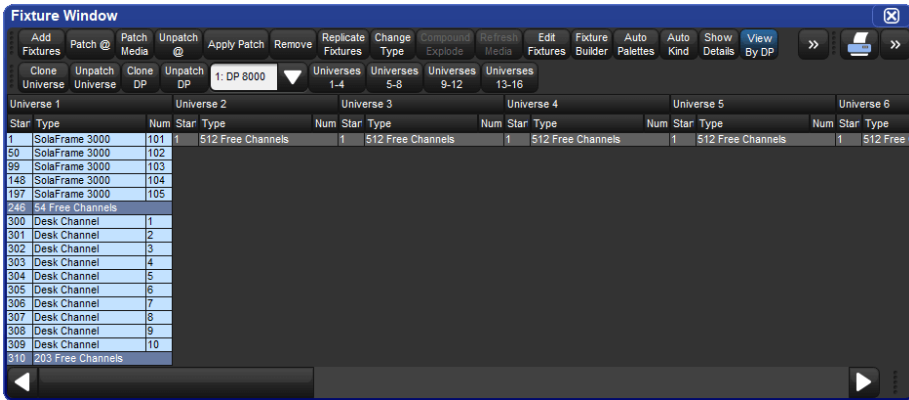

Figure 5.3. The View by DP view of the Fixture window

You can see an overview of all patched fixtures in the Fixture window by using View by DP; see Figure 5.3, “The View by DP view of the Fixture window”. This shows a spreadsheet with start address, fixture type and user number for each DMX universe. Additional rows show where there is an available space in the allocated DMX addresses. This is useful when you are patching additional fixtures and you need to know what ranges of DMX addresses are free. To show this view:

- Setup → Patch → View by DP : the View by DP button is on the toolbar at the top of the Fixture window.

You can use the buttons in the toolbar at the top of the window to view each group of four universes of a DMX Processor.

Deselect the View by DP button to return the Fixture window to its normal view.

Adding and Removing DMX Processors

All fixtures in the Hog 4 OS are patched to DP8000s. The Hog 4 OS automatically detects and makes available any connected DP800s for patching but if you want to patch fixtures to DP8000s that are not currently connected to the console, you must first add the DP8000s to the show:

1. Setup → Patch → Patch @ : open the Fixture Patch window. The Patch @ button is on the toolbar at the top of the Fixture window.
2. Press the Add button below the list of DP800s. The Add DP window will open:

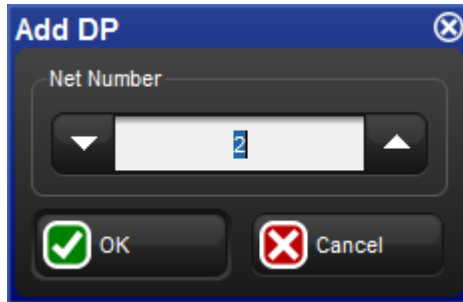

3. Assign a net number.
4. OK : close the Add DP window.
5. OK : close the Fixture Patch window.

To remove a DP8000 from a show file:

1. Setup → Patch → Patch @ : open the Fixture Patch window. The Patch @ button is on the toolbar at the top of the Fixture window.
2. Select the DP8000 you wish to remove from the show file.
3. Press the Remove button below the list of DP800s. A confirmation dialog will open. Press OK to unpatch and remove the DP8000.

Fixtures with Multiple DMX Patch Points

Some fixture types consist of several separate elements that work together, each with their own DMX address. An example is a par-can with a scroller, which operationally you want to treat as a single fixture ('a light that can change brightness and colour') but that physically consists of a dimmer-controlled lamp and a colour scroller that have

separate and often non-sequential patch points. Similarly, some moving fixtures such as the Vari*Lite VL5 consist of the moving head with its own control electronics, fed by an external dimmer. See *Figure 5.4, "Examples of Fixtures requiring Multiple Patch Points"*.

With such fixtures, there are two or more DMX start addresses, which may not be numerically adjacent, and indeed may be on different universes and DP800s. Hog 4 OS handles this by giving these fixtures multiple 'Patch Points', which you address separately in the Fixture Patch window.

For example, to patch the fixture with a scroller (of fixture type 'Scroller Dimmer') shown in *Figure 5.4, "Examples of Fixtures requiring Multiple Patch Points"*:

1. Setup → Patch : Open the Fixture window.
2. Fixture (Scroller Dimmer) 1 @ : Opens the Fixture Patch window.
3. Select the Fixture Patch Point (for the scroller) from the drop down list in the top right corner of the Fixture Patch window:

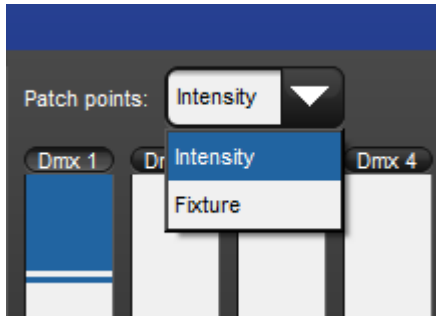

4. Click DMX 2 to select the second DMX universe.
5. [501] Enter : Enter the DMX address for the scroller.
6. Fixture (Scroller Dimmer) 1 @ : Opens the Fixture Patch window again.
7. Click DMX 4 to select the fourth DMX universe.
8. Select the Intensity Patch Point (for the dimmer) from the drop down list.
9. [2] Enter : Enter the DMX address for the dimmer.
10. Click on Apply Patch or close the Fixture window to send the new patch information to the DP8000s.

In the Fixture window, these types of fixture will span more than one row - one for each Patch point; see *Figure 5.5, "A Fixture with Multiple Patch Points"*.

Scroller Dimmer						
2	11		1: DP 8000	2: 23	Intensity	
			1: DP 8000	4: 420	Fixture	

Figure 5.5. A Fixture with Multiple Patch Points

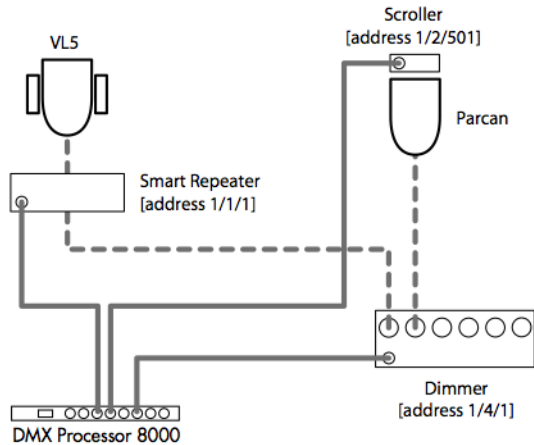

Figure 5.4. Examples of Fixtures requiring Multiple Patch Points

Cloning DMX Universes

Cloning patching copies fixture and associated patch information from one DMX universe to another. A selected fixture will therefore control recurring patch locations across several universes.

To clone the patching of one universe to another:

1. Setup → Patch → View by DP : open the Fixture window in View by DP view.
2. Select the universe to clone by clicking on the column in the spreadsheet. The selected universe is highlighted in blue.
3. Press Clone Universe. The Clone Universe window will open; see *Figure 5.6, "The Clone Universe window"*.
4. Select a destination DP8000 and universe. You can create a new DP8000 if you want to clone to a universe on a DP8000 not currently connected to the console, and you can specify an offset for the patch addresses to position them differently in the universe. Click on OK when you have finished.
5. Click on Apply Patch or close the Fixture window to send the new patch information to the DP8000s.



Figure 5.6. The Clone Universe window

If cloning will overwrite patch information in the destination, you will be asked for confirmation. The console will only unpatch previous fixtures that are in the way of new ones; the rest of the destination universe will be untouched.

**Tip**

You can also move patching from one universe to another by cloning the patch to the new universe, and then unpatching the old universe; see *Unpatching Fixtures from DMX Channels* (p. 131).

Cloning DMX Processors

You can copy fixture and associated patch information from one DP8000 to another by cloning a DP8000's patch. A selected fixture will then control recurring patch locations across several DP8000s.

To clone the patching of one DP8000 to another:

1. Setup → Patch → View by DP : open the Fixture window in View by DP view.
2. Select the DP8000 to clone by selecting it from the DP8000 drop down menu.

3. Press Clone DP. The Clone DMX Processor window will open; see *Figure 5.7, "The Clone DP window"*.
4. Select a source DP8000 from the source section of the window. Click Unpatch Source if you wish to move patch entries to the destination DP8000 instead of copying them.
5. Select a destination DP8000 from the destination section of the window. If there is conflicting patching on the destination DP8000 you can choose to unpatch only fixtures in conflict from the destination DP8000 or to unpatch all fixtures already patched to the destination.
6. You can create a new DP8000 if you want to clone to a universe on a DP8000 not currently connected to the console. Click the Add DP button.
7. Click OK.
8. Click on Apply Patch or close the Fixture window to send the new patch information to the DP8000s.



Figure 5.7. The Clone DP window

Unpatching Fixtures from DMX Channels

You can unpatch a fixture in order to re-patch it with a different start address, or to stop DMX output being sent to it. Unpatching does not erase any programming for the fixture in groups, palettes, cues and so on.

There are two ways to unpatch. Unpatching by fixture removes all patching information for that fixture, even if it has been patched to several start addresses or has multiple patch points. Unpatching by start address only unpatch a specific start address, leaving other start addresses associated with the fixture intact.

Unpatching by Fixture

To unpatch all patch information associated with a fixture:

1. Setup → Patch : open the Fixture window.
2. Select the fixture by clicking on it, then press Unpatch at the top of the Fixture window. This un-patches the fixture, but leaves all programming for the fixture intact.
3. Click on Apply Patch or close the Fixture window to send the new patch information to the DP8000s.

Or, using the command line:

1. Setup → Patch : open the Fixture window.
2. Fixture 1 Pig + @, Enter
3. Click on Apply Patch or close the Fixture window to send the new patch information to the DP8000s.

Unpatching by DMX Address

To unpatch a specific DMX start address you need to change the Fixture window to View by DP.:

1. Setup → Patch : open the Fixture window.
2. View by DP : change the Fixture window to View by DP.

When View by DP is selected, the Unpatch @ button is available on the top toolbar of the Fixture window. To unpatch start address 200 in the currently selected DMX universe (highlighted in blue):

- Unpatch @ **200**

To unpatch several start addresses:

- Unpatch @ **1/2/200 + 2/3/300**

To unpatch a range of start addresses:

- Unpatch @ **200 Thru 300** : un-patches all start addresses between 200 and 300.

To unpatch an entire universe:

1. Click or press on the universe to unpatch, so that it is highlighted in blue.
2. Press Unpatch Universe at the top of the Fixture window and confirm that you want to unpatch.

Click on Apply Patch or close the Fixture window to send the new patch information to the DP8000.

To unpatch an entire DP8000:

1. Select the DP8000 to unpatch from the drop-down list at the top of the Fixture window.
2. Press Unpatch DP, and confirm that you want to unpatch.

Click on Apply Patch or close the Fixture window to send the new patch information to the DP8000.

5.6.2 Patching Video Protocol Fixtures

Hog 4 OS supports direct control (via FixtureNet) of a variety of Ethernet based video switching devices as listed below:

- Barco MatrixPro-II SD/HD/3G-SDI 8x8, 16x16, 32x32
- Blackmagic Smart VideoHub 12x12, 20x20, 40x40
- Lightware MX 4x4, MX 6x6, MX 8x4, MX 8x8, MX 9x9, MX 12x12, MX 16x16
- AJA KUMO 16x16, 32x32

Each of these devices utilizes its own proprietary IP protocol for remote control, however, each device is patched and configured using the same Hog 4 OS procedure described below.

To patch and configure a video protocol fixture:

1. Setup → Patch : this opens the Fixture window.
2. Press the Patch Media button located at the top of the fixture window.
3. Select the dedicated tab for the video switcher type to be patched. If a dedicated tab for the video switcher is not shown in the media patch window, then the video switcher fixture has not yet been scheduled in the show.
4. Fill in the appropriate data for each of the listed fixtures and press okay. See below for addition info:
 - Node: the DP8000 whose FixtureNet port is connected to the same network as the video switcher's network port
 - Address: the IP address of the video switcher
 - Output: the physical output on the video switcher that the fixture will control



Figure 5.8. The Patch Media Window

**Caution**

Hog 4 PC supports the patching of video protocol devices but does not support their control via the local Ethernet adapter. Control of video protocol devices is supported on consoles and external DP8000s only.

5.7 Replicating Fixtures

You can expand your show to accommodate a larger rig using the Replicate Fixture function. This will create copies of fixtures, including all their programming. To replicate fixtures:

1. Setup → Patch : open the Fixture window.
2. Select one or more fixtures in the Fixture window by clicking on its numbered button in the left hand column.
3. Press Replicate Fixture, located in the toolbar at the top of the Fixture window.

Figure 5.9, “Fixture window, before and after replicating” shows the contents of the Fixture window before and after replicating fixtures.

The new fixtures are an exact copy of the originals, and will be added to every palette, cue and scene that contains programming for the original fixture. The comment cell shows you which fixture it is a copy of. New fixtures are given User Numbers that follow on sequentially from the original fixtures' numbers, but they are not patched or added to any groups. An asterisk will appear next to User Numbers that may now conflict with existing ones.

Studio Color 575												
1	21		1: DP	1: 104	Fixture		No	No	No	100%	Yes	No
2	22		1: DP	1: 120	Fixture		No	No	No	100%	Yes	No
Studio Spot CMY												
6	31		1: DP	1: 136	Fixture		No	No	No	100%	Yes	No
Studio Color 575												
1	21		1: DP	1: 104	Fixture		No	No	No	100%	Yes	No
2	22		1: DP	1: 120	Fixture		No	No	No	100%	Yes	No
11	23	Copy of 22					No	No	No	100%	Yes	No
Studio Spot CMY												
6	31		1: DP	1: 136	Fixture		No	No	No	100%	Yes	No

Figure 5.9. Fixture window, before and after replicating

5.8 Changing the Fixture Type

It is sometimes useful to change the type of a fixture, for example because of production changes where one fixture of one type is replaced by another of a different type, or because the rig has been changed, perhaps by adding a scroller to a desk channel fixture such as a Par. Hog 4 OS supports change type functionality between compound fixture types and standard fixture types, but does not support change type functionality between one compound fixture type and another compound fixture type. It is also important to note that when changing a compound fixture type to a standard fixture type, the original compound type is cloned (not changed) to a standard type fixture that is added to the show (the original compound type fixture and the new standard type fixture will exist side-by-side in the show and will have no reference to one another).

To change the fixture type:

1. Setup → Patch
2. Select the fixtures you want to change by clicking on the numbered button in the left-hand column.
3. Press the Change Type button and select the new fixture type from the list.
4. Hog 4 OS cannot change a fixture's type while it is patched. You will be asked if you want to unpatch any patched fixtures; don't forget to re-patch them afterwards.

Figure 5.10, “Changed Fixture Type” shows the contents of the Fixture window before and after changing the fixture type.



Important

Changing a fixture's type may cause ambiguities in any programming that has already taken place. Whilst Hog 4 OS translates all real world figure data, including colour and beam, between fixture functions, it cannot match the performance of a higher specification unit with a greater number of functions to that of a lower specification unit.

Fix	Num	Note	Df	Patr	Patch Ty	Patch Note	Swp Axes	Pan Invert	Tilt Invert	Intensity %	Col Cal	Parked
Studio Color 575												
1	1		1: DP	1: 1	Fixture		No	No	No	100%	Yes	No
Studio Spot 575												
1	1						No	No	No	100%		No

Figure 5.10. Changed Fixture Type

5.9 Removing a Fixture from the Show

To remove a fixture:

1. Setup → Patch : open the Fixture window.
2. Fixture 1 Remove : Select the fixture(s) you want to remove, and press Remove.
3. You will be asked to confirm. Select OK.



Important

If you remove a fixture, all of its associated programming in groups, palettes, cues and so on will be removed from the show. To disable a fixture while retaining its programming, unpatch it; see *Unpatching Fixtures from DMX Channels* (p. 131).

5.10 Creating Palettes and Groups Automatically

Hog 4 OS can create groups and palettes automatically, based on the fixtures in your show. This rapidly gives you a set of 'building blocks' to start programming with. To use the Auto Palettes function:

1. Setup → Patch : open the Fixture window.
2. Click on the Auto Palettes button (located in the toolbar at the top of the Fixture window) and select from the options in the Auto Palettes window; see *Figure 5.11, "The Auto Palettes window"*.
3. Click on Generate.

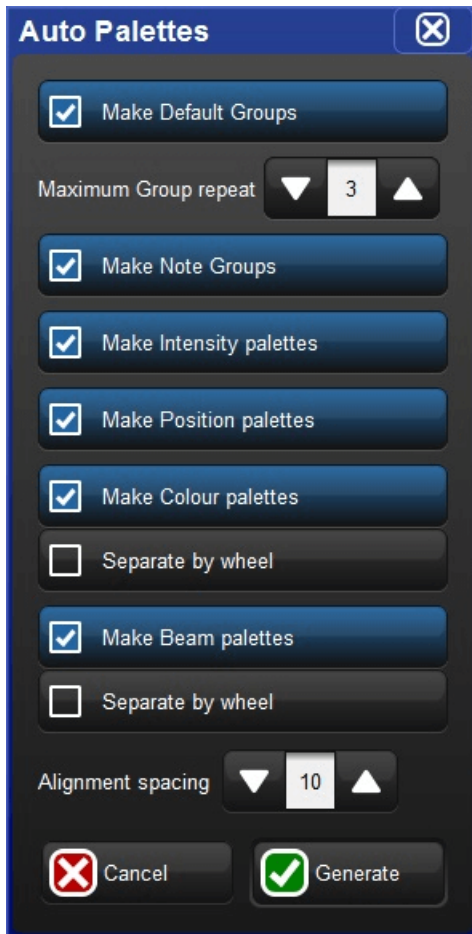

Figure 5.11. The Auto Palettes window

You can choose to have the console automatically make:

- **Groups:** If the Make Default Groups button is depressed, the console will make groups for each fixture type. You can specify the repeat multiple for the groups to be created. For example, with a value of 3 Group 1 will contain fixtures 1, 4, 7, 10..., Group 2 fixtures 2, 5, 8, 11..., Group 3 fixtures 3, 6, 9, 12.... If the Make Note Groups button is depressed, the console will generate groups based on any notes that have been added to fixtures in the fixture window. A single fixture can have multiple notes (single notes are separated by commas in the notes field) and as a result will be included in multiple groups auto-generated by the "make note groups" feature.
- **Intensity Palettes:** If the Make Intensity Palettes button is depressed, the console will make intensity palettes.

- **Position Palettes:** If the Make Position Palettes button is depressed, the console will make position palettes.
- **Colour Palettes:** If the Make Colour Palettes button is depressed, the console will make colour palettes. If you press the adjacent Separate by Wheel button, the console will create separate colour palettes for each colour wheel in fixtures that have more than one. This ensures that you can use the palettes to program looks that use both wheels simultaneously, without the palettes conflicting with each other. Auto generated Colour palettes that make use of colour mixing information will automatically have their buttons colour coded with appropriate custom colour selections.
- **Beam Palettes:** If the Make Beam Palettes button is depressed, the console will make beam palettes. If you press the adjacent Separate by Wheel button, the console will create separate beam palettes for each beam effect wheel in fixtures that have more than one. This ensures that you can use the palettes to program looks that use both wheels simultaneously, without the palettes conflicting with each other.

The Auto Palettes window also allows you to choose the alignment spacing of the palette's directory window. The alignment spacing controls how many palettes are displayed across the directory window; for example 6 for a half screen window, 12 for a full screen window.

For more information on groups and palettes, see *Groups (p.177)* and *Palettes (p.181)*.

5.11 Configuring Fixtures

Each fixture has a variety of settings that control how Hog 4 OS handles it. Settings that control how the fixture as a whole behaves are configured in the Fixture window, while settings that are specific to individual parameters are configured in the Edit Fixtures window.

5.11.1 Fixture Configuration

In addition to a fixture's patch information, the Fixture displays a number of important fixture attributes which are organized into separate columns. Some of these attributes are editable while others are read-only.

Note

Notes can be used to create a note(s) for a fixture, such as its location or intended use. Notes can also be used when auto-generating palettes to quickly create groups based on notes.

To add a note to a fixture:

1. Open + Fixture
2. Select the fixture's Note cell.
3. Set **[text of note]** Enter : Type in the note text.



Tip

Fixture notes can be displayed in editors such as the Programmer, but this is turned off by default. To display notes, right click on any column header in the editor, and select Note.

Patch Note

Patch Notes can be used to attach a comment to a fixture regarding its patching.

To add a Patch Note:

1. Open + Fixture
2. Select the fixture's Patch Note cell.
3. Set **[text of note]** Enter : Type in the note text.

IP Address

The IP address column displays the fixture's IP address which is currently used for CITP and Video Patch records. The IP address column is read-only and is hashed out for fixtures that are not CITP capable or video patch capable.

Preview Package

When the "show details" button is enabled at the top of the Fixture window a column labeled Preview Package will appear. The preview package column allows the user to view/modify the selected preview package for a fixture. This is useful when there is a need to switch a fixture between a cached CITP preview package, a customized preview package, and/or the default library preview package for that fixture type.

Icon

When the "show details" button is enabled at the top of the Fixture window a column labeled Icon will appear. The icon column allows the user to view/modify the icon assigned to the fixture. Icons are used to represent the fixture when it is added to plots. Some fixtures in the fixture library already have an icon pre-defined for their fixture type when scheduled but can be customized by the user once scheduled.

Size

When the "show details" button is enabled at the top of the Fixture window a column labeled Size will appear. The size column allows the user to view/modify the fixture's icon size. This is most useful when adding the fixture to plots.

Color

When the "show details" button is enabled at the top of the Fixture window a column labeled Color will appear. The color column allows the user to view/modify the color assigned to a fixture. Color coding a fixture can help to make it easier to identify in the plot window.

Swap Axes

Depending on a fixture's orientation in the rig, you may want to swap its pan and tilt axes. For example, if units are rigged facing across the stage rather than facing up or down stage, then swapping the axes keeps the Trackball movement and the fixture movement the same. This also ensures that fixtures selected in groups all move in the same direction as the Trackball is moved.

Fixtures that are rigged in other positions, for example on the stage floor as opposed to hanging, then combinations of swap axes and pan invert and/or tilt invert may be required.

To swap axes:

1. Open + Fixture
2. Scroll to the desired fixture, and select its SwpAxes cell.
3. Press Set, and choose Swap to swap axes.

Pan Invert / Tilt Invert

Depending on a fixture's orientation in the rig, you may want to invert its pan and/or tilt moment. For example, if units are rigged on the stage floor as opposed to hanging, then a pan and/or tilt invert may be required.

To invert pan and/or tilt:

1. Open + Fixture
2. Scroll to the desired fixture, and select either its Pan Invert or Tilt Invert cell.
3. Press Set, and choose Yes to invert the axis.

Intensity % (proportional patch)

You can use intensity percentage (also know as proportional patching) to change the intensity value output by the console to a fixture, relative to the intensity value that has been programmed. All intensity values for the fixture are reduced in proportion, so that with a proportional patch of 80%, a programmed intensity of 100% would be output as an intensity of 80%, and one of 50% would be output as 40%. You can use this to limit the maximum intensity of a fixture so that it never goes above 80%, for example, by assigning the proportional patch to 80%. Please note that reductions to the output of a fixture caused by changes to the intensity % value are not reflected in the values shown

in the output window. This is because reductions to the fixtures intensity output are calculated in dmx only and therefore can only be viewed in the dmx output window.

To assign a fixture's intensity % (proportional patch):

1. Open + Fixture
2. Select the Intensity % cell for the fixture required.
3. Set, [**percentage**], Enter : enter a percentage.
4. To return the proportional patch to normal, assign the value to 100%.

You can assign a proportional patch value of above 100%. For example, if you patch at 200%, the intensity value that the console outputs will be twice that programmed. A programmed value of 25% will give 50% output, and 50% will give 100%. Programmed levels above 50% will not, regrettably, give fixture intensities above 100%.

Note that if you proportionally patch a fixture, its intensity will still be displayed on the console in the range 0 to 100%, even though the output value will be varying over the range defined by the proportional patch value.

Colour Calibration

When the "show details" button is enabled at the top of the fixture window a column labeled Col Cal will appear and shows whether the fixture has colour calibration data in the fixture library. You cannot edit this column, but it is useful to be able to check if the fixture is colour calibrated when working with the Colour Picker; see *Working with Colour* (p.162).

Parked

When the "show details" button is enabled at the top of the Fixture window a column labeled Parked will appear and shows whether the fixture has any of its parameters parked in output. You cannot edit this column, but it is useful to be able to check if the fixture is parked.

5.11.2 Parameter Configuration

You can configure settings that are specific to individual parameters in the Edit Fixtures window (Figure 5.12, "The Edit Fixtures window"):

- Setup → Patch → Edit Fixtures

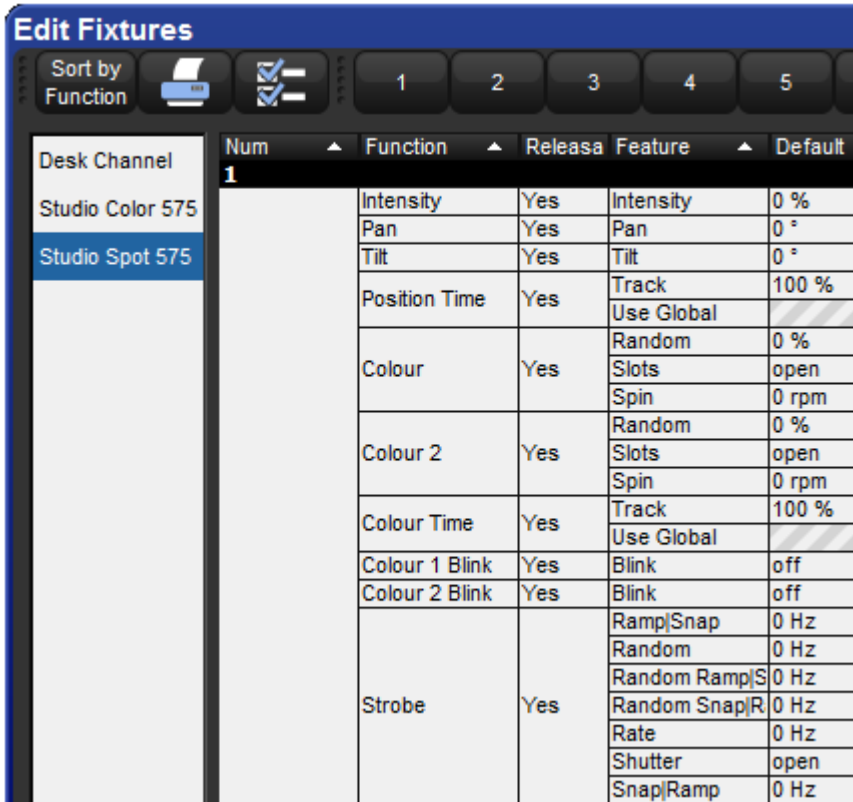

Figure 5.12. The Edit Fixtures window

You can select a fixture type from the list on the left hand side of the window. The main part of the window then shows the configurable settings for each fixture of that type. The numbered buttons in the Jump Toolbar at the top of the window take you quickly to a particular fixture of that type.

Pressing the Sort by Function button in the top left of the window changes the view, so that the main list groups each parameter together for all the fixtures of the type selected in the list. This is often the easiest way to work in the window, as you can easily click or press and then drag to select a range of cells to edit. For example, you could assign in one action the default value for the pan parameter of all the Studio Color 575 fixtures in the show; see Figure 5.13, “The Edit Fixtures window sorted by Function”.

Desk Channel	Num	Release	Feature	Default	Min	Max	Max Soe	Offset	Default P	Slot 1	Slot 2	Slot 3	Slot 4	Slot 5	Slot 6
Studio Color 575	1	Yes	Random	0 %	0 %	100 %	0 s	0 %	Linear	open	triring	lava	stars	wavycon	shatters
			Slots	open											
Studio Spot 575	1		Spin	0 rpm	-300 rpm	300 rpm	0 s	0 rpm	Linear						
			Random	0 %	0 %	100 %	0 s	0 %	Linear						
	2	Yes	Slots	open						open	triring	lava	stars	wavycon	shatters
			Spin	0 rpm	-300 rpm	300 rpm	0 s	0 rpm	Linear						
			Random	0 %	0 %	100 %	0 s	0 %	Linear						
	3	Yes	Slots	open						open	triring	lava	stars	wavycon	shatters
			Spin	0 rpm	-300 rpm	300 rpm	0 s	0 rpm	Linear						
			Random	0 %	0 %	100 %	0 s	0 %	Linear						
	4	Yes	Slots	open						open	triring	lava	stars	wavycon	shatters
			Spin	0 rpm	-300 rpm	300 rpm	0 s	0 rpm	Linear						
			Random	0 %	0 %	100 %	0 s	0 %	Linear						
	5	Yes	Slots	open						open	triring	lava	stars	wavycon	shatters
			Spin	0 rpm	-300 rpm	300 rpm	0 s	0 rpm	Linear						
			Random	0 %	0 %	100 %	0 s	0 %	Linear						
	6	Yes	Slots	open						open	triring	lava	stars	wavycon	shatters
			Spin	0 rpm	-300 rpm	300 rpm	0 s	0 rpm	Linear						
			Random	0 %	0 %	100 %	0 s	0 %	Linear						
	7	Yes	Slots	open						open	triring	lava	stars	wavycon	shatters
			Spin	0 rpm	-300 rpm	300 rpm	0 s	0 rpm	Linear						
			Random	0 %	0 %	100 %	0 s	0 %	Linear						
	8	Yes	Slots	open						open	triring	lava	stars	wavycon	shatters
			Spin	0 rpm	-300 rpm	300 rpm	0 s	0 rpm	Linear						

Figure 5.13. The Edit Fixtures window sorted by Function

Assigning Minimums and Maximums for Parameters

When fixtures are placed close to obstacles, such as trussing or set pieces, it may be important to limit movement to prevent accidental damage, especially when the fixture is out of view of the operator. However, other functions can also be limited, for example to implement a house or event policy on the use of strobe lighting.

Note that limits can only be assigned for continuous parameters, not slotted ones.

To assign limits:

1. Setup → Patch → Edit Fixtures
2. Select the Minimum cell of the parameter you wish to limit.
3. Set, [**new value**], Enter : Enter a value as a real world unit. In the case of pan and tilt, it will be a plus or minus number of degrees from the fixture's default position.
4. Repeat to assign the Maximum value.

Assigning a Custom Default

The default value is the value that the parameter will take when no playbacks or editors are controlling it. Fixtures also go to their default setting when the console starts up.

To assign a custom default:

1. Setup → Patch → Edit Fixtures
2. Select the Default cell of the desired parameter.
3. Set, [**new value**], Enter : Enter a value as a real world unit.

Assign a Parameter Offset

This setting allows you to offset the range of values over which a parameter varies. For instance if one fixture is hung at an angle to the bar, so that it has a different pan centre-point from all the others on that bar, then you could assign an offset so that the fixture appeared to line up from a programming and operating point of view.

To assign a parameter offset:

1. Setup → Patch → Edit Fixtures
2. Select the Offset cell of the desired parameter.
3. Set, [**new value**], Enter : Enter a value as a real world unit.



Important

Applying an offset to a parameter after you have programmed values for it into your show will mean that those values will also be offset.

Naming Slots

Some fixture parameters are continuously variable, for example CMY colour mixing. On the other hand some parameters, for example gobo or colour wheels, work in discrete increments or 'slots'.

The Fixture Library loaded into Hog 4 OS defines the fixture's default slots, displayed on the Slot Toolbar, in palettes and the Programmer. When custom gobos or colours are used, you can customise the show file to display a suitable name for each gobo or colour slot, chosen from those in the fixture library.

To name a slot parameter:

1. Setup → Patch → Edit Fixtures
2. For the desired fixture, scroll right and select the Slot cell for the parameter required.
3. Press Set, select the desired slot name from the list, and press Enter.

Releasable Parameters

Fixture parameters move to their default values when they are released. You can prevent specific fixture parameters from returning to their default values, so that they hold their current value until they are assigned to a new programmed value:

1. Setup → Patch → Edit Fixtures : open the Edit Fixtures window.
2. Click on the Releasable cell for the required fixture parameter.
3. Press the Set key to assign the fixture parameter to be releasable or not as required.

5.12 Auto-Patch

Auto-patch is an easy way to quickly detect and patch fixtures that are connected and properly configured on the console's FixtureNet port. The following fixtures are currently supported by Hog 4 OS for auto-patch:

Arkaos MediaMaster (Software v5.0.3, 5.2.2, 5.3.1)

High End Systems Axon HD (Software v1.0.3)

High End Systems Axon HD Pro (Software v1.0.3)

High End Systems DL.HD (Software v1.0.3)

High End System MMS-100 (Software v1.0.3)



Caution

The IP address of the fixture/mediaserver must be set within subnetwork of the Hog console's FixtureNet port. Failing to do so will result in the fixture/mediaserver not being detected. If the fixture/mediaserver is set to obtain an IP address using DHCP and no DHCP server is present, users are advised to set the console's fixture net port to 169.254.1.1 with a netmask of 255.255.0.0 which will ensure auto-IP compatibility.

To auto-patch fixtures connected to the console's FixtureNet network:

1. Open the Fixture Window.
2. Click on the "Auto-Patch" button.
3. The console will begin searching for fixtures that are auto-patch compatible. Once the search is complete a list of auto-patchable fixtures will appear in the "select fixtures to auto-patch" window.
4. Select the fixtures you wish to auto-patch and press okay.
5. Hog 4 OS will use the information supplied by the fixtures to:
 - Schedule the fixtures.
 - Patch the fixtures to the appropriate dmx channels using the lowest available Hog universe.
 - Establish an ArtNet output mapping to the fixture in the art-net outputs tab of the DP8000 node settings window.
6. If conflicts exist between the show's current patch and the fixture's settings, Hog 4 OS will complete as much of the auto-patch as possible and display a warning message for any part of the process that did not succeed.

Section 6: Selecting Fixtures and Modifying Parameters

6.1 Selecting Fixtures

There are three ways to select fixtures: using the **command line** with the numeric keypad, visually selecting and clicking on the fixture's number in the programmer, or by selecting groups from the groups directory.

6.1.1 Selecting Single Fixtures

To select a single fixture visually in the programmer or other open editor, click on the fixture's number in the Num column of the spreadsheet.

To select a single fixture using the command line type the fixture's user number using the keypad and then press enter. For example, to select Studio Color number 1. If more than one fixture in the show file has the same user number then you must first specify the fixture type as demonstrated below.

For fixtures with dotted user numbers enter the whole number part of the user number to select all user numbers that match the whole number. If you want to select a specific dotted numbered fixture enter the entire user number including the whole number, the dot, and the part number. For complete details on selection syntax with dotted user numbers see *Selecting fixtures with dotted user numbers (p.148)*.

- Fixture, (Studio Color 575), 1 : when you press the Fixture key, types of available fixtures will appear at the bottom of the right hand touch screen, where you can select (Studio Color 575):



Hog 4 OS maintains the type of the last fixture selected. If, for example, Studio Colors are selected then all fixture numbers entered into the command line will refer to Studio Colors until a new fixture type is selected.



Tip

Repeated pressing of the Fixture key will cycle through the available fixture types.

Note that throughout this manual, the examples generally assume that you have assigned user numbers so that they are unique.

6.1.2 Selecting Multiple Fixtures

You can select more than one fixture using the +, - and Thru keys. For example:

1+5, Enter : selects fixtures 1 and 5.

1Thru5, Enter : selects fixtures 1 to 5.

1Thru5- 4 : selects fixtures 1 to 5, but not 4.

1Thru5+7 : selects 1 to 5 and also 7.

5ThruEnter : selects from fixture 5 of the current type through to the last fixture of the current type.

ThruEnter : selects all fixtures of the current type.

Note that selections are cumulative, building the total selection, until the selection is used to perform an action on the selected fixtures. After that, subsequent selections start from nothing, unless you use + or - to add or subtract from the previous selection.



Tip

To select all fixtures of a particular type, press the Fixture key then Pig + (Fixture type) from the toolbar at the bottom of the right-hand touch screen.

6.1.3 Selecting fixtures with dotted user numbers

Selecting fixtures with dotted user numbers can be done in a variety of ways. The tables listed in this section demonstrate all of the supported selection syntax mechanisms supported by the Hog 4 OS for fixtures with dotted user numbers.

The following examples assume all of the fixtures on the right hand side of the table are scheduled in the show while the user numbers highlighted in blue are fixtures that have been selected as a result of the syntax entered on the left hand side of the table:

start	end	result				
12		11	12	13	14	15
		11.1	12.1	13.1	14.1	15.1
		11.2	12.2	13.2	14.2	15.2
		11.3	12.3	13.3	14.3	15.3
		11.4	12.4	13.4	14.4	15.4
		11.5	12.5	13.5	14.5	15.5
		<i>single/all</i>				
12 > 14		11	12	13	14	15
		11.1	12.1	13.1	14.1	15.1
		11.2	12.2	13.2	14.2	15.2
		11.3	12.3	13.3	14.3	15.3
		11.4	12.4	13.4	14.4	15.4
		11.5	12.5	13.5	14.5	15.5
		<i>range/all</i>				
12 >		11	12	13	14	15
		11.1	12.1	13.1	14.1	15.1
		11.2	12.2	13.2	14.2	15.2
		11.3	12.3	13.3	14.3	15.3
		11.4	12.4	13.4	14.4	15.4
		11.5	12.5	13.5	14.5	15.5
		<i>start/all</i>				
> 14		11	12	13	14	15
		11.1	12.1	13.1	14.1	15.1
		11.2	12.2	13.2	14.2	15.2
		11.3	12.3	13.3	14.3	15.3
		11.4	12.4	13.4	14.4	15.4
		11.5	12.5	13.5	14.5	15.5
		<i>end/all</i>				

Figure 6.1. All Portion Selections

start	end	result				
12 .		11	12	13	14	15
		11.1	12.1	13.1	14.1	15.1
		11.2	12.2	13.2	14.2	15.2
		11.3	12.3	13.3	14.3	15.3
		11.4	12.4	13.4	14.4	15.4
		11.5	12.5	13.5	14.5	15.5
<i>single/master</i>						
12 > 14 .		11	12	13	14	15
12 . > 14		11.1	12.1	13.1	14.1	15.1
12 . > 14 .		11.2	12.2	13.2	14.2	15.2
		11.3	12.3	13.3	14.3	15.3
		11.4	12.4	13.4	14.4	15.4
		11.5	12.5	13.5	14.5	15.5
<i>range/master</i>						
12 > .		11	12	13	14	15
12 . >		11.1	12.1	13.1	14.1	15.1
		11.2	12.2	13.2	14.2	15.2
		11.3	12.3	13.3	14.3	15.3
		11.4	12.4	13.4	14.4	15.4
		11.5	12.5	13.5	14.5	15.5
<i>start/master</i>						
	> 14 .	11	12	13	14	15
		11.1	12.1	13.1	14.1	15.1
		11.2	12.2	13.2	14.2	15.2
		11.3	12.3	13.3	14.3	15.3
		11.4	12.4	13.4	14.4	15.4
		11.5	12.5	13.5	14.5	15.5
<i>end/master</i>						

Figure 6.2. Whole Portion Only Selections

Section 6: Selecting Fixtures and Modifying Parameters

start	end	result				
12 . 2		11	12	13	14	15
		11.1	12.1	13.1	14.1	15.1
		11.2	12.2	13.2	14.2	15.2
		11.3	12.3	13.3	14.3	15.3
		11.4	12.4	13.4	14.4	15.4
		11.5	12.5	13.5	14.5	15.5
<i>single/single</i>						
12 > 14 . 2 12 . 2 > 14		11	12	13	14	15
		11.1	12.1	13.1	14.1	15.1
		11.2	12.2	13.2	14.2	15.2
		11.3	12.3	13.3	14.3	15.3
		11.4	12.4	13.4	14.4	15.4
		11.5	12.5	13.5	14.5	15.5
<i>range/single</i>						
12 > . 2		11	12	13	14	15
		11.1	12.1	13.1	14.1	15.1
		11.2	12.2	13.2	14.2	15.2
		11.3	12.3	13.3	14.3	15.3
		11.4	12.4	13.4	14.4	15.4
		11.5	12.5	13.5	14.5	15.5
<i>start/single</i>						
> 14 . 2		11	12	13	14	15
		11.1	12.1	13.1	14.1	15.1
		11.2	12.2	13.2	14.2	15.2
		11.3	12.3	13.3	14.3	15.3
		11.4	12.4	13.4	14.4	15.4
		11.5	12.5	13.5	14.5	15.5
<i>end/single</i>						

start	end	result				
12 . 2 > . 4		11	12	13	14	15
		11.1	12.1	13.1	14.1	15.1
		11.2	12.2	13.2	14.2	15.2
		11.3	12.3	13.3	14.3	15.3
		11.4	12.4	13.4	14.4	15.4
		11.5	12.5	13.5	14.5	15.5
<i>single/range</i>						
12 . 2 >		11	12	13	14	15
		11.1	12.1	13.1	14.1	15.1
		11.2	12.2	13.2	14.2	15.2
		11.3	12.3	13.3	14.3	15.3
		11.4	12.4	13.4	14.4	15.4
		11.5	12.5	13.5	14.5	15.5
<i>single/start</i>						
12 . > . 3		11	12	13	14	15
		11.1	12.1	13.1	14.1	15.1
		11.2	12.2	13.2	14.2	15.2
		11.3	12.3	13.3	14.3	15.3
		11.4	12.4	13.4	14.4	15.4
		11.5	12.5	13.5	14.5	15.5
<i>single/end</i>						
12 . 2 > 14 . 4		11	12	13	14	15
		11.1	12.1	13.1	14.1	15.1
		11.2	12.2	13.2	14.2	15.2
		11.3	12.3	13.3	14.3	15.3
		11.4	12.4	13.4	14.4	15.4
		11.5	12.5	13.5	14.5	15.5
<i>range/range</i>						

Figure 6.3. Part Portion Selections

start	end	result				
12 . 0		11	12	13	14	15
		11.1	12.1	13.1	14.1	15.1
		11.2	12.2	13.2	14.2	15.2
		11.3	12.3	13.3	14.3	15.3
		11.4	12.4	13.4	14.4	15.4
		11.5	12.5	13.5	14.5	15.5
<i>single/cells</i>						
12 > 14 . 0		11	12	13	14	15
12 . 0 > 14		11.1	12.1	13.1	14.1	15.1
12 . 0 > 14 . 0		11.2	12.2	13.2	14.2	15.2
		11.3	12.3	13.3	14.3	15.3
		11.4	12.4	13.4	14.4	15.4
		11.5	12.5	13.5	14.5	15.5
<i>range/cells</i>						
12 > . 0		11	12	13	14	15
12 . 0 >		11.1	12.1	13.1	14.1	15.1
		11.2	12.2	13.2	14.2	15.2
		11.3	12.3	13.3	14.3	15.3
		11.4	12.4	13.4	14.4	15.4
		11.5	12.5	13.5	14.5	15.5
<i>start/cells</i>						
	> 14 . 0	11	12	13	14	15
		11.1	12.1	13.1	14.1	15.1
		11.2	12.2	13.2	14.2	15.2
		11.3	12.3	13.3	14.3	15.3
		11.4	12.4	13.4	14.4	15.4
		11.5	12.5	13.5	14.5	15.5
<i>end/cells</i>						

Figure 6.4. Part Portion Selections with .0



Tip

Open ended fixture selections stop when a break (gap) in the whole portion of the user numbers is detected. In addition, open ended selections made

within a range of part number portions will stop if a break (gap) is discovered in the part number portion of the selection.

6.1.4 Select All

You can select all the fixtures in the Programmer by pressing the ALL key on the front panel of the console or by using the All button on the Select Toolbar. For example:

1. Studio Colors 1 to 5 are in the Programmer, but not selected.
2. Main Toolbar → Select : open the Select Toolbar
3. All : the selection is now Studio Colors 1 to 5.



Figure 6.5. The Select Toolbar

6.1.5 Inverting the Selection

You can invert the current selection of fixtures so that the fixtures in the editor that were previously *not* selected become the new selection. For example:

1. Studio Colors 1 to 5 are in the Programmer.
2. Fixture 1 + 3 + 5 : select Studio Colors 1, 3 and 5:

Studio Color 575		
1	100%	
2	100%	
3	100%	
4	100%	
5	100%	

3. Main Toolbar → Select : open the Select Toolbar
4. Invert : the selection is now Studio Colors 2 and 4:

Studio Color 575		
1	100%	
2	100%	
3	100%	
4	100%	
5	100%	

6.1.6 Sub Selections

Sub selections can be made from within the current selection, using the Next and Back keys, and the Odd, Even and Random buttons on the Select Toolbar:

- Main Toolbar → Select

Random: The Random button selects a single fixture at random from the current active selection in the Programmer.

Even and Odd: The Even and Odd buttons on the Select Toolbar select the even and odd fixtures from the current selection, according to the *Selection Order* (p.156). Note that the selection order is not related to fixture user numbers, so the sub selection produced by Odd might contain even-numbered fixtures.

Pig + Even and Odd: To select even or odd fixtures from the current selection based upon fixture user numbers, use Pig + Even or Pig + Odd. For fixtures with dotted user numbers, only the whole number portion of the user number is considered when determining odd and even selections when pig is held down.

Next and Back: The Next and Back keys on the console select a single fixture (or fixture part) from within the current selection. Repeatedly pressing Next or Back steps forwards or backwards through the current selection, with the order determined by the *Selection Order* (p.156).

Group + Next and Back: Holding Group while pressing the Next and Back keys on the console selects the next/previous segment of fixtures as established by the segments and buddying parameters. For example if 16 fixtures are selected in segments of 4, and "next by segment" is turned on, then holding Group while pressing Next will select fixtures 1<4, then 5<8, and so on. If "next by segment" is turned off, then holding Group while pressing Next will select a fixture from each of the four segments.

Fixture + Next and Back: Holding Fixture while pressing the Next and Back keys on the console selects the next/previous whole number fixture (and any applicable fixture parts) within the current fixture selection.

Dot + Next and Back: Holding down the dot (period) key while pressing the Next and Back keys on the console selects the next/previous fixture part of the currently selected whole number fixture(s).



Tip

When the Trackball is in position mode, the bottom left Trackball key also acts as a Next key. This can make it very fast to work through a selection of fixtures assigning their position.

6.1.7 Lateral Selections

Lateral selections can only be used for fixtures in the show that have dotted user numbers (1.1, 1.2, etc). Much like sub selections, lateral selections are based on the current selection. However, unlike sub-selections, lateral selections do not select fixtures within the current selection. Instead, lateral selections compare the whole number portions of the currently selected fixtures to other fixtures in the show to make a new selection. The table below shows six lateral selection syntaxes that can be used:

Syntax	Result
(.) (enter)	Selects fixtures in the show that have a whole number portion that matches the whole number portion of any fixtures in the current selection but will not select the fixture if it has a part number portion. This is primarily used to allow users to select the main or master portion of a compound fixture.
(.) (.) (enter)	Selects fixtures in the show that have a whole number portion that matches any whole number portion of any fixtures in the current selection.
(.) (#) (enter)	Selects fixtures in the show with user numbers that match the whole numbers portions of the current fixture selection and that contain the specified dotted part number.
(.) (#) (thru) (.) (#) (enter)	Selects fixtures in the show with user numbers that match the whole number portions of the current fixture selection and that fall within the specified part number range.
(.) (0) (enter)	Selects fixtures in the show with user numbers that match the whole number portions of the current fixture selection and that have a part number. If the fixture doesn't have a part number it won't be selected.
(thru) (.) (#)	Selects fixtures in the show with user numbers that match the whole number portions of the current fixture selection and that fall within the specified open ended part number range.



Tip

Lateral selections are not additive selections; they are new selections. This means that regardless of whether or not an edit has been made to the current selection, making a lateral selection will start a completely new selection unless (+) is used when making the lateral selection in which case the lateral selection will be added to the current selection.

6.1.8 Deselecting Fixtures

To deselect all selected fixtures, press the Backspace key when the command line is empty.

To deselect specific fixtures, use the – key:

- – Fixture 1 : deselects Fixture 1.

Alternatively, you can deselect a fixture visually in the Programmer or editor window by clicking on its number in the Num column.

6.1.9 Reselecting Fixtures

You can recall the last sub selection made before deselecting fixtures by pressing Previous on the Select Toolbar.

6.2 Selection Order

The order in which you select fixtures is significant in controlling how fanning and effects are applied to them; see *Fanning* (p.170) and *Effects* (p.257). For example, applying a fan or effect after selecting fixtures 1-5 can appear different than if you selected fixtures 1 + 3 + 2 + 4 + 5.

The selection order is relevant during programming, and is recorded as part of groups, but it is not recorded in palettes, cues or scenes.



Tip

Because the console records the selection order as part of groups, you can select the group and use the Next and Back keys to sub-select each fixture in a particular order. By controlling the selection order when you record the group, you can then work through a series of fixtures in the order they are physically positioned in the rig, instead of in numerical order.

6.2.1 Reverse, Shuffle and Reorder

You can change the selection order of fixtures in predefined ways. The Reverse, Shuffle, and Reorder buttons are on the Select Toolbar and Fanning Toolbar:

- Main Toolbar → Select : open the Select Toolbar.

Reverse: reverses the selection sequence, so that the last is first and the first is last. For example, the fixture selection 1-5 becomes 5-1.

Shuffle: randomises the selection order of the current selection. For example, the fixture selection 1-5 becomes 3 + 5 + 2 + 1 + 4.

Reorder: sorts the selection order to match the User Number order. For example, the fixture selection 3 + 5 + 2 + 1 + 4 becomes 1-5.



Tip

The Reverse, Shuffle, and Reorder buttons can also be found on the Fanning Toolbar, which you can open by pressing and holding the Fan key. See *Fanning* (p.170).

6.3 Modifying Parameters

Once fixtures are selected within an editor, you can modify their parameters.

Hog consoles provide several ways to adjust the different parameter types:

- **Command Line:** Use for intensity and selecting palettes.
- **I-Wheel:** Use for intensity.
- **Trackball:** Use for position (pan and tilt). Use the top-right Trackball key to switch the Trackball between controlling the on-screen pointer and the position of selected fixtures.
- **Parameter Wheels:** Use for all fixture functions. To change the parameter type currently controlled by the parameter wheels, select one of the fixed kind keys on the front panel: Intensity, Position, Colour, Beam, Effect, and Time or one of the user kind keys on the front panel. For consoles that don't have a dedicated user kind keys on the front panel you may select user kinds using the kinds directory as long as the guard button for the kinds directory is turned off.

If the fixture has more parameters of a particular type than there are parameter wheels you can press the parameter type keys to page through the parameters.

- **Center Wheel:** Functions assigned to the center wheel in the user preferences can be adjusted using the inner wheel and outer jog shuttle controls of the center wheel. (Hog 4 Console Only)
- **Slot Toolbar:** Use for parameters that have discrete rather than continuous values (known as 'slotted'), such as the positions of a colour wheel. This gives you button-press control of the possible values.

The Slot Toolbar also has buttons to access the control functions: Enable, Mode and Control.

- **Spreadsheet:** You can directly edit a parameter's value in an editor's spreadsheet view. Click on the cell, press Set, type in a value and press Enter.
- **Colour Picker:** You can assign **hue** and **saturation** values for a fixture's colour using the Colour Picker. See *The Colour Picker* (p.164).
- **Gel Picker:** You can assign the colour of fixtures to match a colour filter from various manufacturers' ranges using the Gel Picker. See *The Gel Picker* (p.165).

6.3.1 Intensity

Fixture intensities can either be assigned from the keypad or using the I-Wheel, as well as the parameter wheels and by editing directly in the editor spreadsheet.

With the @ Key

To assign intensities using the @ key and the numeric keypad:

- Fixture **4 @ 70**, Enter : assigns Fixture 4 to 70%.
- Fixture **4 @ 5**, Enter : assigns Fixture 4 to 50% (not 5%).

- Fixture 4 @ 05, Enter : assigns Fixture 4 to 5%.

To assign fixtures to full or zero:

- Fixture 4 Full : assigns Fixture 4 to full.
- Fixture 4 Out : assigns Fixture 4 to zero. The Out button is on the Main Toolbar.

The intensity of a fixture can be changed relative to its current level, for example:

- Fixture 4 @ + 5, Enter : increases the intensity of Fixture 4 by 50%.
- Fixture 4 @ - 10, Enter : reduces the intensity of Fixture 4 by 10%.

The intensity of a fixture can be scaled proportionally, for example:

- Fixture 4 @ / 70, Enter : scales the intensity of Fixture 4 to 70% of its original value.
- Fixture 4 @ / 120, Enter : scales the intensity of Fixture 4 to 120% of its original value.

With the i-Wheel;

On the Hog 4 Console and on Hog 4 PC only: Moving the I-Wheel changes the level of the selected fixtures. When selecting several fixtures and adjusting levels, the wheel will maintain relative differences between them, so that all intensities change by the same amount. For example, if fixture 1 is at 10%, 2 at 50% and the wheel is increased by 10%, then fixture 1 will move to 20% and 2 will move to 60%.

By holding the Pig key whilst using the wheel, intensities will be increased or decreased in proportion to their individual level. For example, if fixture 1 is at 10%, 2 at 50% and the wheel is increased by 10%, then fixture 1 will move to 11% and 2 will move to 55%.

On the Hog 4 Console and Hog 4 PC only: The Nudge Up and Nudge Down keys can be used to increase and decrease the intensity by a preset amount. The size of the increment is 10% by default, but you can change it in the Programming pane of the User Preferences window.

Using Pig + Nudge Up and Pig + Nudge Down will create a half nudge step. It will increase or decrease the intensity by half of the assigned amount. For instance if the nudge value is set to +10% a Pig + Nudge Up will produce +5%.

Remainder Dim

The Rem Dim button on the Main Toolbar sets the intensity of any unselected fixtures in the current editor to 0%. The Rem Dim button is disabled by default in new shows. To enable the Rem Dim button open the preferences window and turn off the "Disable Rem Dim Button" located under the programming tab.

6.3.2 Position

Using the Trackball

To switch the Trackball from controlling the cursor to controlling fixture position, press the top right selection key adjacent to the Trackball. When controlling fixture position the Trackball will glow blue, and can be used in two modes. To change mode press the top right Trackball selection key.

- **Position Mode:** In the default mode, the pan and tilt of the fixture follows the movement of the Trackball.
- **Ortho Mode:** Ortho mode helps the accurate positioning of fixtures by constraining pan while changing tilt, or vice versa.

The Status Bar at the right hand end of the Command Line Toolbar shows when the Trackball is in Position Mode with the legend 'POS', and when it is in Ortho Mode with the legend 'Ortho'.

You can assign the way that fixtures move in relation to the Trackball. See *Swap Axes* (p.140).



Tip

An external mouse will always control the graphical pointer, so you can keep the Trackball in position mode to save having to change modes as you program.

Using the Parameter Wheels

The pan and tilt parameters also appear on the parameter wheels after the Position key is depressed, and can be used as an alternative to the Trackball.

Flip

With some moving lights, there is more than one combination of pan and tilt that results in the beam hitting the same point on the stage. You may sometimes want to change the pan and tilt combination being used, for example to ensure that the fixture takes the most direct route during a position change.

The Flip function cycles the selected fixtures through the possible combinations in turn. To do this, select the fixture or fixtures and press Flip on the Main Toolbar.

Holding the Pig key down while pressing Flip cycles through the combinations the other way.



Tip

When the Trackball is in position mode, the top left Trackball key also acts as a Flip key, for quick access while positioning fixtures.

6.3.3 Continuous Parameters: Colour and Beam

Colour and beam parameters can be either discrete (known as ‘slotted’) or continuous. An example of a slotted parameter is the gobo and colour wheels in a moving light, which can be assigned to values such as Gobo 1 and Colour 3. Examples of continuous parameters are the colour mixing controls on some moving lights, irises, and variable-speed strobes; these can be assigned to a percentage or real-world value. It is sometimes useful to treat slotted parameters as continuous; for example, you might want to assign a gobo or colour wheel part way between two positions to achieve a particular effect. Hog 4 OS allows you to treat such parameters as either slotted or continuous when assigning values to them.

To control continuous colour and beam parameters:

1. Press the appropriate parameter type key : Colour or Beam or any user kind key that contains colour and beam functions. The Wheels Toolbar shows the available parameters and their current value; see *Figure 6.6, “Wheels Toolbar for the Beam Parameters of a Studio Spot 575”*.
2. If the selected fixture has more parameters of the selected type than there are wheels, the Wheelsets Toolbar will open; see *Figure 6.7, “The Wheelsets Toolbar for a Studio Spot 575”*. Page through the available parameters by pressing the parameter type key again, or select a button on the toolbar.
3. Adjust the parameter value using the parameter wheels.

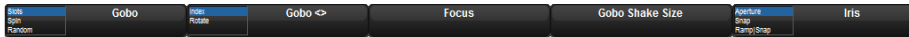

Figure 6.6. Wheels Toolbar for the Beam Parameters of a Studio Spot 575

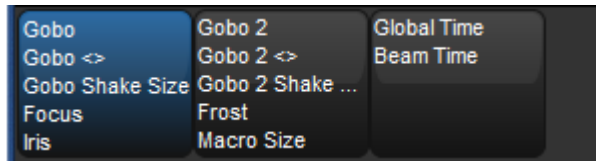

Figure 6.7. The Wheelsets Toolbar for a Studio Spot 575

Some parameters that appear on the parameter wheels have more than one mode. These modes are shown as a list on the Wheels Toolbar, and you can select the modes by clicking on the wheel's button on the toolbar.

Direct Value Entry

For parameters appearing on the parameter wheels, you can hold **Set**, then press the associated button on the Wheels Toolbar to open a direct value entry dialog; see *Figure 6.8, “The Wheels Toolbar Direct Entry Dialog”*

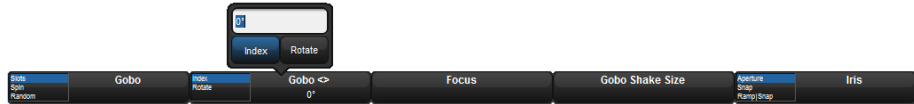

Figure 6.8. The Wheels Toolbar Direct Entry Dialog

Enter a value for the parameter in the direct value entry box and select any available modes. Press Enter to complete the direct value entry.

Snapping to a Single Value

When you have several fixtures selected, you can make all the values of a parameter the same as that of the first fixture:

- Press and hold the / key while turning the appropriate parameter wheel.

Jumping to Endstop Values

You can assign a parameter to its endstop values:

- Press and hold the + key and adjust the appropriate parameter wheel clockwise to assign the parameter to its maximum value, and anticlockwise to assign the parameter to its minimum value.

Inverting Parameter Values

Some parameters have values either side of zero; for example, gobo rotation speed. You can invert such parameters so that they have the same value but the other side of zero. In the case of gobo rotation, this reverses the direction whilst maintaining the current speed. To invert a parameter:

- Press and hold the – key and adjust the appropriate parameter wheel.

6.3.4 Slotted Parameters: Colour and Beam

To control slotted colour and beam parameters such as gobo and colour wheels:

1. Press the appropriate parameter type key : Colour or Beam. The Slot Toolbar shows the available parameters; see *Figure 6.9, “The Slot Toolbar for a Studio Spot 575”*.
2. Click on the required parameter, and an additional toolbar will open showing the available slot positions; see *Figure 6.10, “The Colour Slots Toolbar for a Studio Spot 575”*.
3. Select a slot from the available slot positions.



Figure 6.9. The Slot Toolbar for a Studio Spot 575

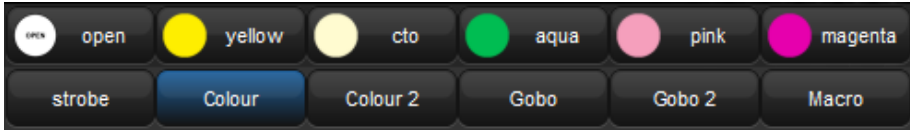

Figure 6.10. The Colour Slots Toolbar for a Studio Spot 575

6.3.5 Working with Colour

Fixtures that have continuously variable colour mixing create colour in different ways. The two main systems are:

- **CMY:** this system is used by most moving lights that have continuous colour mixing; the colour is controlled by three parameters: Cyan (C), Magenta (M) and Yellow (Y). Fixtures that use the CMY system start by producing white light, and then filter out the unwanted colours to leave the desired colour; higher parameter values produce a greater filtering effect, so that setting them all to 100% produces black. To avoid wasting the light intensity of the fixture, you should always keep at least one of the CMY parameters at 0%, setting the other two at higher values to get more saturated colours. For example, values of 0%C, 0%M, 20%Y will produce a pale yellow tint, while 0%C, 100%M, 0%Y will produce a fully saturated magenta. Mixing two of the colours will produce further shades, so 50%C, 0%M, 50%Y will produce a middle-saturation green.
- **RGB:** this system is used mainly by fixtures based on LEDs. The colour is controlled by three parameters: Red (R), Green (G) and Blue (B); with the three parameters at 0% the fixture produces no light output, and the higher than value of these parameters, the greater the fixture's total light output. If the three parameters have equal values, then the light output will be white (within the limits of the technologies used). Use one or two of the parameters to get the colour you want, and then add the other(s) to de-saturate it ('dilute' it towards white). For example, values of 0%R, 0%G, 100%B will produce a bright, saturated blue, while 80%R, 80%G, 100%B will produce a bright, blue tint. 50%R, 100%G, 100%B will produce a middle-saturation cyan.

While Hog 4 OS allows you to control the CMY or RGB parameters of fixtures directly, this method has several disadvantages:

- With both the RGB and CMY systems, it is difficult to remember what combination of settings will achieve the colour you want.
- With both systems, colour and fixture intensity are linked. Under the CMY system, giving all three parameters values above 0% unnecessarily reduces the light output; with the RGB system, fixtures often don't provide a separate intensity parameter so you have to control it with the colour parameters. However, it is usually much more convenient when programming to keep colour and intensity completely separate.

- The different colour systems, together with different lamp types used, make it difficult to match colours between fixtures of different types. Furthermore, during cross-fades colours tend not to remain matched through the duration of the cue, producing uneven colour fades.

Hog 4 OS solves these problems by using a third colour system: Hue and Saturation (HS). Under the HS system, a fixture's colour is determined by two parameters:

- **Hue:** the colour's position in the possible range of colours, from red, going through yellow, green, cyan, blue and magenta, and finally returning to red. As the range 'wraps around', you can visualise it as a circle with the colours positioned around the edge, with red at the top, green at the lower right, blue at the lower left, and the intermediate colours in between. The angle between 0 and 360 degrees specifies the hue of the colour: red has a hue of 0 degrees, yellow has a hue of 60 degrees, and cyan has a hue of 180 degrees. See *Figure 6.11, "The Colour Wheel"*.
- **Saturation:** how 'strong' or 'pale' the colour is. Pale colours have low saturations, while strong colours have high saturations. Saturation is specified as a percentage between 0% (white) and 100% (the strongest possible saturation).

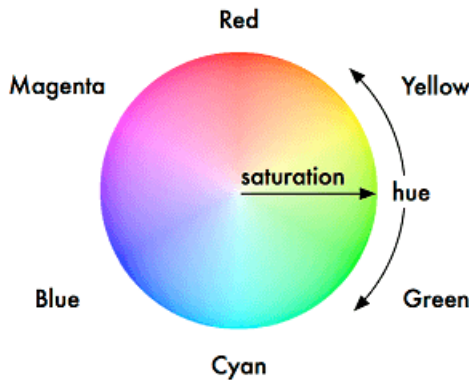

Figure 6.11. The Colour Wheel

When you program with the HS parameters, Hog 4 OS stores all values as HS, and converts them to CMY or RGB as required when sending DMX data to the fixtures. As part of this process, the console is able to match the colours of different fixture types; see *Using Colour Matching (p.164)*.

The Hue and Saturation parameters of fixtures with continuous colour mixing are controlled in the same way as other continuous parameters; see *Continuous Parameters: Colour and Beam (p.160)*. You can also use the Colour Picker and Gel Picker; see *The Colour Picker (p.164)* and *The Gel Picker (p.165)*.

Using Colour Matching

One of the advantages of the Hog 4 OS's HS colour system is its ability to match colours across different fixture types. Assigning the Hue and Saturation parameters of two different types of fixtures will set them to the same visual colour (within the limitations of the fixtures), but it might send different DMX values to each. Furthermore, they will maintain that match through a cross-fade, ensuring even colour fades.

For colour matching to work, the fixtures need to have a colour calibration in the fixture library; you can check this in the Fixture window:

- Setup → Patch

If the fixture has Yes in the Col Cal column, then it has a colour calibration. Fixtures that are not calibrated will use a standard DMX mapping to determine hue and saturation.

The Colour Picker

You can use the Colour Picker to graphically select Hue and Saturation values. To open the Colour Picker:

- Hold down the Open key and select HS Picker.

Or:

- Pig + Open + Colour

There is also a button to open the Colour Picker in the Colour Directory window.

The Colour Picker will change its display according to the fixture selection:

- With no fixtures selected, you just see the colour wheel with saturated colours around the outside, and paler colours towards the centre.
- When a calibrated fixture is selected, a dashed line will be superimposed on the colour wheel. This line represents the fixture's gamut, or range of colours that it can achieve. To select any colour within this range, simply click on it. The new selection will be marked by a superimposed cross and circle. If you select a colour outside the fixture's gamut, one marker ('X') indicates the colour that was chosen, while a second ('O') indicates the closest colour that the fixture can produce. The two markers are joined by a line to indicate they are related.
- Fixtures that do not have colour mixing capabilities do not appear in the Colour Picker.
- If you have several different fixture types selected, the lines on the colour picker change to display the range of colours that all of the selected fixtures can achieve (shown as a dotted line), as well as the range of colours that at least one of the fixtures can achieve (shown as a dashed line). When you select a colour, a single target marker ('X') is displayed, connected to a series of 'O' markers, one for each fixture type.



Figure 6.12. The Colour Picker

- The Colour Picker also displays the gamuts and markers for fixtures that are currently in the editor, but not selected. These are shown in grey.
- Fixtures that are not color calibrated use a standard HS method and the Colour Picker will appear without any dashed lines.

The Gel Picker

You can use the Gel Picker to select colours matched to traditional gels. Clicking on a button in the Gel Picker sets the Hue and Saturation parameters of the selected fixtures to values that match the selected colour as closely as possible.

You can select colours from the Lee, Rosco E-Colour, Rosco Supergel and GamColor ranges, using the buttons in the toolbar at the top of the window. You can also select whether to match to the gel as it would appear in a Par 64 or similar conventional tungsten source, or in a Source 4, which has a slightly bluer light output.

There is a button to open the Gel Picker in the Colour Directory window.



Figure 6.13. The Gel Picker

Note that the Gel Picker colours are not palettes, and will not be embedded in programming; they are simply shortcuts to the appropriate HS values. Gel Picker colours are a closer match when applied to colour calibrated fixtures than non calibrated ones.

6.3.6 Fine Control

Holding the Pig key and moving the encoder wheel allows fine adjustment of the currently selected parameter, so that each turn of the wheel will change the parameter value by a smaller amount. This is useful for making exact adjustments to values.

6.3.7 Touching Parameters

When you start to record your programming as cues you will find that only the parameters that you have assigned values to are stored; these are known as 'Hard Values'. This is important because in cuelists values track through until they are changed, and this allows different playbacks to interact to create a single onstage look. For a complete explanation of tracking, see *Tracking* (p.29).

However you will sometimes want to ensure that a value is stored at its current value in a cue or palette. To do this you can Touch it:

- To touch all parameters of the current selection simply press the Touch key on the Main Toolbar.
- To touch only the parameters of a particular kind, press the appropriate parameter type key followed by Touch. For example:

- Position Touch : touches all position parameters of the selected fixtures.
- To touch a single parameter you can hold the Touch button while moving that parameter's wheel slightly. The current value will be touched without modification from the parameter wheel.

Untouched values appear in the editor with a white background. Once you have touched parameter values they are available for recording in the same way as any value that you have assigned. They are shown with a blue background, indicating that they have been modified:

Num ▲	Intensity	Strobe Type	Position Pan	Tilt	Colour Mix Cyan
Studio Color 575					
1			46°	53°	

Num ▲	Intensity	Strobe Type	Position Pan	Tilt	Colour Mix Cyan
Studio Color 575					
1			46°	53°	

Using Pig + Touch

You can bring parameter values into an editor without touching them using Pig + Touch. As the parameters haven't been touched, they won't be recorded as part of the contents of the editor. This can be useful if you want to have the parameter values in the editor in order to copy them to other fixtures.

For example, to copy parameter values from fixtures 1-5 that are on stage to fixtures 6-10 in the current editor:

1. 1 Thru 5 Pig + Touch : select the fixtures 1-5, and bring their onstage values into the editor without touching them:

Num ▲	Intensity	Strobe Type	Position Pan	Tilt	Colour Mixing				
					Cyan	Maqenta	Yellow	Hue	Saturatio
Studio Color 575									
1	100%	open	46°	53°	~	~	~	151°	88%
2	100%	open	0°	0°	0%	0%	0%	~	~
3	100%	open	0°	0°	0%	0%	0%	~	~
4	100%	open	0°	0°	0%	0%	0%	~	~
5	100%	open	0°	0°	0%	0%	0%	~	~

2. Copy 6 Thru 10, Enter : copy the parameter values to fixtures 6-10:

Num ▲	Intensity	Strobe Type	Position		Colour Mixing					
			Pan	Tilt	Cyan	Magenta	Yellow	Hue	Saturatio	
Studio Color 575										
1	100%	open	46°	53°	~	~	~	151°	88%	
2	100%	open	0°	0°	0%	0%	0%	~	~	
3	100%	open	0°	0°	0%	0%	0%	~	~	
4	100%	open	0°	0°	0%	0%	0%	~	~	
5	100%	open	0°	0°	0%	0%	0%	~	~	
6	100%	open	46°	53°	~	~	~	151°	88%	
7	100%	open	0°	0°	0%	0%	0%			
8	100%	open	0°	0°	0%	0%	0%			
9	100%	open	0°	0°	0%	0%	0%			
10	100%	open	0°	0°	0%	0%	0%			

- Record : the contents of the editor is recorded with only fixtures 6-10, not 1-5.

If the above example had used Touch instead of Pig + Touch, then you would have to untouch or knockout 1-5 before recording.



Tip

Values with a dark or light blue background in the Programmer or editor are recordable, while those with a white or gray background are not recordable.

6.3.8 Copying Parameter Settings

You can copy the parameter values of one fixture to another.



Important

If you copy parameter settings between fixtures of different types, only those parameters that the fixtures have in common will be copied.

Using the Command Line

To copy from the current selection:

- Copy 8 Enter : copies the parameters of the current selection to fixture 8.

To copy from specified fixtures:

- Fixture 1 Thru 4 Copy 8 Thru 11, Enter : copies the parameter settings of Fixtures 1-4 to 8-11.

To copy parameter values from the fixtures of one group to the fixtures of another group within an editor:

- Group 1 Copy Fixture Group 2 Enter : copies the parameter values of the fixtures in group 1 to the fixtures in group 2.

You can add parameter, location and destination masks to any copy command:

- **1 Thru 4 Intensity Copy List 3 Cue 1 Fixture 8 Thru 11, Enter** : copies the intensities of fixtures 1 to 4 in the current selection to fixtures 8 to 11 in cue 1 of cuelist 3.

You can use Copy to reverse the order of values. For example, if fixture 1 is at 10%, fixture 2 at 20%, and fixture 3 is at 30%:

- **1 Thru 3 Copy 3 Thru 1 Enter** : the fixtures will now be at 30%, 20% and 10% respectively.



Tip

When you press the Copy key, the words 'Copy to' appear on the command line. This is a useful reminder of the syntax of the copy command.

In the Programmer or Editor Window

You can copy fixture data by using the Copy and Paste commands: click the right-hand mouse or Trackball button on the desired cell(s) in the editor window and select Copy or Paste from the menu.

You can also use the Pig key to copy and paste selected cells:

- Pig + Copy : copy
- Pig + Record : paste

Copy Options

By default, when you copy parameter values from one fixture to another, the console will copy exactly the data from one fixture to another, including any palette references. You can optionally have the hard values from within the referenced palette copied to the destination instead of the palette references:

1. Fixture **1** : select the fixture you want to copy.
2. Copy
3. Deselect the Allow Refs button on the copy toolbar.
4. **8** : select the fixture to copy to.
5. Enter : copies the parameters of Fixture 1 to Fixture 8, converting any palette references to hard values.



Tip

You can copy a fixture to itself with Allow Refs deselected to convert palette references to hard values.

6.3.9 Restoring Default Values

You can reset parameter values to their default settings by using the . (point) key or PiG + . keys as a modifier. Default values for parameters can be set in the Edit Fixtures window.

When using the . key as a modifier, modes such as gobo rotate will be restored to default value but the current mode will remain (gobo rotate). When using the PiG + . keys as a modifier, modes such as gobo rotate will be restored to default value and default mode (index).

To restore the default value for a single parameter of the current selection:

- Press and hold the . key or PiG + . keys and turn the appropriate parameter wheel.

To restore the default values of a parameter kind for the current selection:

- Press and hold the . key or PiG + . keys and press the appropriate kind key.

To restore the default values for all parameters of the current selection:

- Press and hold the . key or PiG + . keys and press the Fixture key.

6.4 Fanning

Fanning allows you to assign a parameter across several fixtures, so that the parameter values are equally spaced. For example, if you have five fixtures all at 50% intensity, you can use fanning easily to assign intensities of 30, 40, 50, 60 and 70% across five fixtures. Note that in this example, the middle value of the five stays the same, and the end values change the most, while the other values change proportionally.

You can fan any values including parameters and timings. For example, you can use fanning with position: suppose that you have seven moving lights on an upstage position, all pointing downstage towards the audience. You could fan the Pan parameters so that the centre fixture still points downstage, and the others turn progressively out to stage left and right.

The fixture selection order is significant when fanning; see *Selection Order* (p.156). The value change when fanning is always relative to its current value; if there is no current value the parameter will fan from its default value.



Tip

Choosing the initial, or 'base', value is important when fanning, as the parameter values cannot go below 0% or above 100%. Make sure that you leave enough of the value range for the value to fan into.

6.4.1 Using the Fan Key

To fan a parameter:

1. **1 Thru 5 @ 30, Enter** : select the fixtures and assign the intensities to 30%:

Num ▲	Intensity	Strobe	Position	
		Type	Pan	Tilt
Studio Color 575				
1	30%			
2	30%			
3	30%			
4	30%			
5	30%			

2. Press and hold the Fan key, whilst slowly moving the I-Wheel. The fixtures at either end of the range take the values 10% and 50%, with those in between evenly spread across the intervening range:

Num ▲	Intensity	Strobe	Position	
		Type	Pan	Tilt
Studio Color 575				
1	10%	open		
2	20%	open		
3	30%	open		
4	40%	open		
5	50%	open		

6.4.2 In the Programmer Window

To fan a parameter:

1. Select a range of cells, for example the intensity cells of Studio Colors 1 to 5.
2. **Set 10 Thru 50, Enter** : The fixtures at either end of the range take the values 10% and 50%, with those in between evenly spread across the intervening range.

You can also fan backwards; continuing the above example:

- **Set 50 Thru 10, Enter** : Studio Color 1 has an intensity of 50% and Studio Color 5 an intensity of 10%.

You can also fan several columns at once, fanning both Pan and Tilt for example.

6.4.3 With the Command Line

To fan intensities from the command line:

- **1 Thru 5 @ 10 Thru 50, Enter :** The fixtures at either end of the range take the values 10% and 50%, with those in between evenly spread across the intervening range.

You can also fan backwards:

- **1 Thru 5 @ 5 Thru 10, Enter :** fixture 1 has an intensity of 50% and fixture 5 an intensity of 10%.

6.4.4 Fanning Options

By default, fanning adjusts parameter values proportionally from the centre of the fixture selection. You can have fanning work in other ways:

- **Fan Normal:** As described above, the middle fixture remains unchanged, while the first and last fixtures' values change the most, in opposite directions. For example:

Before fanning:	30	30	30	30	30
After fanning:	10	20	30	40	50

- **Fan From Start:** The first fixture in the selection order remains unchanged, while the last one's value changes the most. For example:

Before fanning:	30	30	30	30	30
After fanning:	30	40	50	60	70

- **Fan From End:** The last fixture in the selection order remains unchanged, while the first one's value changes the most. For example:

Before fanning:	30	30	30	30	30
After fanning:	70	60	50	40	30

- **Fan To Centre:** the middle fixture remains unchanged, while the first and last fixtures' values change the most, in the same direction. For example:

Before fanning:	30	30	30	30	30
After fanning:	50	40	30	40	50

You can set the fanning mode from the Fanning Toolbar:

- Press and hold the Fan key to display the Fanning Toolbar; see *Figure 6.14, "The Fanning Toolbar"*.

All subsequent fans will follow the currently selected fanning mode, until the editor is cleared.



Figure 6.14. The Fanning Toolbar

6.4.5 Multi-part Fanning

With the command line, you can enter multi-part fanning:

- **1 Thru 9 @ 10 Thru 50 Thru 10** : The fixtures at either end of the range take the value of 10%, that in the middle 50%, and the others spread between:

10	20	30	40	50	40	30	20	10
----	----	----	----	----	----	----	----	----

You can fan in as many parts as you want, separating values with the Thru key. Note that multi-part fanning only works with the command line, not when editing values in the spreadsheet.

6.4.6 Fanning with Segments and Buddying

Segmenting and buddying allows you to control the way that parameters are fanned to make complex patterns. The Segments... button on the main toolbar reflects the current segment/buddying settings of the console. To change segment and buddying settings press the Segments... button on the Main Toolbar. A Segments and Buddying toolbar will then appear. Press Enter or click on the toolbar's Close button when you have made your selection.

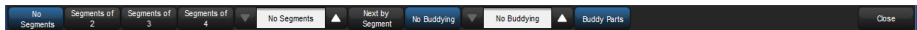

Figure 6.15. The Segments Toolbar

The segments toolbar displays the current segment and buddying size and has buttons to increase and decrease the segment size and the buddying. There are also shortcuts for common segment sizes and options for nexting by segment and buddying parts.

Note that segments and buddying are only used during fanning; segment and buddying information is not recorded into cues and palettes; only the resulting parameter values are recorded.

- **Segmenting:** Segmenting a fixture selection is achieved by setting a segment size on the segments toolbar (represented as "segments of x"). Fanning is repeated for each segment. For example, segmenting twelve fixtures into "segments of three" will result in the fan pattern shown in the figure below:



Num	Intensity
31	0%
32	50%
33	100%
34	0%
35	50%
36	100%
37	0%
38	50%
39	100%
40	0%
41	50%
42	100%

- Buddying:** The buddying number puts the fixtures into ‘gangs’ that all take the same value. For example, fanning a selection of twelve fixtures with a buddying value of three would result in fixtures 1 to 3 having the same parameter value, fixtures 4 to 6 having the same value, and so on:



Num	Intensity
31	0%
32	0%
33	0%
34	33%
35	33%
36	33%
37	67%
38	67%
39	67%
40	100%
41	100%
42	100%

- Buddy Parts:** When buddy parts is enabled the individual parts of compound fixtures and aggregated fixtures are treated as one fixture when fanning values. For example, when fanning intensity across a group of a compound fixtures such as LED bars composed of multiple cells, the standard fanning behavior results in a fanning between each cell. Enabling the buddy parts option buddies the cells of the LED bars so that they are treated as single fixture which produces fanning between each fixture and not each cell.



Tip

By default the segment and budding options are retained even after pressing the Clear key. To reset the segment and budding options when Clear is pressed, enable the option in Setup → Preferences → Programming.

6.5 Removing Values

As well as assigning values for parameters, you will sometimes want to remove parameter values from editors. For example:

- You no longer want to use a particular fixture in a cue, scene or palette.
- You decide to have the colour of several fixtures controlled by a different cuelist on another playback. To do this, you need to remove colour parameter values, so that they don't take over control of the colour parameters under the LTP rule. See *HTP and LTP* (p.30).



Tip

If you want to clear the entire contents of an editor, use the Clear key.

6.5.1 Removing Entire Fixtures from an Editor

To remove selected fixtures from an editor (known as 'knocking out'), press the Knockout button on the Main Toolbar. For example:

- Fixture 1 Thru 5 Knockout : removes Fixtures 1 to 5 from the editor.
- Group 2 Knockout : removes all fixtures in Group 2 from the editor.

6.5.2 Removing Kinds from an Editor

You can remove specific parameter types from the selected fixtures in an editor using fixed kinds or user kinds keys:

- Colour, Knockout : Select the parameter type and press Knockout

6.5.3 Removing Individual Parameters from an Editor

You can remove individual parameters from the selected fixtures in an editor:

- Hold Knockout and move the relevant parameter wheel, or press the relevant button on the Slot Toolbar.
- Hold Backspace and move the relevant parameter wheel.

- Hold Backspace and press the relevant parameter type key; this gives single-handed operation.
- You can remove the values from the currently highlighted cells in the Programmer by pressing Pig + Backspace.

6.6 Separating Parameters

When recording a cue, scene or palette, Hog 4 OS only records parameters that have been changed or touched since the last cue was recorded. See *Tracking* (p.29) and *Working with Tracking* (p.219).

However, some parameter types are treated as a single fixture ‘attribute’, so for example when you touch one of the three colour parameters of a colour mixing fixture (cyan, magenta or yellow), the other two are automatically touched at either their current value from playback, or at their default values.

For most purposes this provides the results that you would expect but there may be situations where you want to separate the linked parameters, for example to run separate chases with the cyan, magenta and yellow parameters.

By default, Hog 4 OS links all position parameters together, and all colour parameters together. You can separate linked parameter types in the kinds editor window for both fixed and user kinds:

1. Hold Open key and select the Kinds; button from the setup toolbar.
2. Toggle separating parameters on and off by pressing the parameter type buttons; see Figure 6.16, “A Kind Editor for the Colour kind with separate parameters turned on.”.

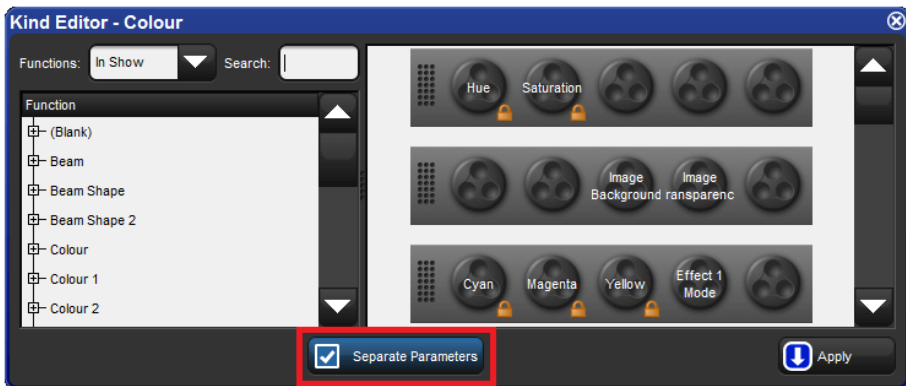

Figure 6.16. A Kind Editor for the Colour kind with separate parameters turned on.

Section 7: Groups

7.1 Auto-Generating Groups

The quickest and easiest way to create groups is via the auto-palettes button in the fixture window. Several group options exist when auto-paletting including how many different group combinations for each fixture type you want to generate (maximum group repeat) and whether you would like to generate groups based on notes written in the patch window (make group notes).

When the "Make Note Groups" option is turned on a set of groups (in addition to the normally generated groups) will be created based on the fixture notes written in the notes column of the fixture window. For example, if you add a "downstage wash" note to Solaspots 1<5, then a auto-generating groups with the note option turned on will result in a "downstage wash" group being created that contains Solaspots 1<5. See *Creating Palettes and Groups Automatically* (p.136) for more details on this feature.

7.2 Recording Groups

When recording a group, only the active fixture selection is recorded, not all the fixtures currently in the editor. To record a group:

1. Select the desired fixtures in the Programmer or editor.
2. Record, Group : the Group Directory window opens.
3. Select the destination location in the Group Directory window.
4. Alternatively, enter a number on the keypad and press Enter.
5. If the destination location is already used, you will be asked to choose an option: *Insert, Merge and Replace* (p.180).

When you record a group the selection order is also saved. This controls how fanning and effects are applied to the fixtures in the group, and is significant when using the Next and Back buttons; see *Selection Order* (p.156), *Fanning* (p.170) and *Effects* (p.257).



Tip

Hog 4 OS can automatically generate a useful set of groups based on the fixtures in your show: see *Creating Palettes and Groups Automatically* (p. 136).

7.3 Naming Groups

You can give a group a name that will be displayed in the Group Directory window:

1. Open + Group : opens the Group Directory window.
2. Select the group to be named.
3. Set [**name**] Enter : type in the name.



Tip

You can name a group, cue, scene or palette immediately after recording it by pressing the Set key. The Quickname window will open, and you can enter the name and select OK.

7.4 Using Groups in Programming

You use groups in the same way that you would use fixture selections, for example:

- Group **1**, Enter : selects all the fixtures in Group 1.
- Group **1 @ 50**, Enter : selects all the fixtures in Group 1 and sets their intensity to 50%.
- Group **1 + Fixture 3 @ 50**, Enter : you can mix fixture and group selections.

One particularly useful syntax to use with groups is the / key:

- Group **1 / Group 3** : selects only fixtures that are in both groups.

7.5 Editing Group Contents

To edit a group's contents, select the group within the Programmer or editor, make changes to the selection and re-record the group. Hog 4 OS will ask you to choose from *Insert, Merge and Replace (p.180)*. Select Replace to update the group with the new selection.

7.5.1 Removing Fixtures from Groups

You can remove the fixtures that are currently selected in the Programmer or editor from a previously recorded group. If you have a fixture selected in the Programmer or editor that is not in the group, that fixture is ignored.

For example, if you have a group containing fixtures 1-5, and you want to remove Fixture 2:

1. Fixture **2**, Enter : select the fixture you want to remove.
2. Record, Remove : the Remove button is on the Record Options Toolbar at the bottom of the right-hand screen.
3. Group **5**, Enter : removes Fixture 2 from Group 5.

7.6 Deleting Groups

To delete a group:

1. Group **1** Delete : deletes group 1.
2. Click OK to confirm the delete.

Or from the group directory:

1. Press and hold Delete whilst selecting the group to be deleted from directory.
2. Release the Delete key. A dialog will appear asking you to confirm the delete.
3. Click OK.

You can also delete several groups at once:

1. Group **1** Thru **5** Delete : deletes groups 1 through 5.
2. Click OK to confirm the delete.

Or from the group directory:

1. Press and hold Delete whilst selecting all the groups to be deleted from directory.
2. Release the Delete key. A dialog will appear asking you to confirm the delete.
3. Click OK.



Tip

If you prefer not to be asked to confirm the delete action, select Don't Ask Me Again in the confirmation window. You can reenable the confirmation by going to Setup → Preferences → Programming and selecting Confirm before deleting directory items.

7.7 Copying and Moving Groups

To make a copy of a group:

- Group 1 Copy Group 2 Enter : copies the contents of Group 1 to Group 2.

Similarly, to move a group to a new location:

- Group 1 Move Group 2 Enter : moves Group 1 to Group 2.

If the destination group already exists, you will be asked to choose an option: *Insert, Merge and Replace* (p.180).

To copy parameter values from the fixtures of one group to the fixtures of another group within an editor:

- Group 1 Copy Fixture Group 2 Enter : copies the parameter values of the fixtures in group 1 to the fixtures in group 2.

Similarly with masking options:

- Group 1 Intensity Copy Fixture Group 2 Enter : copies the intensity values of the fixtures in group 1 to the fixtures in group 2.

7.8 Insert, Merge and Replace

When recording or copying a group, if the destination location already has a group recorded in it, you will be prompted with record options of Insert, Merge or Replace.

If you are moving a group, only the Insert option is available.

- **Insert:** creates a new destination group. The new group will be assigned a free location just before the one chosen, using a point number if necessary.
- **Merge:** Incorporates the new information into the destination group.
- **Replace:** Overwrites the group information in that destination.



Tip

If you know that you are about to record, copy or move a group to an existing destination, you can pre-select Insert, Merge or Replace from the Record Options Toolbar. This appears after you press the Record, Copy or Move keys.

Section 8: Palettes

8.1 Recording a Palette

There are five palette directories (intensity, position, colour, beam, effects) into which users can record preset values for easy recall during show programming. The Hog 4 OS determines which function values are recorded into palettes based the kind masking specified at the time of recording. If the kind mask is empty (no kinds selected) at the time of recording then the palette directory's kind mask settings will determine which function values are recorded into the palette.

By default, Hog 4 OS records the appropriate parameter values of all fixtures in the Programmer or editor, not just those of the selected fixtures. To only record from selected fixtures, see *Recording Only Selected Fixtures* (p.189).

To record, for example, a position palette:

1. In the Programmer or editor, assign the position parameters of the desired fixtures as you want them in the palette.
2. Record Position : the Position Directory opens.
3. (Palette 2) : choose a location in the directory.

Or, using the command line:

- Record Position 2 Enter

If you leave out the palette location:

- Record Position, Enter

the palette will be recorded in the next available location.

If the destination palette already exists, you will be asked to choose an option: *Insert, Merge and Replace* (p.191).

8.1.1 Naming a Palette

You can give a palette a name that will be displayed in the Palette Directory:

1. Open + Position : opens the Position Directory.
2. Check that the Guard button is selected, so that you don't accidentally activate a palette when pressing its button in the directory.
3. Select the palette to be named by pressing its button in the directory.
4. Set [name] Enter : type in the name.



Tip
To name a palette immediately after recording it, pressing the Set key will open a Quickname window. Enter the palette name and select OK.

8.2 Using Palettes in Programming

In the Programmer or editor, you can apply a palette by selecting it from its directory window. The palette will be applied to the current fixture selection, as long as the palette contains parameter information for the selected fixtures. Doing so assigns the parameter value to be a reference to the palette. A palette that puts all Studio Colors in the rig to deep red will therefore apply this immediately to any Studio Colors that are in the current selection; see *Figure 8.1, "Example of Parameters set to reference a Palette"*.

For example:

1. Open + Colour : open the Colour Directory window.
2. **3 Thru 5** : select the fixtures.
3. (**Colour 2**) : select the palette from the Colour Directory window.

Or, using the command line:

- **3 Thru 5 Colour 2 Enter**

Num ▲	Intensity	Strobe Type	Position		Colour Mixing				Colour 1 Colour	
			Pan	Tilt	Cyan	Magenta	Yellow	Hue		Saturatio
Studio Color 575										
3	100%								Colour 2	Colour 2
4	100%								Colour 2	Colour 2
5	100%								Colour 2	Colour 2

Figure 8.1. Example of Parameters set to reference a Palette

8.3 Editing Palette Contents

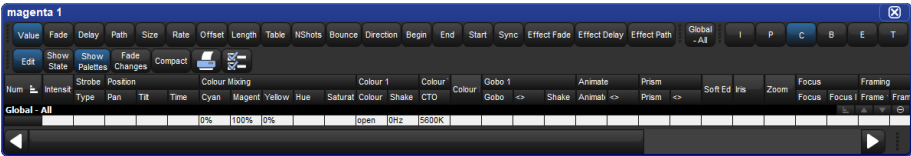

Figure 8.2. The Palette Editor window

You can change the parameter values that are applied when a palette is referenced during playback by editing the palette's contents in an editor window, see *Figure 8.2, "The Palette Editor window"*. For example, to open Colour Palette 2 for editing:

1. Open + Colour : opens the Colour Directory.
2. Open + (Colour 2) : opens the palette editor for Colour Palette 2.
3. Alternatively using the command line : Colour 2 Open
4. Press the Edit button in the editor window to select this as your current editor.

Within the editor, you can assign fixture parameters and timing in the same way as in the Programmer; see *Individual Parameter Timings (p.243)*. Press Update after editing to save the changes to the palette. For more information on working with editors, see *Editors (p.43)*.



Tip

When you open a palette for editing, you may only appear to see one fixture when you recorded several. This is due to the way palettes can be 'global', with a single set of parameter values that can be applied to any fixture; see *Global, Per Fixture Type, and Per Fixture (p.185)*.

8.3.1 Updating Palettes with Different Parameter Types

Palettes contain one or more parameter types. If you edit a palette and add values for parameters of a type that was not previously in the palette, and then update the palette, these values will not be stored. If you want to change the parameter types that a palette contains, you need to select the type from the Palette Masking Toolbar:

The Palette Masking toolbar



For example, suppose that you wanted to add a gobo (a beam parameter) to the existing Colour Palette 2:

1. Open + Colour : opens the Colour Directory.
2. Open + (Colour 2) : opens the palette editor for Colour Palette 2.
3. Press the Edit button in the editor window to select this as your current editor.
4. Select the B (Beam) button on the Palette Masking Toolbar.
5. Edit the fixture parameter values to assign the required gobo.

6. Press Update to save the changes.

**Tip**

You can also use the Palette Masking Toolbar to quickly remove all values of a particular parameter type from a palette by deselecting the appropriate button before updating.

8.4 Deleting Palettes

**Important**

Deleting a palette will remove all references to the palette that have been recorded in cues, scenes and other palettes, and replace the references with numerical parameter values. Creating a new palette in the same location will *not* replace the references, which are removed once the palette is deleted.

To delete a palette using the command line:

1. Colour 1 Delete : deletes Colour Palette 1.
2. Click OK to confirm the delete.

Or, from the palette directory:

1. Press and hold Delete whilst selecting the palette to be deleted from directory.
2. Release the Delete key. A dialog will appear asking you to confirm the delete.
3. Click OK.

**Tip**

If you prefer not to be asked to confirm the delete action, select Don't Ask Me Again in the confirmation window. You can re-enable the confirmation by going to Setup → Preferences → Programming and selecting Confirm before deleting directory items.

8.5 Copying and Moving Palettes

To make a copy of a palette in a new location:

1. Open + Colour : open the Colour directory.

2. Make sure that the Guard button is pressed, so that you do not accidentally apply palettes when trying to select them.
3. Select the palette that you want to copy by pressing its button in the directory.
4. Press the Copy key.
5. Press the button of the location in the directory you want to copy the palette to.

Or, using the command line:

- Colour 2 Copy Colour 3 Enter : copies the contents of Colour Palette 2 to Colour Palette 3.
- Group 5 Colour 2 Copy Colour 3 Enter : copies fixtures that are in Colour Palette 2 and Group 5 into Colour Palette 3.

Similarly, to move a palette to a new location:

- Colour 2 Move Colour 3 Enter : moves the contents of Colour Palette 2 to Colour Palette 3, leaving 2 empty.

If the destination palette already exists, you will be asked to choose an option: *Insert, Merge and Replace* (p.191).



Tip

References to palettes refer to the palette, not its location in the directory. If you move a palette from location 3 to location 4, references to the palette still refer to it in its new location, not to another palette you put in location 3.

8.6 Record Options

8.6.1 Global, Per Fixture Type, and Per Fixture

When you record a palette, parameter values can be recorded as global, per fixture type, or per fixture. The three kinds work in different ways when you apply the palette to fixtures during programming:

- **Global:** the palette's parameter values are applied to all selected fixtures that have that parameter. For example, a colour palette containing hue and saturation parameters is applied to all selected fixtures that have hue and saturation.

- **Per Fixture Type:** the palette's parameter values are applied to all fixtures of that type. For example, a palette containing parameter values for Studio Color 575s will only be applied to selected Studio Color 575s.
- **Per Fixture:** the palette's parameter values are applied only to those specific fixtures that are both in the palette and selected in the editor. For example, a palette containing parameter values for Studio Color 575 1 will only be applied to that fixture (and only then if it is selected).

By default, the following rules determine how the palette is recorded:

1. Position palettes are always recorded Per Fixture.
2. If all the fixtures to be recorded have exactly the same parameter values, then the palette is recorded as Global.
3. Otherwise the palette is recorded Per Fixture.

In the palette's editor, the parameter values in a Global palette will appear as All Types. Similarly, a palette with Per Fixture Type values will show them grouped by fixture type; see Figure 8.3, "A Palette with Global Parameter Values", Figure 8.4, "A Palette with Per Fixture Type Values" and Figure 8.5, "A Palette with Per Fixture Values". Make sure that you have aggregation turned on; see *Aggregation (p.40)*.

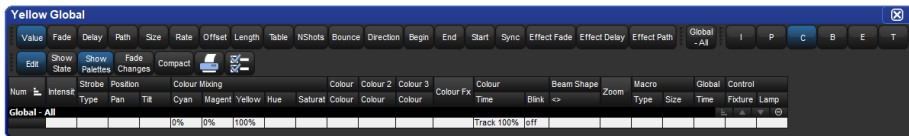

Figure 8.3. A Palette with Global Parameter Values

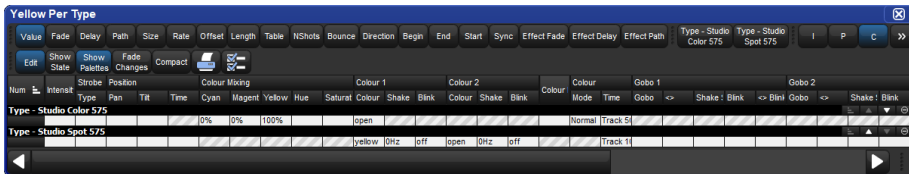

Figure 8.4. A Palette with Per Fixture Type Values

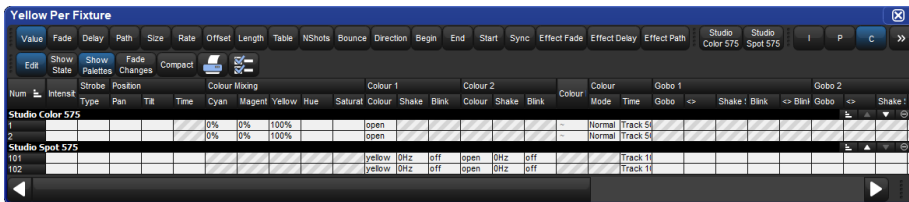

Figure 8.5. A Palette with Per Fixture Values

You can override the default settings using the Record Options Toolbar; for example to record a single fixture's parameter values as per fixture:

1. Assign the parameters of the fixture as required.
2. Press Record.
3. The Record Options Toolbar will appear on the bottom of the right-hand touch screen. Select Per Fixture.
4. Press the key to choose the palette type, for example Colour. The Palette Directory will open.
5. Select the palette location by pressing it in the Palette Directory window.

Similarly, to force a palette with one of each fixture type to be recorded as Per Fixture Type rather than the default Per Fixture, use the Per Fixture Type button on the Record Options Toolbar.

Forcing a palette to be Per Fixture Type can be useful if you want a palette that contains programming for more than one type of fixture, but that you can apply to any fixture of a type included in the palette. For example, you want to create a 'red' palette that can be applied to both Studio Colors and Studio Spots. If you select the first Studio Spot and make red then select the first Studio Color and make red (with different parameter values) and record this as palette, it will by default be by fixture and work only for those two fixtures. However if you select Per Fixture Type when recording, then the palette will work for *all* Studio Spots and *all* Studio Colors, assigning them the same values as was used to create the palette.

8.6.2 Recording Palettes with Kind Masking

The Hog 4 OS determines which function values are recorded into palettes based on the kind masking specified at the time of recording. If the kind mask is empty (no kinds are selected) then the directory's kind mask will determine which function values are recorded into the palette. In this section we will look at using kind masking as a method for filtering which function values are recorded into palettes.

The Palette Directory will display which fixed kinds are included in each palette, indicated by I for intensity, P for position, C for colour, B for beam, E for effect, T for time and L for control; see *Figure 8.6, "Example of Palettes containing different parameter types"*.

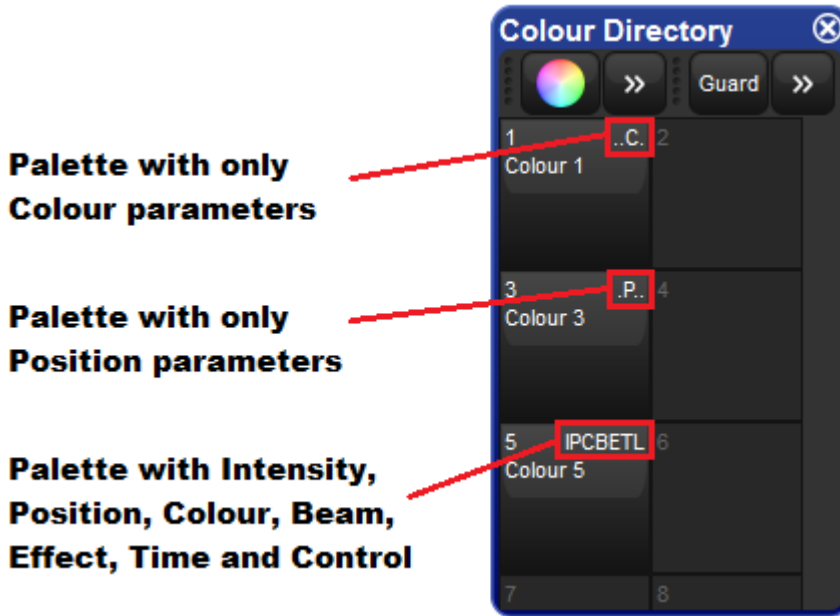

Figure 8.6. Example of Palettes containing different parameter types

Masking Using the Record Options Toolbar

To specify masking when recording a palette using the Record Options Toolbar:

1. Assign the parameters of the fixtures as required.
2. Press Record. The Kind Mask menu will automatically pop up above the record options toolbar and displays a grid of buttons containing all of the fixed kinds and user kinds included in your show. (See *Figure 8.7, "The Record Options Toolbar"*. (If kind masking menu does not automatically appear then check the "Automatically show kind masking toolbar" option in Programming pane of the user preferences window)
3. Deselect which kinds you do not want to include in the palette by toggling off the buttons.
4. Press one of the fixed kind keys to choose a palette type destination, for example Colour. The Palette Directory will open.
5. Select a palette location in the directory by pressing on any button in the Palette Directory window.



Figure 8.7. The Record Options Toolbar

Masking Using the Command Line

When recording a palette using the command line, you can choose which fixed kinds and/or user kind functions you want to start off with in the mask by listing them on the command line before the Record command:

- Colour Position Record Colour 3 Enter : records the colour and position parameters of the Programmer or editor contents into Colour Palette 3.

Recording Only Selected Fixtures

By default, all fixtures currently in the Programmer or editor are recorded. To record only selected fixtures:

1. Fixture 2 : select the fixture(s) you want to record in the palette.
2. Record
3. On the Record Options Toolbar press : Selected
4. Position, Enter : records only the position values for fixture 2 into the next available position palette, rather than values for all fixtures in the Programmer.

8.6.3 Palette Timing

To include timing when recording palettes ensure that the "Time" kind in the kind masking menu is selected after pressing record; see *Masking Using the Record Options Toolbar* (p.188).

You can also record palettes that contain only timing information (no function values) by only masking in "Time" when recording the palette. For example, to record a time only colour palette with a **fade time** of 6 seconds:

1. Assign any values to the fixture functions you want to create a timing palette for.
2. Assign a fade time to the fixture functions such as 6 seconds.
3. Time Record Colour 2 Enter : records only the timing information that was in the programmer into Colour Palette 2.

You can also edit timings in the palette's editor. See *Editing Palette Contents* (p.182).

8.6.4 Reference Palettes

When you record a cue using a palette, a reference to the palette is recorded instead of a numerical value for the parameters. Similarly, you can record palettes using other palettes, so that the new palette contains references rather than numerical values. A palette recorded in this way is known as a reference palette, and is marked in the palette directory window by this



Reference palettes are useful when you want to create palettes to use as simple 'building blocks' which you then make more complex building blocks from. For example, you might create a position palette that focuses some Studio Spot 575s onto the lead singer, and further position palettes that position other fixtures onto the remaining band members. You could then make an 'All Band' position palette with one fixture lighting each band member, in which each fixture references another palette, instead of having parameter values. If the drum riser was later moved, you could adjust the position palette that focused onto it, and the change would not only be updated in all scenes and cues programmed with that palette, but also all programming done with the 'All Band' palette.

By default, palettes are not recorded as reference palettes; any fixture parameters assigned using another palette is recorded as a numerical value. If you want to record a palette as a reference palette, select the Allow Refs record option:

1. Assign the parameters of the fixtures using other palettes as required.
2. Press Record.
3. The Record Options Toolbar will appear at the bottom of the right-hand touch screen. Press the Allow Refs button.
4. Press a key to choose the palette type, for example Colour. The Palette Directory will open.
5. Select the palette location by pressing it in the Palette Directory window.

8.6.5 Direct Palettes

Normally, when you use a palette to assign parameter values for recording in a cue or scene, a reference to the palette is inserted rather than numerical values. To insert numerical values instead of references, use direct palettes. Cues and scenes recorded using direct palettes will not update if the palette is later changed, because they contain ordinary parameter values rather than references to a palette.

You can use a palette as a direct palette on a one-off basis as you program, or you can assign it to always act as a direct palette; a direct palette is shown in the directory with

this



To temporarily use an existing palette as a direct palette when calling it into the Programmer or editor:

- **1 @ Colour 1** : the @ key indicates that the palette should be used in direct mode.

To create a direct palette:

1. Assign the fixtures as required.
2. Record
3. As Direct
4. (Position 2), Enter : choose a location for the palette.

To convert an existing palette to a direct palette:

1. Open + Colour : open the appropriate Palette Directory.
2. Set the directory window to spreadsheet view by pressing this button 
3. Select the Is Direct cell for the palette you want to change, and press Set to toggle the value to Yes.

Note that converting a palette to a direct palette will not alter any programming done previously using the palette; cues and scenes already recorded will still contain references to the palette. Only subsequent programming will be effected.

8.7 Insert, Merge and Replace

When recording or copying a palette, if the destination location already has a palette recorded in it, you will be prompted with record options of Insert, Merge or Replace.

If you are moving a palette, only the Insert option is available.

- **Insert:** creates a new destination palette. The new palette will be assigned a free location just before the one chosen, using a point number if necessary.
- **Merge:** incorporates the new information into the destination palette. If the same fixtures and parameters are in both palettes, the new values will replace the old.
- **Replace:** overwrites the palette information in that destination.



Tip

If you know that you are about to record, copy or move a palette to an existing destination, you can pre-select Insert, Merge or Replace from the Record Options Toolbar. This appears after you press the Record, Copy or Move keys.

Section 9: Directory Windows

9.1 Types of Directories

Directory windows are the windows that allow users to access recorded data such as palettes, cuellists, scenes, pages, effects, kinds, and groups using a grid of buttons. Directory windows and their contents can be displayed in a number of ways. The following sections in this chapter will cover the different options available for directory windows.

9.2 Mask (IPBCE Palette Directories Only)

The Palette Directories (IPCBE) mask settings determine which fixed function kinds are recorded into palettes for that directory if the command line kind mask is blank at the time of recording (no kinds selected). To change which kinds are included in the directory's mask open the configuration window for that directory, navigating to the mask tab, and enable/disable the individual function kinds in the menu.

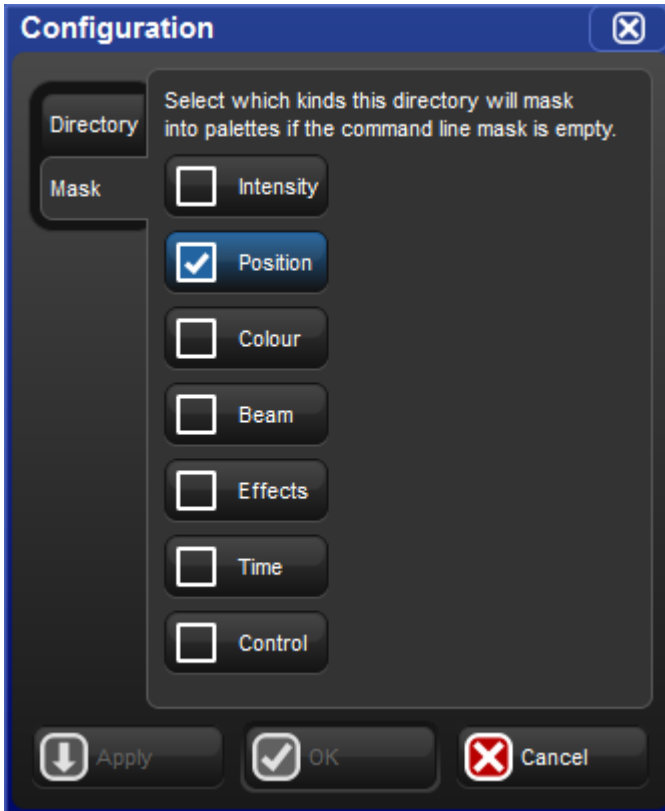

Figure 9.1. Directory Kind Mask Menu

A directory mask legend is shown at the top of each directory window and indicates which kinds will be recorded into palettes for that directory if the kind mask is blank at the time of recording.



Figure 9.2. Directory Kind Mask Legend

9.3 Color Coding

Each button within a directory window can be color coded to help distinguish it from the other buttons in the directory. To color code a directory button right click on the button in the directory window and choose from a preset palette of 12 colors, mix a

custom color, or choose to have the console auto-color code the button based on the dominant mixed color data recorded in the button (palette buttons only).



Figure 9.3. Right Click Color Coding Menu

9.3.1 Coloring the entire button

By default each directory window displays color coding using an outline around the directory buttons. If you prefer that the console color the entire background of the directory buttons click on



icon to open the window configuration menu and enable the "Color Code Entire Button" option. The option to color code the entire button is unique for each directory and is also stored when you record a directory window into a view.

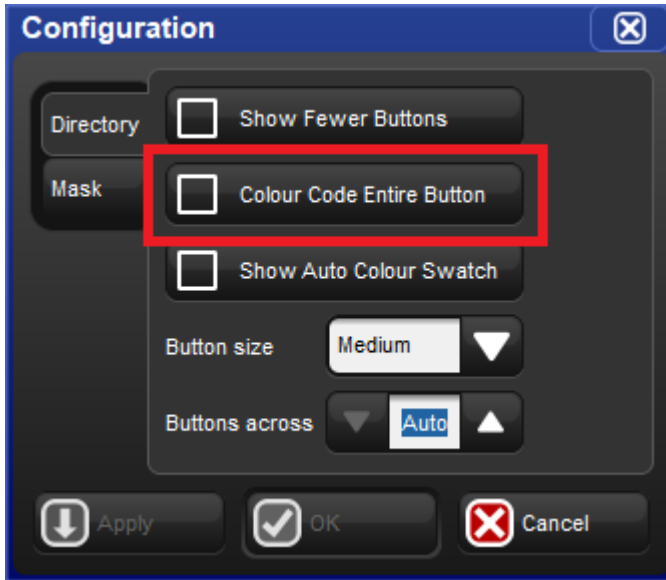

Figure 9.4. Color Coding Entire Button

9.4 Button Sizes

By default each directory window displays its buttons using a medium size. To change the displayed button sizes in any directory window open the window configuration menu by clicking on the



icon located at the top of the directory window. Locate the drop down menu option called "button sizes". Here you will see the option to display the directory's buttons in three different sizes: small, medium, and large. Set the button size menu option to the desired setting and press okay. The button size option you select for each directory is unique to that directory and is also stored when you record a directory window into a view.

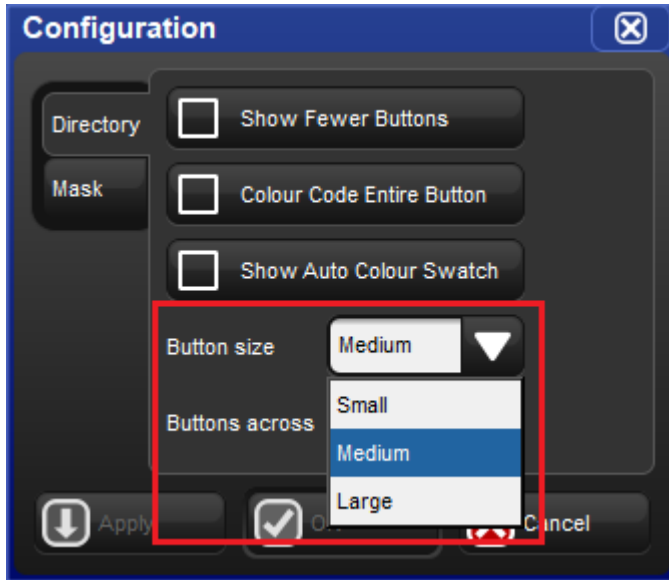

Figure 9.5. Button Sizes Option

9.5 Show Fewer Buttons

By default directory windows display both active buttons (buttons that contain data) and inactive buttons (buttons with no data). In some cases you may wish to hide the inactive buttons in the directory. To hide the inactive buttons in a directory click on



to open the window configuration menu and enable the "show fewer buttons" option. The option to show fewer buttons is unique to each directory and is also stored when you record a directory window into a view.

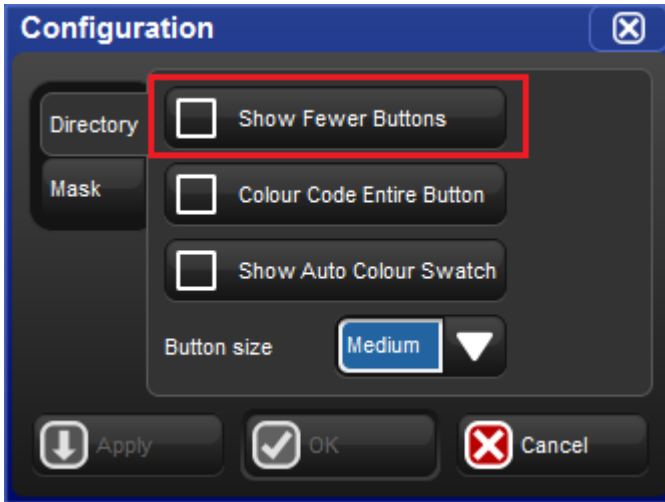

Figure 9.6. Show Fewer Buttons Option

9.6 Buttons Across Option

By default each directory window will display as many buttons across as can possibly fit into the dimensions of the directory window as it is sized on the screen. The buttons across option allows users to specify exactly many cells across the directory window should draw before starting a new row of buttons. This is handy for users who like to cycle directory windows through different sizes but would prefer the button layout remains the same. A horizontal scrollbar is displayed in cases where the “buttons across” value is greater than the number of buttons that the directory window can physically fit across the window due to its current size. For legacy Hog behavior use the “auto” option. To change the buttons across option for any directory window click on



icon to open the window configuration menu and adjust the buttons across value. The option to change the number of buttons across the directory window is unique to each directory and is also stored in views.

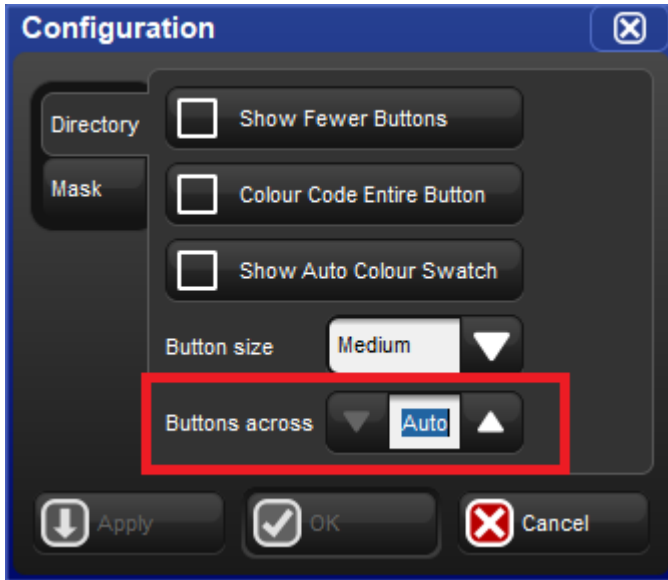

Figure 9.7. Buttons Across Option

9.7 Show Auto Color Swatch

The "show auto color swatch" option is available only in palette directory windows and is only useful in cases where the user has programmed color mixing values into a palette within that directory. When this option is turned on any buttons in the directory window that contain palettes with color mixing data will display a small color swatch in the middle of the button to indicate a dominant mixed color is recorded in that palette. To enable the "auto color swatch" option click on



icon and enable the "show auto color swatch" option. The option to show the auto color swatch is unique to each directory window and is also stored when you record a directory window into a view.

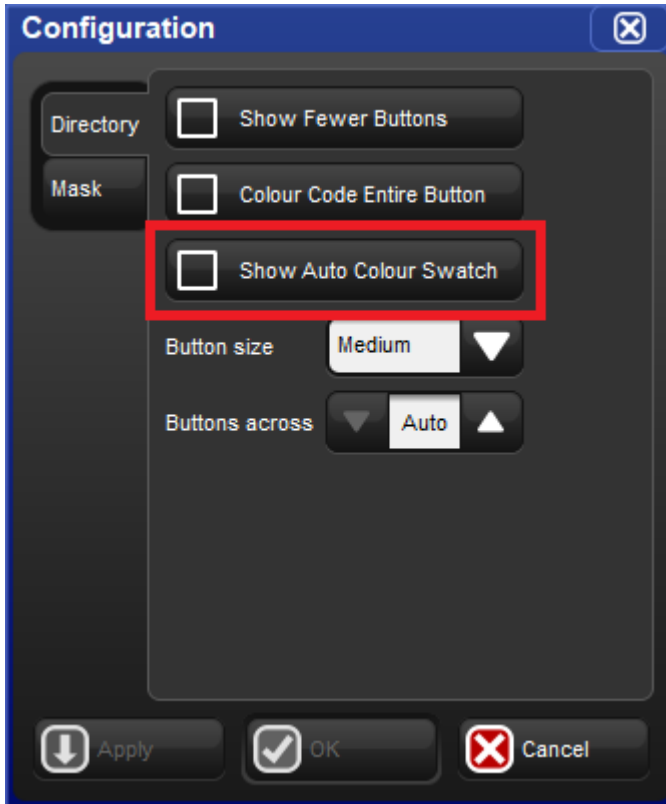

Figure 9.8. Auto Color Switch Option

9.8 Spreadsheet View

By default directory windows are displayed as a grid of touch-sized buttons, however you can also view the contents of any directory as a spreadsheet by clicking on



button. When in list view the directory buttons can be selected and/or applied by pressing on it's number in the num column. The option to display a directory in list view is unique to each directory and is also stored when you record a directory window into a view.



The Colour Directory shown in "Spreadsheet" view.

The Colour Directory shown in "Button" view.

Figure 9.9. Spreadsheet View vs. Button View of Colour Directory

Section 10: Media Picker

10.1 Media Picker Overview

The media picker is a tabbed, graphical window that allows users to view and select slotted function values for the current fixture selection using previews.

To open the media picker window hold the open key and press the “media picker” button on the main toolbar or press Pig + Open + Beam on the console front panel.

When a fixture selection is made the console will populate the media picker with previews as defined by the preview package assigned to that fixture. See section 10.6 for details on how preview packages are created and how to manage them.

In general, automated lighting fixtures will display previews for slotted functions such as strobe, gobo, color, and prism, while digital media servers such as the DL.HD will display previews for media files, 3-D objects, and masks. Preview selections made in the media picker window are applied to the current active editor.

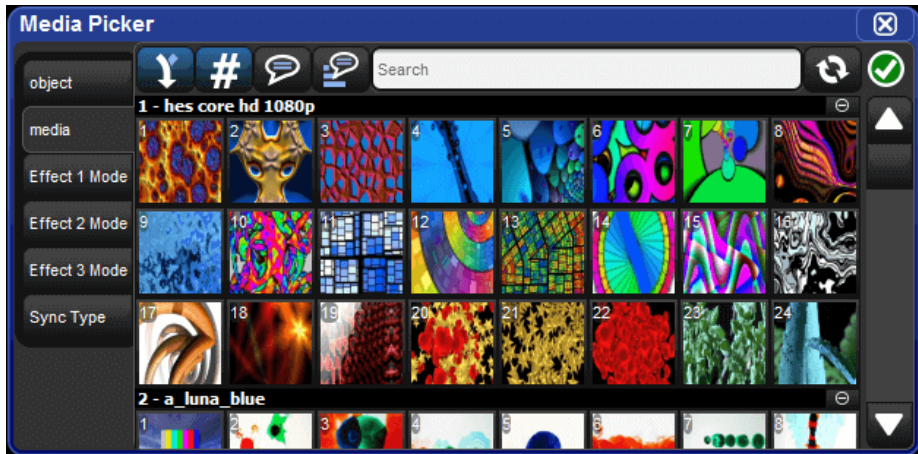
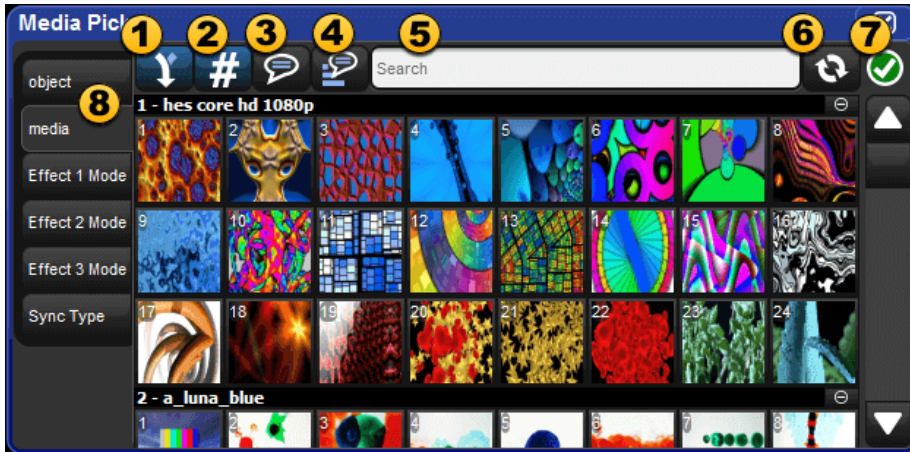

Figure 10.1. Media Picker Window

10.2 Media Picker Window Options

The media picker has several options for how previews are displayed in the window:



1. **Merged Different (default on)** : when this option is turned on the media picker window merges previews for content across the current fixture selection even if the preview images do not match. When in this mode a "page turn" icon will appear in the upper right corner for preview that is not the same across the entire fixture selection.
2. **Show/hide dmx value (default on)** : shows and hides the dmx value of the previews displayed in the media picker.
3. **Show/hide name** : shows and hides the preview names in the media picker.
4. **Reverse Display Order** : reversed the order in which the previews are displayed in the media picker.
5. **Search Filter** : input text to filter the contents of the media picker window.
6. **Preview Refresh Button** : click the refresh button to obtain the latest library defined media previews for the selected fixtures; most commonly used for refreshing media patched CITP fixtures.
7. **Package Status Icon** : icon indicating the health status of the preview package for the current fixture selection. Click on the icon for a detailed view of all running and completed preview package tasks.
8. **Function Tabs** : fixture functions such as gobo wheels, color wheels, media indexes, etc. are grouped into selectable tabs for easy navigation.

10.3 CITP Previews in the Media Picker

By default the media picker displays previews for fixtures using a default preview package for that fixture type as supplied by the fixture library. However, the media

picker can also display previews that have been downloaded and cached from connected CITP enabled fixtures. In this section we will review which CITP clients are supported by the Hog 4 OS for previewing, how to configure the DP8000 for CITP fixture discovery, how to associate fixtures to CITP media servers in the patch window, and finally how to use the patch window to refresh CITP media preview packages.

10.3.1 Supported CITP Media Server Clients

Hog 4 OS supports the following CITP Media server clients:

- **Arkaos MediaMaster** (*software versions 3.2.2, 4.2.1, 5.0.1, 5.2.2, 5.3.1*)
- **Coolux Pandoras Box** (*software version 4.7*)
- **Green Hippo Hippotizer** (*software versions 3.2.1, 3.2.2, 3.2.3, 3.2.4, 4.2, 4.3, 4.4*)
- **High End Systems Axon** (*software version 2.1.2 or greater*)
- **High End Systems DL.2** (*software version 2.1.2 or greater*)
- **High End Systems DL.3** (*software version 2.1.2 or greater*)
- **High End Systems DLV** (*software version 2.1.1 or greater*)
- **High End MMS-100** (*software version 2.1.1 or greater*)
- **PRG Mbox Studio & Mbox Mini** (*tested software versions 3.6.1, 3.8, 3.9, 3.10*)
- **D3 Technologies d3 Designer** (*software version 14 and 14.1 with Video Modules v15, v16*)

10.3.2 Configuring DP8000 for CITP Discovery

In order for the console to properly discover CITP enabled fixtures on a DP8000's FixtureNet network, the FixtureNet adapter for the DP8000 must be properly configured:

1. Open the node settings window for the DP8000 that is connected via FixtureNet to the CITP enable fixtures
2. Select the FixtureNet tab of the node settings window
3. Ensure that the IP address and subnet settings are appropriate for the network environment in which the CITP discovered fixtures are connected. This is similar to configuring the FixtureNet adapter for Art-Net and sACN output. To better ensure connectivity it is recommended that the IP address assigned to the FixtureNet adapter be within in the same sub-network as the CITP fixtures it is reeving preview thumbnails from.

10.3.3 Patching fixtures to CITP discovered fixtures

Once a fixture is scheduled into the patch window and patched to a DMX output, the fixture can then be patched to a CITP fixture that has been discovered on the FixtureNet network of any active DP8000 connected to the console. Follow these steps to patch a fixture to a CITP discovered fixture:

1. Open the patch window
2. Select the fixture(s) you wish to associate with a CITP fixture in the rig
3. Press the "patch media" button at the top of the patch window
4. Select the IP address of a discovered CITP fixture from the media patch window
5. Press okay. You will now see the IP address of the CITP fixture in the patch window listed for the fixtures you selected in step 2.
6. With the fixtures still selected press the "refresh media" button at the top of the patch window to fetch previews from the CITP fixture.



Caution

If the IP address of a discovered CITP fixture in the rig changes you will need to perform the "patch media" task again.



Tip

Selecting "None" from the list of CITP discovered fixtures in the media patch window will disassociate/unpatch the selected fixtures from CITP discovered fixtures and revert the fixture to using the default preview package supplied by the fixture library.

10.3.4 Refreshing CITP Previews

The content stored on CITP discovered fixtures may change during the programming of your show. For example, the video clip file used in the opening scene might have been changed on the media server. The console is not automatically made aware of these content changes and so it is necessary to request new previews from the fixture in order to update the cached preview package on the console. Follow these steps to update cached CITP previews on the console:

1. Select the fixture(s) you wish to refresh the media.
2. Open the fixture window or the media picker window.
3. Press the "refresh media" button at the top of the fixture window or press the refresh button at the top of the media picker window. A green and white animated refresh icon will appear at the top right of the media picker window to the right of the search field. The media refresh is finished when the status animation changes to a green check mark (this indicates a successful refresh) or yellow exclamation point (this

indicates there was an issue refreshing the media previews for the selected fixtures; click on the yellow exclamation point for details).

10.3.5 Disabling CITP on DP8000

By default CITP is enabled on all DP8000s in new shows. To disable CITP on a DP8000:

1. Open the node settings window for the DP8000
2. Select the CITP tab of the node settings window
3. Deselect the enable button and hit apply

10.4 Catalyst Previews in the Media Picker

In addition to CITP and fixture library defined preview packages, the Hog 4 OS is also capable of displaying previews for content stored on Catalyst media servers. In this section we will review how to configure D8000s for downloading Catalyst previews, how to associate Catalyst fixtures to Catalyst media servers in the patch window, and how to use the patch window to refresh cache Catalyst preview packages on the console.

10.4.1 Configuring DP8000 for Catalyst Previews

In order for the console to properly fetch and display thumbnail previews for Catalyst media servers on a DP8000's FixtureNet network, the FixtureNet adapter for the DP8000 must be properly configured:

1. Open the node settings window for the DP8000 that is connected via FixtureNet to the Catalyst media servers
2. Select the FixtureNet tab of the node settings window
3. Ensure that the IP address and subnet settings are appropriate for the network environment in which the Catalyst media servers are connected. This is similar to configuring the FixtureNet network adapter for Art-Net and sACN output. To better ensure connectivity it is recommended that the IP address assigned to the FixtureNet adapter be within in the same sub-network as the Catalyst it is receiving preview thumbnails from.

10.4.2 Patching Catalyst fixtures to Catalyst Media Servers

Once a Catalyst fixture is scheduled in the patch window and patched to a DMX output, the Catalyst fixture can then be patched to a Catalyst media server that is connected to the FixtureNet network of any active DP8000 connected to the console. Follow these steps to patch a Catalyst fixture to a Catalyst media server:

1. Open the patch window
2. Select the Catalyst fixture(s) you wish to associate with a Catalyst media server in the rig
3. Press the "patch media" button at the top of the patch window
4. Select the Catalyst tab in the media patch window
5. Enter the IP Address of the Catalyst media server
6. Press okay. You will now see the IP address of the Catalyst media server in the patch window listed for the Catalyst fixtures you selected in step 2. This will now associate the Catalyst fixtures in your show file with the Catalyst media servers in the rig as long as the Catalyst media server's IP remains the same.
7. With the fixtures still selected press the "refresh media" button at the top of the patch window to fetch previews from the Catalyst

**Caution**

If the IP address of a Catalyst Media server in the rig changes you will need to perform the "patch media" task again.

**Tip**

Entering an IP address of 0.0.0.0 in the Catalyst tab of the media patch window will disassociate/unpatch the selected fixtures from Catalyst media servers and revert the fixture to using the preview thumbnails in the fixture library.

10.4.3 Refreshing Catalyst Previews

Catalyst media server content may change during the programming of your show. For example, the video clip file used in the opening scene might have been changed on the Catalyst media server. The console is not automatically made aware of these content changes and so it is necessary to request new preview thumbnails from the Catalyst media server. Follow these steps to update the previews on the console:.

1. Open the patch window
2. Select the fixture(s) you wish to refresh the media
3. Press the "refresh media" button at the top of the patch window. A green and white animated refresh icon will appear at the top right of the media picker window to the right of the search field. The media refresh is finished when the icon disappears.

10.4.4 Disabling Catalyst Preview Fetching on DP8000

By default Catalyst thumbnail preview fetching is enabled on all DP8000s in new shows. To disable Catalyst thumbnail preview fetching on a DP8000:

1. Open the node settings window for the DP8000
 2. Select the Catalyst tab of the node setting window
 3. Deselect the enable button and hit apply
-

10.5 Adding Previews to Pre-v2.0.0 Show Files

Hog 4 OS and Hog 3 OS show files built with fixture library v4.7 and older will not display library based preview thumbnails in the media picker until the fixtures in the show file are updated using the follow steps:

1. Open the patch window
 2. Select the fixture(s) you wish to update with library based preview thumbnails
 3. Press the "refresh media" button at the top of the patch window
-

10.6 Renaming & Customizing Preview Images

Users can define custom names and images for fixture previews using the media picker. For example, if a fixture in the rig has a custom gobo installed the user may want to change the library defined preview image to a custom image or change the library defined preview name to a custom name in order to better represent the custom gobo being used in the rig.

Customizing preview images and/or names in your show can be done using the follow steps:

1. Open the media picker window
2. Select the fixture(s) you want to customize
3. In the media picker window select the preview you wish to change
4. Hit the [set] key
5. Use the text field to rename the preview and/or click on the "Change..." button to browse for a custom image. Images can be imported from a USB flash drive or chosen from the thumbnail library folder on the console. (supported image formats: JPEG, PNG, GIF)
6. The custom preview name and image you chose will now appear anywhere that preview is presented in the show such as on the slot toolbar, in the media picker, and in direct entry menus.

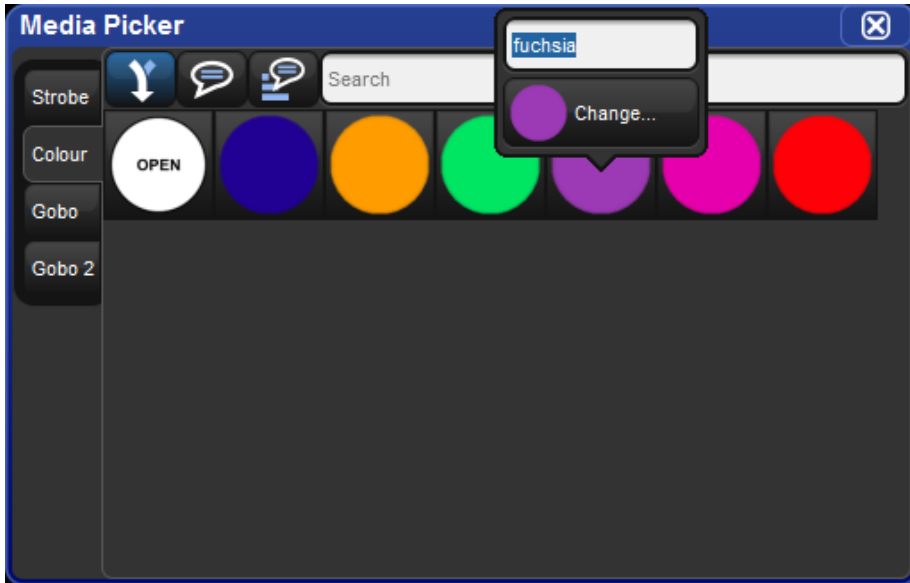

Figure 10.2. Media Picker Window

10.7 Managing Preview Packages

To **view** which preview package a fixture is using open the fixture window and locate the "preview package" column for that fixture. Listed in this column will be the name of the preview package currently being used by the fixture to display preview names and thumbnails on the slot toolbar, in the editors, and in the media picker.

To **change** which preview package a fixture is using double click on the preview package cell and select from the list of available packages in the menu.

Default Library Packages: Are the packages defined by the fixture library. These packages contain previews based on manufacturer documentation and stock fixture configuration.

Custom Packages: Are created when the user has modified the default library preview package for fixture or set of fixtures by adding custom images or names to the previews for that fixture. Once a custom package is created for one fixture, other fixtures of that same type can also be assigned to use this preview package using the fixture window.

Cached Packages: Are created when a fixture's previews are downloaded via CITP. In this case a "cached" preview package for that fixture will be created. Like custom packages, cached packages can also be assigned to other fixtures of the same type using fixture window.

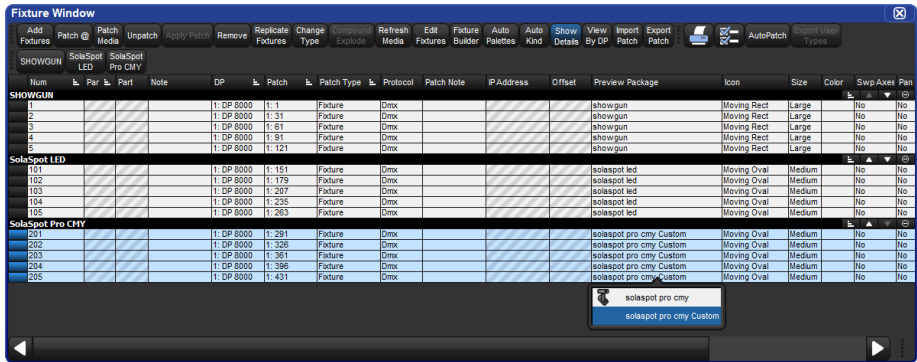

Figure 10.3. Fixture Window



Tip

Custom preview packages and CIP cached preview packages can be associated with more than one fixture of the same type. For example, you can create a custom preview package for Solaspot fixture 1 and then use the fixture window to assigned Solaspot fixtures 2<10 to the same preview package enabling those fixtures to display the same custom previews. Likewise you can utilize a single CIP cached preview package by assigning it to multiple fixtures your show.

Section 11: Cues and Cuelists

11.1 Recording a Cue

To record a look created in the Programmer or editor as a cue within a cuelist, you need to specify a cuelist and cue number to record to. If the cuelist does not yet exist, Hog 4 OS will create it automatically.

For example, to record Cue 4 into Cuelist 2:

- Record List **2** Cue **4** Enter

11.1.1 Recording to a Cuelist on a Master

You can choose a master rather than a cuelist when recording a cue. This will record the cue to the cuelist currently attached to the chosen master, or create a cuelist if it doesn't exist. For example:

1. Press the Choose key above Master number 10. The Choose key will light up to show that Master 10 is the chosen master.
2. Record **1** Enter : records Cue 1 in the cuelist attached to Master 10, creating it if necessary.

To record more cues:

- Record **1.5** Enter : inserts a new cue numbered 1.5 into the cuelist on the currently chosen master.
- Record Enter : appends the cue to the end of the cuelist attached to the currently chosen master.
- Record Choose : appends the cue to the end of the cuelist of the selected master. This allows the current master to remain chosen while recording cues onto other masters.

11.1.2 Programmer contents after Recording a Cue

When you record a cue, the values remain in the Programmer, but the background colour changes from blue to grey. This indicates that the parameter values in the Programmer are no longer **touched**, and so are available for recording to another cuelist, but not to the same cuelist. You can keep the values in the Programmer to act as the basis for the next cue on the same list, but because of tracking, only the *changed* parameter values will be recorded. For an overview of tracking, see *Tracking* (p.29).

11.1.3 Insert, Merge and Replace

When recording, copying or moving a cue, if the destination location already has a cue recorded in it, you will be prompted with record options of Insert, Merge or Replace:

- **Insert:** creates a new destination cue. The new cue will be assigned a free location lower than the one chosen, using a point number if necessary.
- **Merge:** Incorporates the new information into the destination cue. If the same fixtures and parameters are in both cues, the new values being merged will take priority.
- **Replace:** Overwrites the cue information in that destination.

If you are copying a cue, all three options are available. If you are moving a cue, only the Insert option is available.



Tip

If you know that you are about to record, copy or move a cue to an existing destination, you can pre-select Insert, Merge or Replace from the Record Options Toolbar. This appears after you press the Record, Copy or Move keys.

11.1.4 Numbering Cues

If you leave out the cue number when recording cues, Hog 4 OS will give the cue the next whole number in the list. If you specify a cue number, you can use numbers with up to five digits before the decimal and four digits after; for example: **11111.1111**. This can be useful to insert cues between previously recorded ones.

You can later renumber a complete cuelist; see *Renumbering Cues within a Cuelist (p.217)*.

11.1.5 Naming Cues

You can give a cue a name that will be displayed in the Cuelist window and on the Playback Bar:

1. Open + Choose : opens the Cuelist window of the selected master.
2. Select the cue's name cell.
3. Set **[name]** Enter : type in the name.



Tip

To name a cue immediately after recording it, press the Set key. This will open a Quickname window. Enter the cue name and select OK.

11.2 Record Options

11.2.1 Recording Selected Fixtures Only

Normally, recording a cue records the total contents of the Programmer or editor, but you can choose to record only the currently selected fixtures. For example:

1. Select the fixtures that you want to record.
2. Record
3. Press Selected on the Record Options Toolbar.
4. Choose : records the selected fixtures as a new cue in the cuelist on the selected master.

11.2.2 Record, Remove Values from Cues

You can remove the contents of the Programmer or editor from a previously recorded cue. For example, you might have made changes to a cue, and you want the changes to track through subsequent cues (see *Tracking (p.29)* for an explanation of tracking). To remove parameter values:

1. Ensure that the parameters that you want to remove are in the Programmer. The parameter values do not matter, only that the parameters have values.
2. Record, Remove : the Remove button is on the Record Options Toolbar at the bottom of the right-hand screen.
3. Cue 5, Enter : removes the selected parameter values from Cue 5.

To remove a whole fixture ensure that all parameters are selected. You can do this by selecting the fixture and pressing the Touch button on the Main Toolbar.

11.3 Deleting Cues

To delete a cue:

1. Cue 1 Delete : deletes Cue 1 in the currently chosen cuelist.
2. Click OK to confirm the delete.

Or:

1. List 1 Cue 1 Delete : deletes cue 1 in cuelist 1.

2. Click OK to confirm the delete.

**Tip**

If you prefer not to be asked to confirm the delete action, select Don't Ask Me Again in the confirmation window. You can re-enable the confirmation by going to Setup → Preferences → Programming and selecting Confirm before deleting directory items.

You can delete a range of cues:

1. List **1** Cue **1** Thru **4** Delete : deletes Cues 1 to 4 in Cuelist 1.
2. Click OK to confirm the delete.

**Tip**

To delete a cue 'cue only', so that changes caused by deleting the cue don't track through to later cues, see *Deleting without Tracking Forward* (p.222).

11.4 Copying and Moving Cues

**Tip**

Copying or moving cues affect hard values only; the cue you wish to copy/move may also contain tracked values that create the current onstage state. If you wish to copy this look rather than just changes made by the current cue, use Copy and Move with State; see *Using State* (p.222).

11.4.1 Copying Cues

To make a copy of a cue in the same cuelist:

1. Make sure that the cuelist you want to work with is on the currently chosen master.
2. Cue **1** Copy Cue **2** Enter : copies the contents of Cue 1 to Cue 2.

To copy in a cuelist other than the chosen one, or to copy between cuelists, specify the cuelist with the List key. For example:

- List **1** Cue **1** Copy List **2** Cue **2** Enter : copies the contents of Cue 1 of Cuelist 1 to Cue 2 of Cuelist 2.

To copy a range of cues:

- List **1** Cue **1** Thru **4** Copy List **2** Cue **2** Enter : copies the contents of cues 1 to 4 of Cuelist 1 to Cuelist 2, starting at Cue 2.

If the destination cue(s) already exist, you will be asked to choose an option: *Insert, Merge and Replace* (p.214).

11.4.2 Moving Cues

To move a cue to a new location:

- Cue 1 Move Cue 2 Enter : moves the cue from 1 to Cue 2, effectively removing Cue 1.

If the destination cue(s) already exist, you will be asked to choose an option: *Insert, Merge and Replace* (p.214).

11.5 Renumbering Cues within a Cuelist

If your cuelist has many point cues (1.2, 1.5, 2.5, etc.) or if cues have been deleted, you may wish to renumber the cues so that they are all whole numbers. You can renumber cuelists using the Renumber button; press More on the Main Toolbar:

- Renumber, Choose : renumber cues in the cuelist on the selected master, starting at 1 and increasing by 1.
- List 1 Cue 3 Thru Renumber, Enter : renumber all cues from Cue 3 upwards in Cuelist 1, starting at Cue 3 and increasing by 1.
- List 1 Cue 3 Thru 10 Renumber, Enter : renumber Cues 3 through 10 in Cuelist 1, starting at Cue 3, finishing at Cue 10, with other cue numbers equally spaced between.

Alternatively, you can specify the range of new numbers to be given:

- List 1 Cue 3 Renumber 5, Enter : renumber cue 3 as cue 5, in cuelist 1.
- List 1 Cue 3 Thru 10 Renumber 20, Enter : renumber cues 3 through 10, in cuelist 1, with new numbers starting at 20. The rest of the new numbers will have the same order and spacing as before.
- List 1 Cue 3 Thru 10 Renumber 20 Thru 30, Enter : renumber cues 3 through 10 in cuelist 1, starting at 20, finishing at 30, with other cue numbers equally spaced between.

Note that renumbering does not moves cues within the cuelist; if you try to renumber Cue 5 as Cue 3, you will get an error message. You should use Move for this purpose; see *Copying and Moving Cues* (p.216).



Important

Using Renumber will affect the number column and numeric entries in the Name column. Also, renumber will not rewrite macros or links that refer to renumbered cues; you will need to update these manually.

11.6 Editing Cue Contents

You can edit the contents of a cue in an editor window: see *Figure 11.1, "The Cue Editor window"*. To open the current cue of the chosen master:

- Cue, Open

Or:

- Cue, Cue

To open a specific cue in a specific cuelist, for example Cue 2 of Cuelist 1:

1. Open + List : opens the Cuelist Directory window.
2. Open + (Cuelist 1) : opens the Cuelist window for Cuelist 1.
3. Open + (Cue 2) : opens the Cue Editor for Cue 2.

Alternatively, using the command line:

- List **1** Cue **2** Open

You can also preview a cue using View Cue in the Cuelist window; however, you will need to press the Edit button in the Cue Editor window to select this as your current editor in order to make any changes.

If the cue to be edited is on stage, selecting Edit will enable blind mode until changes are updated, or Edit is deselected, see *Blind (p.285)*. You can leave the mode otherwise by pressing the Blind key.

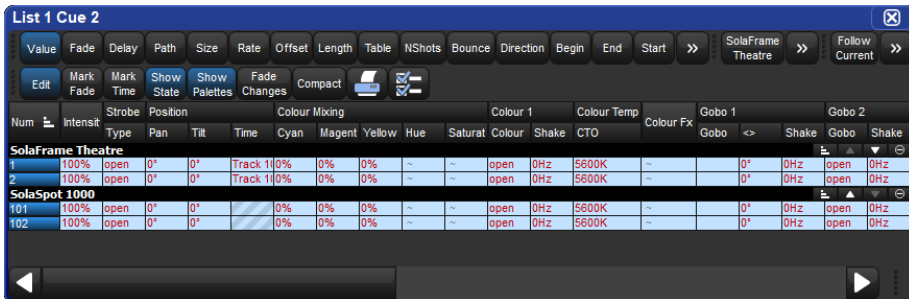

Figure 11.1. The Cue Editor window

Within the editor, you can assign fixture parameters and timing in the same way as in the Programmer. See *Selecting Fixtures and Modifying Parameters* (p.147). Once you have made changes be sure to press the Update key to save them, the Cue Editor will then automatically close.

11.6.1 Viewing Different Cues in the Editor

In addition to the usual functions available in all editors, described in *Editors* (p.43), the Cue Editor window has controls that allow you to select which cue is displayed:

- **Next and Back:** The Next and Back buttons to allow you to easily step through the cues in the cuelist to view or edit them.
- **View Cue:** You can jump to another cue by typing its number in to the View Cue box and pressing the Enter key.
- **Follow Current:** If you select the Follow Current button, the Cue Editor window will always show the current cue as the cuelist is played back. If you use Next, Back or View Cue to view another cue, or if you edit the current cue, then Follow Current is disabled.
- **Follow Next:** This is similar to Follow Current, except that the next cue is displayed rather than the current one. When the last cue is played, the first cue in the cuelist is displayed.



Tip

As well as the buttons in the Cue Editor window, you can also step through the cues using the Next and Back keys while holding down the Cue key.

11.7 Working with Tracking

Hog 4 OS uses tracking, which gives it some very powerful abilities. Tracking can also add extra complexity, but Hog 4 OS has several functions that make working with tracking straightforward. For a detailed discussion about tracking, see *Tracking* (p.29).

11.7.1 Tracking Values Backwards When Recording

You can use the Track Backwards feature when you record a cue to assign the parameter values to the last cue they appeared in, rather than the cue being recorded. For example, suppose that you have a series of cues with intensity values for three fixtures:

Fixture:	1	2	3
Cue 1	50	50	50
Cue 2	60	60	
Cue 3	70		

If you assign all three fixtures to 100% and record with merge into Cue 3 (see *Insert, Merge and Replace* (p.214) for recording with merging), you would get these values:

Fixture:	1	2	3
Cue 1	50	50	50
Cue 2	60	60	
Cue 3	100	100	100

However, if you did the same thing with Track Backwards, you would get:

Fixture:	1	2	3
Cue 1	50	50	100
Cue 2	60	100	
Cue 3	100		

The value of 100% has been applied to the last cue that the intensity parameter had a value in.

If you Track Backwards a parameter that hasn't been given a value since the start of the cuelist, the value is added to the first cue in the cuelist.

To record a cue with Track Backwards, select the Track Backward button on the Record Options Toolbar that appears after you press the Record key:

1. Fixture **1** Thru **3** @ **100** Enter.
2. Record Cue **3**
3. Select Track Backwards on the Record Options Toolbar.
4. Enter



Tip

You can also Track Backwards when you update cues using Auto Update; see *Auto Update* (p.283).

11.7.2 Stopping Values from Tracking Forward

When you insert a new cue into a cuelist, or merge changes into an existing cue, the new values track forwards into later cues in the cuelist. For example, your cuelist has Cues 1 to 4, and Cue 1 has Fixture 1 programmed into it at 30%, so that it tracks through the subsequent cues:

Fixture:	1	2	3
Cue 1	30	50	100
Cue 2		100	60
Cue 3			50
Cue 4		40	

You now insert a Cue 2.5 with Fixture 1 at 100%. Because cues 3 and 4 do not change the intensity of Fixture 1, it will remain at 100% for the rest of the cuelist:

Fixture:	1	2	3
Cue 1	30	50	100
Cue 2		100	60
Cue 2.5	100		
Cue 3			50
Cue 4		40	

You may want to record the new cue so that parameter values in the new cue return to their original value in the next cue (so that the inserted cue does not change the original looks due to tracking):

Fixture:	1	2	3
Cue 1	30	50	100
Cue 2		100	60
Cue 2.5	100		
Cue 3	30		50
Cue 4		40	

Hog 4 OS allows you to record a cue between other cues without destroying existing tracking values. To do this, record the inserted cue without tracking forwards by deselecting the Track Forward button on the Record Options Toolbar that appears after pressing the Record key. For example:

1. Press the Record key.
2. Deselect Track Forward on the Record Options Toolbar.
3. Cue **2.5** Enter : insert Cue 2.5 into the cuelist on the currently chosen master.

This is sometimes referred to as recording 'cue only' as the changes only affect the recorded cue and do not track into subsequent cues. Note that you can only turn tracking forwards off when you insert a new cue into a cuelist or when you merge values into a cue, not when adding new cues to the end of a cuelist.



Important

When recording or merging as 'cue only' any parameter values that did not previously exist in a cuelist, an 'Off' indication will be placed into the subsequent cue for these parameters. This Off indication will release the parameter value back to its previous state (as if it were not programmed in the list).

11.7.3 Deleting without Tracking Forward

When you delete a cue, this can have unexpected consequences on later cues in the cuelist if the deleted cue contained parameter values that tracked through to contribute to the state of the later cues. For example, you have the following cues:

Fixture:	1	2	3
Cue 1	30	50	100
Cue 2	100	80	60
Cue 3			50
Cue 4		40	

If you now delete Cue 2, Fixture 1 will track from Cue 1 through Cues 3 and 4 at 30%, rather than going to the expected 100% in Cues 3 and 4:

Fixture:	1	2	3
Cue 1	30	50	100
Cue 3			50
Cue 4		40	

You can prevent this happening by deleting the cue 'cue only' which adds any values that previously tracked through from the deleted cue into the next cue:

Fixture:	1	2	3
Cue 1	30	50	100
Cue 3	100	80	50
Cue 4		40	

To delete a cue without tracking the changes forwards:

1. List **1** Cue **3** : select the cue to be deleted.
2. Press and hold the Delete key. The Record Options Toolbar will appear.
3. Deselect Track Forward from the Record Options Toolbar.
4. Release the Delete key.

11.7.4 Blocking Cues

Blocking cues prevent changes made earlier in the cuelist from tracking through to subsequent cues in the cuelist.

Using State

You can create blocking cues using the State button on the Record Options Toolbar. For example, suppose that you have the following cues:

Fixture:	1	2	3
Cue 1	30	50	100
Cue 2		100	60
Cue 3			50
Cue 4		40	

to turn Cue 4 into a blocking cue, you copy it to itself 'with state':

1. Cue 4 Copy State Cue 4 Enter : the State button is on the Record Options Toolbar that appears when you press Copy.
2. Select Replace.

The values are now:

Fixture:	1	2	3
Cue 1	30	50	100
Cue 2		100	60
Cue 3			50
Cue 4	30	40	50

Because of tracking, when you copy a cue to another location you only copy the **hard values**, so you do not create a new cue that actually represents the on-stage look that you would get by running the original cue.

To copy both hard and tracked values, you can use Copy and State:

- List 1 Cue 5 Copy State List 2 Cue 1 Enter : creates a new cue in Cuelist 2 that is the state of Cue 5 in Cuelist 1.

11.7.5 Unblocking

Unblocking removes redundant hard parameter values. A parameter value is redundant in a cue if it is the same as the value for that parameter in the previous cue in the same cuelist. For example:

Channel:	1	2	3	4
Cue 1	100	0	50	50
Cue 2	50		100	
Cue 3	50	100	100	50

In this cuelist, the values for channels 1, 3 and 4 are redundant in cue 3. After unblocking, the values in the cuelist would be:

Channel:	1	2	3	4
Cue 1	100	0	50	50
Cue 2	50		100	
Cue 3		100		

To unblock cues, use the Unblock button in the Main Toolbar:

- Cue3Unblock, Enter : unblock cue 3 on the currently chosen master.
- List1Cue3Unblock, Enter : unblock cue 3 of cuelist 1.
- Cue 1 Thru 10 Colour Unblock, Enter : unblock only colour parameters in cues 1 through 10 of the cuelist on the currently chosen master.
- List 1 Cue 3 Group 10 Colour Unblock, Enter : unblock only the colour parameters of fixtures in Group 3, in cue 3 of cuelist 1.

To unblock complete cuelists:

- List 1 Unblock, Enter

Or on a master:

- Unblock Choose



Tip

Unblocking obeys the linked parameter preferences assigned in Setup → Preferences → Programming. For example, if position parameters are not separated and Pan is blocking but Tilt is not, Pan will not be unblocked. For more on linked functions, see *Separating Parameters* (p. 176)



Important

Unblocking will remove parameter values from blocking cues, so any future changes to subsequent cues will be tracked through the whole cuelist.

11.8 Mark Cues (Move in Black)

A Mark cue is a special designator for a cue that looks at the previous cue and any fixtures with an intensity of zero after completion of the cue. If a fixture meets these requirements, the mark cue allows the fixture(s) to 'preset' for the next cue by executing the cross-fade for all parameters except intensity. This allows the fixture(s) to 'move in black' as they change to their new parameter values. When the next cue is later executed, only the intensity parameter changes as all other parameters will already be at their new values due to the mark. The timing used to mark a cue is determined by the mark method you

choose. See *Fade Mark versus Time Marks* (p.226) for details on the different timing methods you can use when marking cues.

11.8.1 How to Mark to a Cue

There are several methods to assign a cue to mark:

- Select the Mark cell of a cue, press Set, and then Enter. If you wish to "time mark" the cue, then first input a time using the keypad and then Enter. To remove the mark from a cue select the Mark cell of the cue, press Set, hit Backspace, and then Enter.

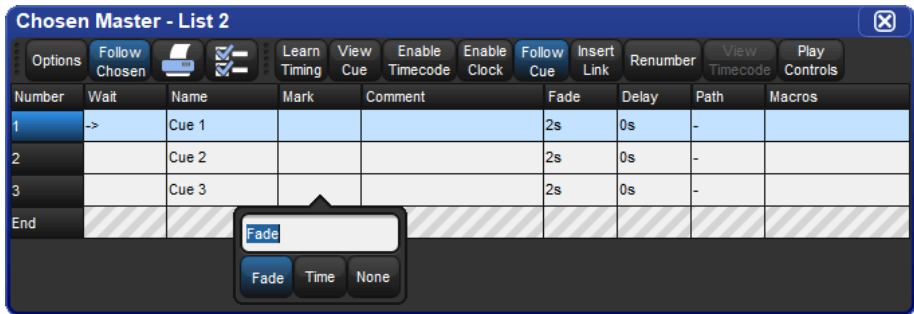

- Enable the Mark Fade New Cues or Mark Time New Cues option in the Cuelist Options window. All new cues will be created with the mark type. Note that when Mark Time New Cues is selected all newly recorded cues will get a 2s mark time by default.

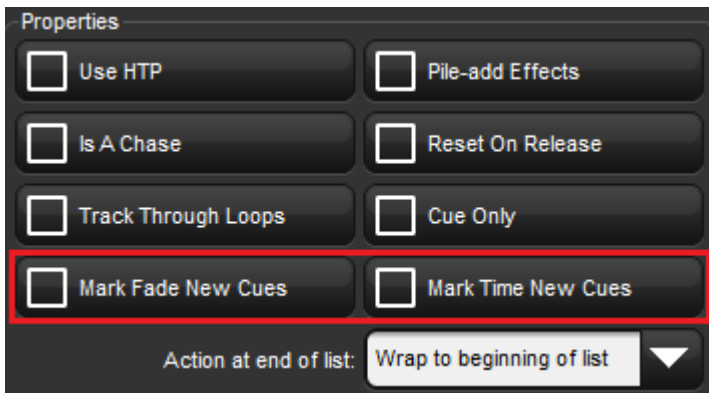

- Toggle the Mark Fade or Mark Time button in a Cue Editor window of the cue you wish to mark.

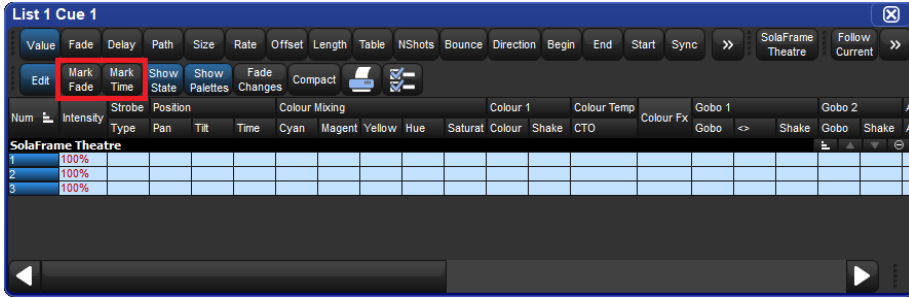

11.8.2 Fade Mark versus Time Marks

Cues can be marked with either a *fade mark* or a *time mark*. While the basic principles of marking are the still the same, the timing in which the mark is executed varies between the two methods.

A *Fade mark* uses the fade and delay times assigned in the marked cue to mark fixtures. Fade marking occurs on a fixture by fixture basis, so several fixtures could be marking at different times and rates depending upon their individual cue data in the marked cue.

In the fade mark example below, when cue 2 completes its 2 second fade to 0% intensity, cue 3 will automatically play all of its data except intensity in a 5 second fade. Then when cue 3 is played only the intensity will cross-fade at 5 seconds. The fixtures will have moved from centre to left and changed from red to green automatically while in 'black'.

	Mark	Fade	Intensity	Position	Colour
Cue 1		2s	100%	Centre	Red
Cue 2		2s	0%	Centre	Red
Cue 3	Fade	5s	100%	Left	Green

A *Time mark* uses the time you enter into the mark column to mark fixtures. Time marking occurs at a single uniform rate so all fixture parameters will mark at the same rate regardless of the data in the next cue.

In the time mark example below, when cue 2 completes its 2 second fade to 0% intensity, cue 3 will automatically play all of its data except intensity in a 0s second fade. Then when cue 3 is played only the intensity will cross-fade at 5 seconds. The fixtures will have moved from centre to left and changed from red to green automatically while in 'black'.

	Mark	Fade	Intensity	Position	Colour
Cue 1		2s	100%	Centre	Red
Cue 2		2s	0%	Centre	Red
Cue 3	0s	5s	100%	Left	Green



Tip

Marking occurs with the intensity parameter for standard fixtures as well as I Red, I Green, and I Blue parameters for RGB fixtures such as LEDs.

11.8.3 Marking the First Cue in a Cue List

If the first cue in a list is assigned to mark, it will only mark after the last cue in the list is played. By recording a blank cue prior to the first cue in the list, you can create a mark cue for the first look of a show. For example:

	Mark	Fade	Intensity	Position	Colour
Cue 0.5	-	-	-	-	-
Cue 1	Fade	0,2s	100%	Right	Blue
Cue 2		2s	50%	Left	-

When cue 0.5 plays it will mark cue 1 so that cue 1 will fade up intensities on stage after the fixtures are already in position and color. Furthermore, since the intensity time of cue 1 is assigned to 2 seconds and the other parameters are assigned to zero, the mark cue will occur as quickly as possible.

11.8.4 Cuelist Feedback for Mark Cues

The following figures show the different states of a marking cue.

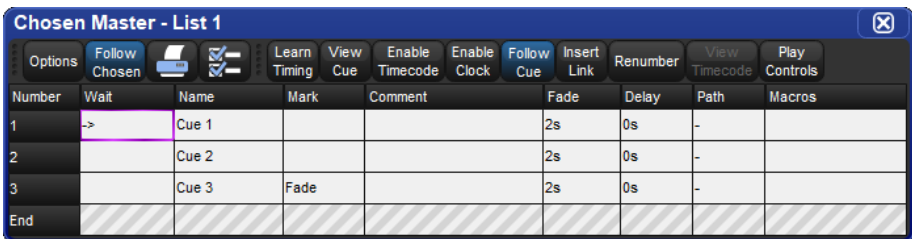

Figure 11.2. Cue 3 with a Fade Mark

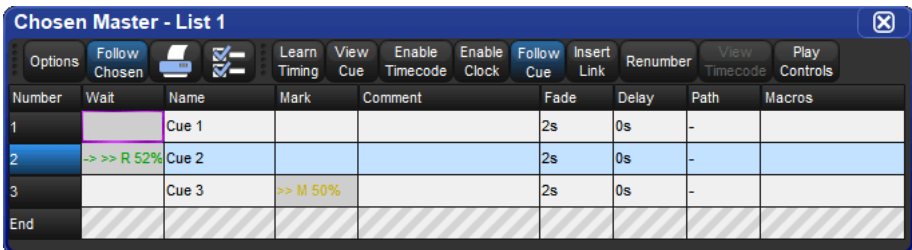

Figure 11.3. Cue 3 Actively Fading into its Mark

Number	Wait	Name	Mark	Comment	Fade	Delay	Path	Macros
1		Cue 1			2s	0s	-	
2	->	Cue 2			2s	0s	-	
3		Cue 3	Fade		2s	0s	-	
End								

Figure 11.4. Cue 3 Fully Marked

11.9 Understanding Cuelists

Cuelists are lists of cues, usually used to play back the cues in a defined order. A cue number is specific to each cuelist, not the entire console, so there can be a cue 1 for cuelists 1, 2 and 3. Cuelists are held in the Cuelist Directory (Figure 11.5, “The Cuelist Directory window”), and it is possible to copy or move cues between cuelists; see *Copying and Moving Cues* (p.216).

To open the Cuelist Directory:

- Open + List

Alternatively:

- List, List

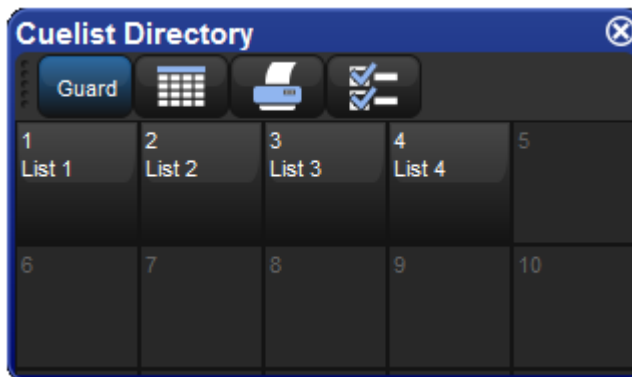

Figure 11.5. The Cuelist Directory window

To open a cuelist (Figure 11.6, “The Cuelist window”):

- Open + [Cuelist 1] : select a cuelist from the Cuelist Directory.

Or with the command line:

- List 1 Open

Or:

- Open + Choose : select the master with the cuelist.



Tip

Cuelist windows can be set to always show the same cuelist or to follow the currently chosen master: see *Cuelist Feedback* (p.314).

11.10 Naming Cuelists

You can name cuelists:

1. Open + List : open the Cuelist Directory.
2. Check that the Guard button is selected, so that you don't accidentally activate a cuelist when pressing its button in the directory.
3. Select the cuelist.
4. Set [name] Enter : type in the name.



Tip

You can rename a cuelist when it is attached to a master by pressing Set + Choose.

11.11 Deleting Cuelists

To delete a cuelist:

1. List 1 Delete : deletes cuelist 1.
2. Click OK to confirm the delete.

Or from the cuelist directory:

1. Open + List : open cuelist directory.
2. Check that the Guard button is selected, so that you don't accidentally activate a cuelist when pressing its button in the directory.
3. Delete, (Cuelist 1) : delete the cuelist. You will be asked to confirm the action.

Number	Wait	Name	Mark	Comment	Fade	Delay	Path	Macros
1	->	Cue 1			2s,3s,5s,7s	0s	-	
2		Cue 2			2s	0s	-	
3		Cue 3			2s	0s	-	
End								

Figure 11.6. The Cuelist window

**Tip**

If you prefer not to be asked to confirm the delete action, select Don't Ask Me Again in the confirmation window. You can re-enable the confirmation by going to Setup → Preferences → Programming and selecting Confirm before deleting directory items.

**Tip**

To detach a cuelist from its master rather than deleting it completely from the show file, hold Delete while pressing the master's Choose button. This removes the cuelist from the master but not from the cuelist directory.

11.12 Copying and Moving Cuelists

Cuelists can be copied and moved within the Cuelist Directory. To open the Cuelist Directory:

- Open + List

11.12.1 Copying Cuelists

To make a copy of a cuelist:

- List 1 Copy List 2 Enter : copies Cuelist 1 to Cuelist 2.

If the destination cuelist already exists, you will be asked to choose an option: *Insert, Merge and Replace* (p.231).

11.12.2 Moving Cuelists

To move a cuelist to a new location within the Cuelist Directory:

- List 1 Move List 2 Enter : moves Cuelist 1 to Cuelist 2.

If the destination cuelist already exists, you will be asked to choose an option: *Insert, Merge and Replace* (p.231).

11.12.3 Insert, Merge and Replace

When copying or moving a cuelist, if the destination location already has a cuelist in it, you will be prompted with record options of Insert, Merge or Replace:

- **Insert:** creates a new destination cuelist. The new cuelist will be assigned a free location just before the one chosen, using a point number if necessary.
- **Merge:** Incorporates the source information into the destination cuelist. If the cue numbers are in both cuelists, the new parameter values of the cues will replace the old.
- **Replace:** Overwrites the cuelist information in that destination.

If you are copying a cuelist, all three options are available. If you are moving a cuelist, only the Insert option is available.



Tip

If you know that you are about to copy or move a cuelist to an existing destination, you can pre-select Insert, Merge or Replace from the Record Options Toolbar. This appears after you press the Record, Copy or Move keys.

Section 12: Scenes

12.1 Recording Scenes

You can record scenes either directly to a physical master for immediate playback, or to the Scene Directory.

12.1.1 Recording to the Scene Directory

To record a scene:

1. Create the look for the scene in the Programmer or editor.
2. Record, Scene : the Scene Directory window opens.
3. Select the destination location in the Scene Directory window.
4. Alternatively, enter a number on the keypad and press Enter.

12.1.2 Recording to a Physical Master

You can record a scene directly to a physical master. Hog 4 OS will automatically put it in the next available location in the Scene Directory:

1. Create the look for the scene in the Programmer or editor.
2. Record, Scene
3. Press the Choose key above the desired physical master.

12.1.3 Naming a Scene

You can give a scene a name that will be displayed in the Scene Directory window:

1. Open + Scene : open the Scene Directory.
2. Check that the Guard button is selected, so that you don't accidentally activate a scene when pressing its button in the directory.
3. Select the scene.
4. Set [**name**] Enter : type in the name.



Tip

To name a scene immediately after recording it, pressing the Set key will open a Quickname window. Enter the scene name and select OK.

12.2 Deleting Scenes

To delete a scene:

1. Scene 1 Delete
2. Click OK to confirm the delete.



Tip

If you prefer not to be asked to confirm the delete action, select Don't Ask Me Again in the confirmation window. You can re-enable the confirmation by going to Setup → Preferences → Programming and selecting Confirm before deleting directory items.

You can delete a range of scenes:

1. Scene 1 Thru 4 Delete : deletes scenes 1 to 4.
2. Click OK to confirm the delete.



Tip

To detach a scene from its master rather than deleting it completely, hold Delete while pressing the master's Choose button. This removes the scene from the master but not from the scene directory.

12.3 Copying and Moving Scenes

To make a copy of a scene:

- Scene 1 Copy Scene 2 Enter : copies the contents of Scene 1 to Scene 2.

Similarly, to move a scene to a new location:

- Scene 1 Move Scene 2 Enter : moves Scene 1 to Scene 2, effectively deleting 1.

If the destination scene already exists, you will be asked to choose an option: *Insert*, *Merge and Replace* (p.235).

12.4 Editing Scene Contents

You can edit the contents of a scene in an editor window. For example, to open Scene 1 for editing:

1. Open + Scene : opens the Scene Directory.
2. Open + (Scene 1) : opens the scene editor for Scene 1.
3. Alternatively using the command line : Scene 1 Open
4. Press the Edit button in the editor window to select this as your current editor.

Within the editor, you can assign fixture parameters and timing in the same way as in the Programmer; see *Selecting Fixtures and Modifying Parameters* (p.147). For general information on working with editors, see *Editors* (p.43).

12.5 Scene Timing

Scene timing controls the fade-in and delay of a scene when it is run on a master.

You assign and edit scene timings in the same way as for cues; see *Fade, Delay, and Path* (p.238). You can assign scene timing in the Programmer before recording the scene, or later in the scene editor. You can also assign the fade time of a scene from the command line. For example, to give Scene 1 a fade time of 6 seconds:

- Scene 1 Time 6 Enter

You can also record fade times with a mask. For example:

- Scene 1 Fixture 1 + 2 Colour Time 4 Enter : sets the fade time for the colour parameter values of fixtures 1 and 2 in Scene 1.
-

12.6 Insert, Merge and Replace

When recording, copying or moving a scene, if the destination location already has a scene recorded in it, you will be prompted with record options of Insert, Merge or Replace:

- **Insert:** creates a new destination scene. The new scene will be assigned a free location just before the one chosen, using a point number if necessary.

- **Merge:** Incorporates the new information into the destination scene. If the same fixture parameters are in both scenes, the new values will replace the old.
- **Replace:** Overwrites the scene information in that destination.

If you are copying a scene, all three options are available. If you are moving a scene, only the Insert option is available.



Tip

If you know that you are about to record, copy or move a scene to an existing destination, you can pre-select Insert, Merge or Replace from the Record Options Toolbar. This appears after you press the Record, Copy or Move keys.

12.7 Toggling Scenes On/Off in Playback

To configure a scene so that it can be toggled on/off in the scene directory, open the options window for the scene and look for an option called “action at end of scene”. Choose one of the following options that provides “toggle-like” functionality:

- **Add Release End Cue:** The scene will release when played if it is already onstage. This option allows for the scene to be manually toggled on/off by pressing its cell in the scene directory when guard is turned off.
- **Auto-Release at End:** The scene will automatically release after its cross-fade is complete. This option is useful for users who want to trigger a scene and have it automatically release on its own. To extend the period for which a scene is in playback before it is automatically released, record a dummy desk channel into the scene with a cross fade that is equal to the length of time you want the scene to be onstage before it releases.

Section 13: Timing

13.1 Timing Basics

With Hog 4 OS you can assign individual cross-fade timings for each parameter of each fixture, giving you complete control of how each parameter changes during a cue. Because of this, there are no cue parts as found on some other consoles. Hog 4 OS gives you easy ways to assign timings for the whole cue, for individual fixtures and by parameter type (intensity, position, colour, beam, and so on) as well as for each parameter.

You can control three aspects of timing in the Hog 4 OS:

- The speed and manner in which the transition of parameter values happens when a cue/scene is played back. See *Fade, Delay, and Path* (p.238).
- The time a cue/scene waits before it is triggered. See *Cue Wait Timing* (p.249).
- The order in which cues in a cuelist are played back. See *Loops and Links* (p.254).

The different types of timing values are:

- **Fade time:** The time that it takes fixture parameters to change from their initial value to their value in the cue that is being played back. You can assign a single fade time for the cue, or have separate fade-in and fade-out times. The fade-in time is the fade time for parameters belonging to fixtures that are increasing in intensity, while the fade-out time is the fade time for parameters belonging to fixtures that are decreasing in intensity.
- **Delay time:** The time between the cue being triggered and parameter values starting to change. As with fade times, you can assign a single delay time, or have separate in delay and out delay times. The in delay time is the delay between the cue being triggered and parameters belonging to fixtures that are increasing in intensity starting to change, while the out delay time is the delay between the cue being triggered and parameters belonging to fixtures that are decreasing in intensity starting to change.
- **Path:** How parameter values change during the fade. The simplest path is a straight line, so that parameter values change smoothly and evenly throughout the fade, but you can use paths that make all of the change happen at the start of the fade, for example.

The different types of trigger values are:

- **Wait time:** The time from the previous cue being triggered to the current cue being triggered.
- **Follow-on time:** The time from the end of the previous cue to the current cue being triggered.
- **Timecode:** A specific timecode value when a cue is triggered; see *Triggering Cues from MIDI Timecode* (p.379).
- **Clock:** A real-world time and date value when a cue is triggered; see *Clock Triggers* (p.251).

Figure 13.1, “Cue timings” shows how the main kinds of timing and triggering values control the playback of cues.

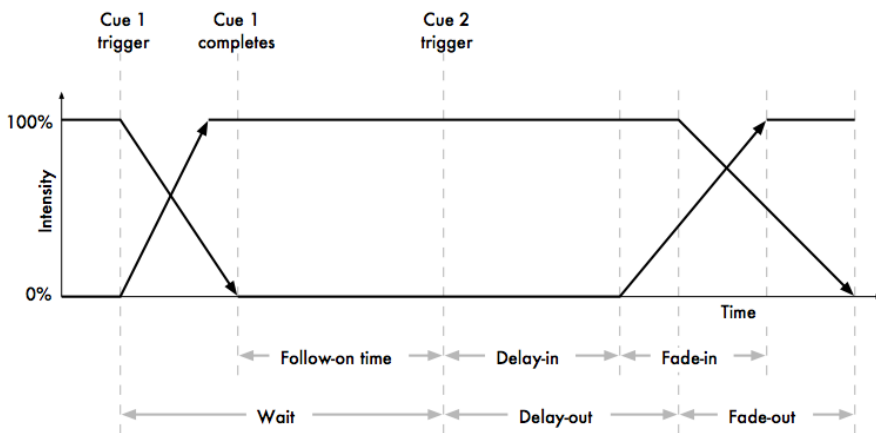

Figure 13.1. Cue timings

Hog 4 OS allows you to assign timings to each parameter of each fixture in a cue, scene or palette. Often, you will want to assign the same value to every fixture parameter; this is described in *Fade, Delay, and Path* (p.238). Assigning timings for individual parameters is described in *Individual Parameter Timings* (p.243).

13.2 Fade, Delay, and Path

You can assign **fade** time and **delay** times, as well as **paths**, to cues and scenes. Cues recorded without assigning any time information will be given the default time; this can be adjusted in the Default Timing pane of the User Preferences window.

13.2.1 Fade Time

To record a cue with a fade time other than the default:

1. Create the desired look for the cue in the Programmer.
2. Fixture Enter : select all the fixtures currently in the Programmer.
3. Time 7 Enter : assign a fade time of 7 seconds.
4. Record Cue 1 Enter : record the cue on the currently chosen master.

To assign times greater than 1 minute, enter the number of minutes followed by the number of seconds:

- Time 140 Enter : select a fade time of 1 minute 40 seconds.

To change the time of an already recorded cue:

1. Cuelist 1 : select the cuelist unless the desired cuelist or master is already the chosen master.
2. Cue 2 Time 7 Enter : assigns a fade time of 7 seconds.

Different Fade-in and Fade-out Times

You can assign different fade-in and fade-out times (known as a 'split time') using the / key. For example:

1. Create the desired look for the cue in the Programmer.
2. Fixture Enter : select all the fixtures currently in the Programmer.
3. Time 7 / 10 Enter : select a fade-in time of 7 seconds, and a fade-out time of 10 seconds.
4. Record : record the cue on the currently selected master.



Important

Hog 4 OS's definition of fade-in and fade-out times is different to that used by some other consoles. Some consoles use fade-in and fade-out times for intensity parameters only and have a separate time for all other parameters; Hog 4 OS has fade-in and fade-out times for each individual parameter. Also, with some consoles the fade-out time applies when the cue goes out, so that cue 2's fade-out time takes effect during the change from cue 2 to cue 3 rather than (as with Hog 4 OS) cue 1 to cue 2.

Fade Time with Masks

You can record fade times with a mask. For example:

- Cue 1 Fixture 1 + 2 Colour Time 4 Enter : sets the fade time for the colour parameter values of Fixtures 1 and 2 in Cue 1.

**Tip**

If you want to assign individual times for several fixtures or fixture parameters, you can edit them in the Cue Editor window by clicking on its Fade button; see *Individual Parameter Timings* (p.243).

13.2.2 Delay Time

You can create a delay between the cue being triggered and the fade times beginning to execute by assigning the Delay time:

1. List **1** Open : open the cuelist.
2. Select the cue's Delay cell and press Set.
3. **5**, Enter : enter the delay time. As with fade times you can assign separate delay times for the incoming and outgoing parts of the cue, for example **3/5**.

Alternatively, you can use the command line, pressing the Time key twice to assign the delay time:

- Cue **2** Time Time **5** Enter

**Tip**

Note that the Delay time should not be confused with the Wait time; see *Cue Wait Timing* (p.249).

13.2.3 Paths

Paths determine the way parameter values change during a cue. For example, with the simplest (linear) path, an intensity parameter travels from its start value to its end value at a steady rate for the duration of the cue. The paths available are shown in *Figure 13.2, "Path Types"*.

To select a path for a cue:

1. List **1** Open : open the Cuelist window.
2. Select the cue's Path cell and press Set. The Crossfade Paths window will open.
3. Select the path type required for the incoming and outgoing parts of the cue.
4. Press OK

**Tip**

The shape of the paths described above applies when the cue is asserted. When it is released, the path is effectively reversed. For example, attributes









Path		Description
Default		Uses the default path from the fixture's library definition. This is generally Linear for continuous parameters and Start for slotted parameters.
Linear		Fades at a steady rate for the duration of the cue.
Start		Snap change at the beginning of the cue.
End		Snap change at the end of the cue.
Over		The parameters overshoot their destination and then return to it.
Under		The parameters move first in the opposite direction before going to their destination.
Damped		The parameters change more slowly at the start and end of the cue than in the middle.
Brake		The parameters change more slowly at the end of the cue.
Speed Up		The parameters change more slowly at the start of the cue.
Shake		The parameters follow a chaotic, sawtooth fade over the course of the cue.

Figure 13.2. Path Types

with a 'Start' path will snap on the Go of a cue, but will snap at the very end of that cue being released (behaving like an 'End' path).

13.2.4 Assigning Cue Timings in the Cuelist Window

You can edit fade or delay times in the Cuelist window. Assigning fade or delay times here will assign the new value to all the parameters of all the fixtures in the cue.

1. Open + Choose : open the cuelist of the desired master.
2. Click in the cell for the fade or delay time of the desired cue, and press Set.
3. Type in a time value, and press Enter.

When entering a time value, it should be in the form:

[hours] h [minutes] m [seconds] s / [hours] h [minutes] m [seconds] s

For example:

- **2s** : 2 seconds in and out times.
- **2s/5s** : 2 seconds in, 5 seconds out.
- **1m** : 1 minute in and out times.
- **1m10s** : 1 minute and 10 seconds in and out times.
- **1h10m30s/1h** : 1 hour, 10 minutes and 30 seconds in time, and 1 hour out time.

Use the H, M and S buttons that appear when editing a fade or delay time cell to enter the H, M and S text into the cell. Alternatively, you can use an external keyboard.

Note that if you enter **140** the time will be 1 minute 40 seconds, not 140 seconds (2 minutes 20 seconds).

To assign paths directly in the Cuelist window:

1. Click in the Path cell for the desired cue, and press Set.
2. Choose a path from the displayed list; see *Figure 13.3, "Selecting a Path in a Cuelist Window"*.

The In path is applied when a fixture is increasing in intensity during the cross-fade, and the Out path when a fixture is decreasing in intensity.

3. Press OK.



Figure 13.3. Selecting a Path in a Cuelist Window

The different types of path are explained in *Paths* (p.240).

13.3 Individual Parameter Timings

When you record a cue, all of the fixture parameters in the cue are assigned the default fade, delay and path values. Similarly, when you assign timings to a cue after recording, the timing value is applied to all fixture parameters in the cue. However, you can assign fade, delay or path values to individual parameters in the Programmer, and these settings are then included when you record cues and scenes, and (optionally) palettes. You can also assign timings to parameters in the cue, scene and palette editors. Note that you can only assign timings for a parameter that has a value in the editor.

To display parameter fade times, delay times or paths in an editor, select the Fade, Delay or Path buttons from the top left of the editor window.

You can assign the individual timings of parameters using the parameter wheels, the command line or directly in editor windows. You can also assign timings to all parameters of a fixture using the parameter wheels or the command line.



Important

If you assign individual timings for parameters and subsequently assign an overall cue time, then the individual parameter timings will be replaced by the overall cue time.

13.3.1 Assign Parameter Timings using Wheels

To assign fade and delay timings to all the parameters of a fixture:

1. Select the fixtures that you want to assign timings to, making sure that they have been given parameter values.
2. Press the Time key.
3. The Wheels Toolbar will show the available timing types (Fade In, Fade Out, Delay In and Delay Out) together with their current settings; see *Figure 13.4, “The Wheels Toolbar showing Timing”*.
4. Use the parameter wheels to assign the desired Fade In, Fade Out, Delay In and Delay Out.

Note that if you want to see the timings that you have assigned in the editor, you can select the Fade or Delay views using the buttons in the top left of the editor window. You don't have to be in these views to assign timings, however.



Figure 13.4. The Wheels Toolbar showing Timing

To assign fade and delay timings to specific parameter types:

1. Select the fixtures that you want to assign timings to, making sure that they have been given parameter values.
2. Press the Time key.
3. The Wheels Toolbar will show the available timing types.
4. Click on Fade In, Fade Out, Delay In or Delay Out and select a parameter type; see *Figure 13.5, “Selecting Parameter Types from the Wheels Toolbar”*.
5. Use the parameter wheels to assign the desired timing.



Figure 13.5. Selecting Parameter Types from the Wheels Toolbar

To assign a path to all the parameters of a fixture:

1. Select the fixtures that you want to assign a path to, making sure that they have been given parameter values.
2. Press the Time key.
3. The Slot Toolbar will show buttons for All, In and Out; see *Figure 13.6, "The Slot Toolbar showing Paths"*.
4. Choose In to assign a path to be applied to the parameters when the fixture they belong to is increasing in intensity during the cross-fade. Choose Out to assign a path to be applied to parameters when the fixture they belong to is decreasing in intensity during the cross-fade. Choose All to assign a path to be applied to parameters of fixtures irrespective of whether their intensity is increasing or decreasing.

The Paths Toolbar will open; see *Figure 13.7, "The Paths Toolbar"*.

5. Select the desired path from the Paths Toolbar. The different types of path are explained in *Paths (p.240)*.



Figure 13.6. The Slot Toolbar showing Paths

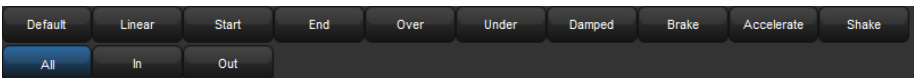

Figure 13.7. The Paths Toolbar

13.3.2 Assign Parameter Timings with the Command Line

To assign the fade time for all parameters of a fixture:

1. Fixture 1 : select the fixtures you want to assign a time to, making sure that they have been given parameter values.

2. Time **4**, Enter : assigns the **fade time** to 4 seconds.

To assign separate fade in and fade out times:

1. Fixture **1** : select the fixtures you want to assign a time to, making sure that they have been given parameter values.
2. Time **4 / 7**, Enter : assigns the Fade In time to 4 seconds and the Fade Out time to 7 seconds.

To assign a fade time for a particular parameter type:

1. Fixture **1** : select the desired fixtures.
2. Colour Time **4**, Enter : assigns the fade time of the colour parameters to 4 seconds.

To assign a delay time, press the Time key twice:

1. Fixture **1** : select the desired fixtures.
2. Time Time **2**, Enter : pressing Time twice assigns the **delay time**.

To assign a path, press the Time key three times:

1. Fixture **1** : select the desired fixtures.
2. Time Time Time **2**, Enter : enter a number to represent the path.

Select the path by entering a number; the mapping is the same as the order they appear on the path toolbar, starting at zero for the default path.

13.3.3 Assign Parameter Timings in an Editor

To assign fade or delay times directly in the spreadsheet of an editor:

1. View the required timing type by pressing either the Fade or Delay button in the top left of the editor window.
2. Click in the cell for the desired parameter, or click and drag to select a range of cells.
3. Press Set.
4. Type in a time value, and press Enter.

When entering a time value, it should be in the form:

- **[hours] h [minutes] m [seconds] s / [hours] h [minutes] m [seconds] s**

For example:

- **2s** : 2 seconds in and out times.

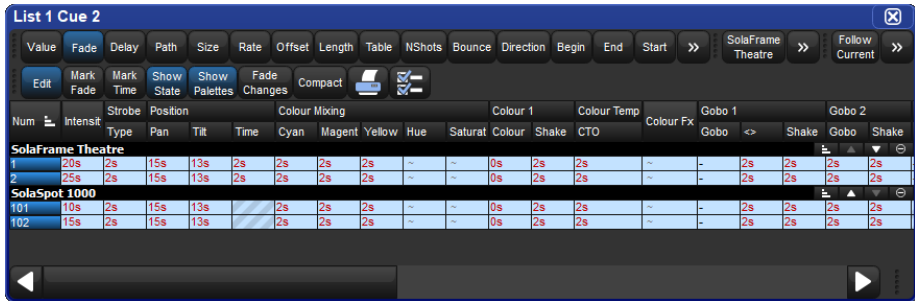

Figure 13.8. The Cue Editor window with Fade selected

- **2s / 5s** : 2 seconds in, 5 seconds out.
- **1m** : 1 minute in and out times.
- **1m10s** : 1 minute and 10 seconds in and out times.
- **1h10m30s / 1h** : 1 hour, 10 minutes and 30 seconds in time, and 1 hour out time.

Use the H, M and S buttons that appear when editing a fade or delay time cell to enter the H, M and S text into the cell. Alternatively, you can use an external keyboard.



Tip

If you enter **120**, this will be interpreted as 1 minute 20 seconds. To have the console interpret it as 120 seconds (i.e. 2 minutes), enter **120s**.

To assign paths directly in the spreadsheet of an editor:

1. Press the Path button in the top left of the editor window.
2. Click in the cell for the desired parameter, or click and drag to select a range of cells.
3. Press Set.
4. Choose a path from the displayed list; see Figure 13.9, "Selecting a Path in an Editor".

The In path is applied when the fixture is increasing in intensity during the cross-fade, and the Out path when the fixture is decreasing in intensity.

5. Press OK.



Figure 13.9. Selecting a Path in an Editor

The different types of path are explained in *Paths* (p.240).

13.3.4 Fanned Timings

You can fan timings across multiple fixtures, just as you can fan colour or position. For example, to fan times across 10 fixtures:

- Fixture **1** Thru **10** Time **5** Thru **14** Enter : fans the fade times of Fixtures 1 through 10 between 5 and 14 seconds:

Num ▲	Intensity	Strobe Type
Studio Color 575		
1	5s	-
2	6s	-
3	7s	-
4	8s	-
5	9s	-
6	10s	-
7	11s	-
8	12s	-
9	13s	-
10	14s	-

Similarly, you can fan delay times:

- Fixture 1 Thru 5 Time Time 5 Thru 10 Enter : fans the delay times of Fixtures 1 through 5 between 5 and 10 seconds.

For more on fanning, including fanning using the parameter wheels and in spreadsheet views, see *Fanning* (p.170).

13.4 Cue Wait Timing

In addition to manually pressing Go to execute you can also automate the triggering of a cue by assigning a wait value for the cue. The wait value for a cue is assigned in the wait column of the cuelist window. To assign how long a cue timing:

1. List 1 Open : open the cuelist.
2. Select the Wait cell for the desired cue, and press Set.
3. The Trigger Toolbar will appear below the Wait cell; see *Figure 13.10, "The Trigger Toolbar"*. Select an option from this.



Figure 13.10. The Trigger Toolbar

A cue's wait column options are:

- **Halt:** Does not allow the cue to be triggered automatically unless a timecode value later in the list causes the cue to be jumped. In all other cases the Go key must be manually pressed to execute this cue. Halt is shown by an empty Wait cell and it is the default wait column value for newly created cues.
- **Wait:** Triggers the cue after the specified time has passed from the triggering of the previous cue (either automatically or by pressing Go). It should not be confused with the Delay, which is the time between the cue being triggered (after a Wait if there is one) and the fade starting. The Wait time schedules cues within the cuelist, whereas the Delay time schedules the fades of each parameter within the cue. A cue can contain multiple Delay times, but it can only have one Wait time. See *Figure 13.1, "Cue timings"*.

A wait is displayed as the time value in the Wait cell.

- **Follow:** Triggers the cue once the previous cue has completed all its fade and delay times. You can enter a time after pressing the Follow button, which determines the time between the previous cue completing and the follow cue being triggered. See *Figure 13.1, "Cue timings"*.

The follow is displayed in the Cuelist window as 'Follow + [time]'.

The follow time should not be confused with the wait time. The follow time controls the time between the end of one cue and the triggering of the next, while the wait time controls the time between the triggering of one cue and the triggering of the next.

- **Timecode:** Triggers the cue when the specified timecode value is received. See *MIDI timecode* (p.378). The timecode value will be displayed in the wait cell.
- **Manual:** A manual cue can only be triggered by pressing the Go key. This means the cuelist will stop until the Go key is pressed, irrespective of any wait, follow or timecode triggers that later cues in the list may have.

Manual cues are useful because the word 'Manual' appears in the Cuelist window to remind the operator that they need to press the Go key. They are also useful to prevent times being recorded into the Wait column when using *Learn Timing* (p.250).

- **Clock:** Triggers the cue when the specified real-world time and date is reached on the Hog 4 OS built in clock; see *Clock Triggers* (p.251).

13.4.1 Learn Timing

Learn Timing allows you to assign a cue's wait time value by manual executing the cues with the Go key when the learn timing option is selected for the cuelist. If a timecode clock assigned to that list is running when learn timing is enabled then the wait value recorded into the wait cell will be a timecode value.

To use Learn Timing with timecode:

1. Open, Choose : open the Cuelist window of the required cuelist.
2. Options → Cuelist Options : open the Cuelist pane of the Cuelist Options window.
3. Select Enable Timecode, and choose a timecode source. Close the Options window.
4. In the Cuelist window, click View Timecode. The Timecode Toolbar will open.
5. If your timecode source is not currently running, click Simulate on the Timecode Toolbar to have the console create a timecode source. Controls for the timecode will appear.
6. In the Cuelist window, select Learn Timing.
7. Start the timecode, and press the Go key when the timecode reaches the time that you want each cue to go. A timecode frame value will appear in the Wait cell for each cue.
8. When you have finished, deselect Learn Timing.

Now when you run the timecode, the cues will be triggered when the timecode reaches each cue's assigned frame. For more information on timecode, see *MIDI timecode* (p.378).

To use Learn Timing without timecode:

1. Open, Choose : open the Cuelist window of the required cuelist.
2. Ensure that Enable Timecode is not selected.
3. Select Learn Timing.
4. Press the Go key to run the first cue, and again to run subsequent cues after the required time interval. A time value equivalent to the duration between Go presses will appear in the Wait cell for each cue.
5. When you have finished, deselect Learn Timing.

Now when you run the first cue, the subsequent cues will be triggered at the same intervals as when you ran them manually.



Tip

Learn Timing will only set a trigger on a cue that is currently set to Halt - that is, it has an empty Wait cell. To remove existing wait times from cues, select the wait cell(s) and press Set. Select Halt from the toolbar.

13.4.2 Clock Triggers

To assign a cue to be triggered at a particular time and date using Hog 4 OS's internal clock:

1. List 1 Open : open the cuelist.
2. Select the Wait cell for the desired cue, and press Set.
3. The Trigger Toolbar will appear below the Wait cell; see *Figure 13.10, "The Trigger Toolbar"*.
4. Select Clock; the Clock Trigger window will open:

Clock Trigger

Start Time: 4 20 0 PM

Start Date: 27 September 2012

Recurrence Pattern

Time

Daily

Weekly Every (h:m:s) 0 0 0

Monthly

Yearly

OK Cancel

Next date/time for this trigger: 27/09/12 4:20:00 PM

5. Adjust the Start Time and Start Date to assign a single shot trigger.
6. If you want the trigger to recur at regular intervals, check the Recurrence Pattern check box. Then click the frequency (Time, Daily, Weekly, Monthly, Yearly) with which you want the trigger to recur, and select options for the specified frequency.

**Tip**

The next valid trigger date and time is shown at the bottom of the Clock Trigger window.

7. Click OK.

Once you have set a clock trigger, the cuelist window will now indicate the trigger time and type in the cue's Wait column:

Number	Wait	Name	Mark	Comment	Fade	Delay	Path	Macros
1	-> 4:20:00 AM	Cue 1			2s,10s,15s,0s	-	-	
2	3:27:19 PM H	Cue 2			2s,10s,15s,0s	-	-	
3	4:37:00 PM H	Cue 3			2s,10s,15s,0s	-	-	
4	5:30:00 PM H	Cue 4			2s,10s,15s,0s	-	-	
5	7:13:13 PM H	Cue 5			2s,10s,15s,0s	-	-	
End								

To enable or disable the clock functions on a cuelist, toggle the Enable Clock button in the cuelist window:

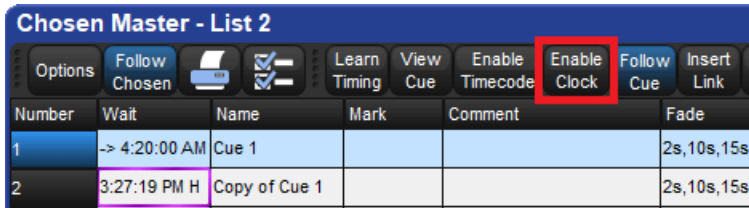

Tip

You can also enable or disable the clock functions for a cuelist in the Cuelist Cuelist Options window, or using macros; see *Macros* (p.399).

Clock Recurrence Patterns

Clock triggers can be programmed to trigger on a regularly scheduled interval such as every hour, day, or week based on the provided start time of the trigger and selected recurrence pattern. To set a recurrence pattern for a clock trigger check the Recurrence Pattern check box. Then select the frequency (Time, Daily, Weekly, Monthly, Yearly) for which the trigger should recur. A set of more complex options are then provided to further customize the recurrence pattern.

For daily triggers, a recurrence value of "every 0 days" nullifies the recurrence pattern and thus the clock trigger will only fire once on the start time specified.

For weekly triggers, a recurrence value of "every 0 weeks" indicates that the clock trigger will fire on the days specified but only for the upcoming week. For example, a weekly pattern value of "every 0 weeks" with the Monday and Tuesday options checked will fire the clock trigger on the upcoming Monday and Tuesday and then stop recurring.

The Clock Toolbar

The Clock Toolbar shows the time and date according to the Hog 4 OS clock, and information about the next cue due to be triggered. To open the Clock Toolbar:

- Open + Clock : the Clock Toolbar will open on the left touchscreen:



The Clock Toolbar will automatically update its fields according to the next valid trigger.



Tip

You can assign the format of the date and time in the Appearance pane of the Preferences window. The Clock Toolbar, Cuelist triggers and the Command Line Toolbar clock will display in the selected format.

13.5 Loops and Links

Normally cues in a cuelist will be replayed in numerical order, but you can use links to change this. Links can be used to jump to other points in the cuelist, or to create loops.

Unlike some consoles, Hog 4 OS creates a link as a special type of cue, rather than an attribute of an ordinary cue. Because it is a separate item in the cuelist, you can move cues within the list without disturbing the link.



Tip

When a cuelist gets to the end, it will link back to the first cue by default, so there is no need to put a link in.

13.5.1 Creating a Link

To create a link:

1. Open + (Cuelist 1) : open the cuelist window.
2. Play the cues in the list until the current cue (shown by -> in the wait column) is the cue before where you want the link.
3. Click on the Insert Link button in the window. The link cue will be inserted after the current cue.
4. Select the Fade cell of the link.
5. Set [**cue number**] Enter : assign the cue number to be linked to.

You can delete link cues in the same way as any other type of cue. For example:

- Cue 3.5 Delete

13.5.2 Creating a Loop

To create a loop, you need to have two things:

- A link that points to a cue earlier in the cuelist.
- All the cues in the loop (between the linked-to cue and the link cue) must be assigned with wait or follow triggers; see *Cue Wait Timing* (p.249).

Hog 4 OS will recognise this as a loop; see *Figure 13.11, "A Cuelist with a Loop"*.

Chosen Master - List 2									
Number	Wait	Name	Mark	Comment	Fade	Delay	Path	Macros	
1	->	Cue 1				2s	0s	-	
1.1	1s	Cue 1.1				2s	0s	-	
1.2	1s	Cue 1.2				2s	0s	-	
1.3	1s	Cue 1.3				2s	0s	-	
1.8	1s	Cue 1.8				2s	0s	-	
1.9	1s	Link			Cue 1	Forever			
2		Cue 2				2s	0s	-	
End									

Figure 13.11. A Cuelist with a Loop

Exiting Loops

You can determine when the cuelist stops looping and continues with cues after the loop. The options are:

- **Forever:** the loop will run indefinitely until you press the Go key.
- **Count:** the cuelist will loop the assigned number of times. Assigning a count of zero will make the cuelist ignore the link.
- **Timed:** the cuelist will loop until the assigned time period has elapsed.

To assign the looping behaviour:

1. Open + (Cuelist 1) : open the cuelist window.
2. Select the link cue's Delay cell, and press Set.
3. Select an option from the Loops Toolbar:

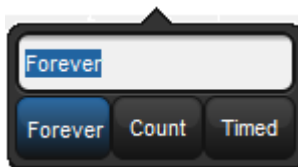

4. If you have selected Count or Timed, enter a count or timed value.

You can also configure what happens when you press the Go key during a loop; see *Action of go when Looping (p.306)*.

13.5.3 Tracking Through Loops

By default, Hog 4 OS's feature ensures that, when you use links to change the order of cue playback, the cues appear on stage as if they had been played back in the order they appear in the cuelist.

Sometimes, however, you might want to track through links rather than maintain state. For example, you are creating a loop where the first time through you want the four fixtures to come on one at a time, and throughout the loop you want them to alternate colour between red and blue. To do this, you might plot:

Cue	Fixture 1		Fixture 2		Fixture 3		Fixture 4	
	Int.	Colour	Int.	Colour	Int.	Colour	Int.	Colour
1	50%	Red		Blue		Red		Blue
2	↓	Blue	50%	Red		Blue		Red
3	↓	Red	↓	Blue	50%	Red		Blue
4	↓	Blue	↓	Red	↓	Blue	50%	Red
5	Link to Cue 1							

The idea is that the intensity of the next fixture is brought to 50% in each cue, and that these values then track through for the duration of the loop (shown by the arrows). However, because of the Maintain State function, when the cuelist loops back to cue 1 Hog 4 OS will make cue 1 look as it would have if you had run the cuelist in order. The result is that fixtures 2 to 4 will go out, just as they were the first time round the loop.

To stop this happening, you need to enable Track Through Loops, in the Cuelist Options window:

1. Open List 1 : open the cuelist window.
2. Press Options and select the Track Through Loops tick box.

Note that Track Through Loops also applies when the cuelist automatically loops back to the start of the list after you play back the last cue in the list.



Important

The Track Through Loops option applies to the whole cuelist. Using it may have unintended consequences when playing back other cues in the cuelist out of sequence.

Section 14: Effects

14.1 Table Effects

Effects can be used to create a repeating change or ‘movement’ in the value of fixture parameters. Effects are recorded as part of cues, scenes and palettes.

Table effects are effects applied to fixture functions using wave tables that apply mathematical functions (such as sine or tangent) to values against time. Table effects have seven main attributes: table, size, rate, offset, length, bounce, direction, and sync. Each effect table also has its own timing parameters for fade, delay, and path.

There are three ways to apply table effects to a fixture selection:

Predefined Effect Palettes: A range of pre-programmed effects can be found in the effects directory window that can be quickly applied and then tweaked if desired

The Effects Engine: A special editor window where users can assign and edit the effects values for the current fixture selection.

Using the Programmer / Cue Editors: You can assign and edit effects values for specific fixture in editors such as the programmer just as you do with other values.

14.1.1 Effect Tables

One of the main components of a table effect is the effect table itself, which applies a mathematical function (such as sine or tangent) to the parameter values. The available tables, and how the parameter value varies over time, are shown in *Figure 14.1, “Effect Tables”*.

Note that the effects table varies the value of the parameter either side of its base level, represented by the dotted line in the diagrams. The three types of random table are weighted differently, biasing the random parameter values towards the low, high or middle part of the possible range.

Using Effect Tables

Listed below are examples of combinations of effects tables in use:

- **Circular Motion:** A Sine table is applied to pan and tilt, with tilt given an Offset of 90 degrees.
- **Square Motion:** A Sawtooth table is applied to pan and tilt, with tilt given an Offset of 90 degrees.
- **Can-Can Motion:** A Step table is applied to pan, a Sine table is applied to tilt.













Sine		Tangent		Step	
Sawtooth		Ramp		Inverse Ramp	
Mark On		Mark Off		Spiral	
Random 1 Low-weighted		Random 2 High-weighted		Random 3 Centre-weighted	

Figure 14.1. Effect Tables

- **Fly In Motion:** A Step table is applied to pan, a Ramp table is applied to tilt.
- **Blue Step Colour Effect:** A Mark On table is applied to cyan and magenta.
- **Iris Chase:** A Sawtooth table is applied to the iris.

**Tip**

You can create many of these useful combinations of tables using the predefined effects palettes; see *Predefined Effect Palettes* (p.266).

14.1.2 Table Effect Attributes

The appearance of the effect table through a combination of adjustments to its attributes: rate, size, offset, begin, end, start, length, direction, bounce, and N-shot.

Effect Rate

The effect rate controls the speed of the effect in cycles per minute.

Adjusting an effect's rate will increase or decrease the number of cycles it completes per minute. When combining effects, you can use the rate attribute to build a specific look. For example, if you create an effect where a fixture performs a circular motion fading in on the first circuit, out on the second, then the effect on the intensity parameter would need to be half of the rate on the position parameters.

The following diagram shows how the value of a parameter assigned to the sawtooth table changes over time, with different rate values:

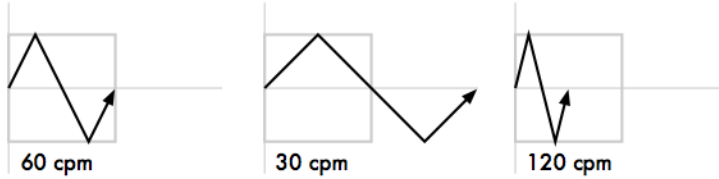

Effect Size

The range over which the parameter value varies. This is described in terms appropriate for the parameter, for example degrees for position parameters, or slots for slotted colour parameters.

For example, applying a Sine wave with the default size of 5Hz to a base value strobe rate of 5Hz will vary it from 0Hz through to 10Hz. You can decrease this range by adjusting the size: 2Hz will give a range between 3Hz and 7Hz.

When combining effects, adjusting specific parameters' effect sizes will change the look of the effect. For example, a circle effect comprising of a sine table on the pan and tilt can be modified to look like an ellipse by altering the size of either pan or tilt.

The following diagram shows how the value of a parameter assigned to the sawtooth table changes over time, with different size values:

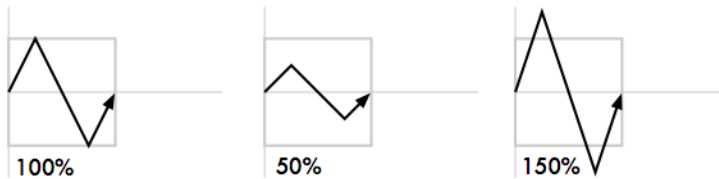

Effect Offset

The offset sets the effect start and finish point for each effect, so they can be staggered. It is assigned in degrees.

For example, to create an intensity ripple across a range of fixtures, divide 360 degrees by the number of fixtures and offset each fixture by multiples of this amount. For example, with six fixtures offset at 0, 60, 120, 180, 240, 300 degrees. The easiest way to do this is to use fanning; see *Fanning* (p.170).

The following diagram shows how the value of a parameter assigned to the sawtooth table changes over time, with different offset values:

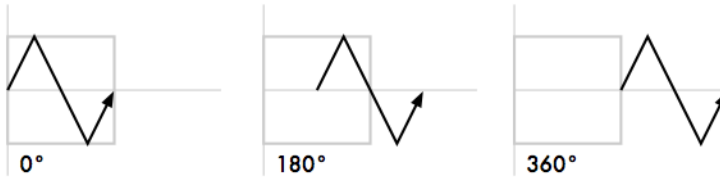

Effect Begin , End, Start

The begin and end values of an effect represent the limits that the function value will hit as it passes through the effect table. The begin and end values can be edited directly in the effects editor window or in the programmer / cue editor. Be aware that editing the begin and end values of an effect result in an adjustment to the base value for that fixture function as well.

The start value of an effect is the real world value at which the function will start the effect. The start value of an effect is directly tied to the offset value of an effect.

The following diagram shows the begin, end, and start points of a simple effect:

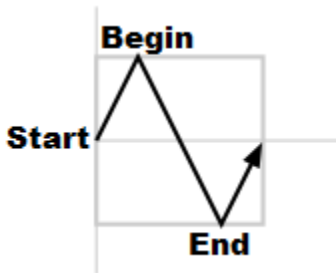

Effect Length

The length is the proportion of the effect's period that it is active for. It is assigned as a percentage.

The following diagram shows how the value of a parameter assigned to the sawtooth table changes over time, with different length values:

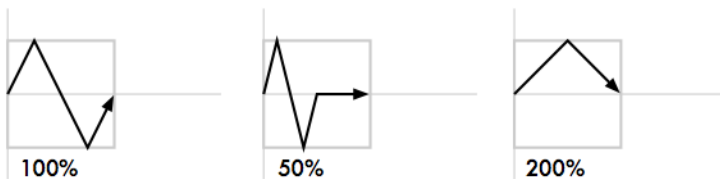

N Shot

This is the number of times that the effect repeats before finishing. A dash (—) in the N Shot cell denotes that the effect will run indefinitely.

Bounce

When bounce is enabled for an effect the fixture function will run one direction through the effect cycle and then reverse direction to run through the cycle in the opposite direction and will continue to alternate the direction in which it runs through the cycle.

Direction

The direction of an effect determines whether the selected wave table will be applied to the function in a forward or reverse direction.

Sync

Allows users to synchronize the timing of effects across fixtures and/or across parameters within and throughout different playbacks. For example, using the global sync option for all effects in a show will ensure that the effects in the show will always look the same no matter how or when its cues/scenes are played back.

14.1.3 Building Table Effects in the Effects Engine

To apply an effect:

1. In the Programmer or editor, select the required fixtures and assign their base parameter values. These settings will be the 'underlying' state for the effect: for example, the center position of a fixture doing a circular movement effect. Equally, an intensity ripple between 0-100% will need a base value of 50% in order to use the full length of the effect.
2. Open + Effect : the Effects Engine and Effect Directory will open.
3. In the Effects Engine, select the Table cells for the fixture parameters that you want to apply the effect to.
4. Press Set, choose the effect table from the menu and press Enter.

Effects Engine															
Function	Layer 1														
	Table	Rate	Size	Offset	Begin	End	Start	Length	N Shot	Bounce	Direction	Sync	Fade	Delay	Path
ALL		45.5bpm	82°	0°	-82°	82°	0°	100%	-	Off	Forward	Function & Fixture	2s	0s	Default
All Intensity															
All Position		45.5bpm	82°	0°	-82°	82°	0°	100%	-	Off	Forward	Function & Fixture	2s	0s	Default
All Colour															
All Beam															
Intensity															
Strobe															
Fan	Sine	45.5bpm	82°	0°	-82°	82°	0°	100%	-	Off	Forward	Function & Fixture	2s	0s	Default
Tilt	Sine	45.5bpm	82°	0°	-82°	82°	0°	100%	-	Off	Forward	Function & Fixture	2s	0s	Default
Cyan															

Figure 14.2. The Effects Engine

Once the effect table is assigned, you can modify the effect attributes either by editing the values in the spreadsheet or using the parameter wheels when the Effect key is selected.

**Tip**

You can quickly edit the attributes of all one parameter type (All Intensity, All Position, All Colour, All Beam) or for all parameters within the top five rows of the Effects Engine.

To edit the values in the spreadsheet:

1. Select the cells for the parameters that you want to edit, and press Set.
2. Type a new value, and press Enter.

Or, using the parameter wheels:

1. Press the Effect key.
2. Select the individual parameters that you want to edit in the left hand Function column of the Effects Engine window.
3. Adjust the Size, Rate, Offset and Length parameter wheels as required.

Note that the parameter wheels only control the current effects row, selected using the buttons in the Function column. There are buttons for all parameter types, for all intensity, all colour, all position, all beam, and for each individual parameter type.

**Tip**

All effect attributes can be fanned using the Fan key and parameter wheels; remember to select the required parameter types in the Effects Engine Function column first. You can also enter a value of, say, 50 Thru 80 in a cell of the Effects Engine window. See *Fanning* (p. 170).

14.1.4 Building Table Effects in Editors

Effects can be assigned directly to specific fixtures and their attributes in any editor including the Programmer. This is helpful when you wish to make small changes without opening the Effects Engine. Effect types are assigned and edited in the Table view, whilst effect attributes can be adjusted in the Size, Rate, Offset, Length, Table and N Shot views. The views are selected by buttons at the top of the Programmer or editor window.

For example, to create an offset circle effect using fixtures in positions from the current onstage look:

1. Main Toolbar → Programmer : open the Programmer.
2. **1 Thru 5** Position Suck : sucks position information from fixtures 1 through 5 that are currently live on stage.
3. Table : select the Table view in the Programmer; the pan and tilt column will read (Off).
4. Select all pan and tilt cells of the selected fixtures by clicking and dragging.
5. Set → Sine, Enter : choose the Sine table from the drop-down menu and confirm by pressing Enter.
6. Select Offset : select the Offset view in the Programmer; the pan and tilt column will read (0-Deg).
7. Select all pan and tilt cells of the selected fixtures by clicking and dragging.
8. Set **1 Thru 288** Enter : offset pan and tilt equally across the fixtures.

Once you have applied an effect to a parameter, it will appear in the Value view of the Programmer or editor with the effects symbol next to the value:

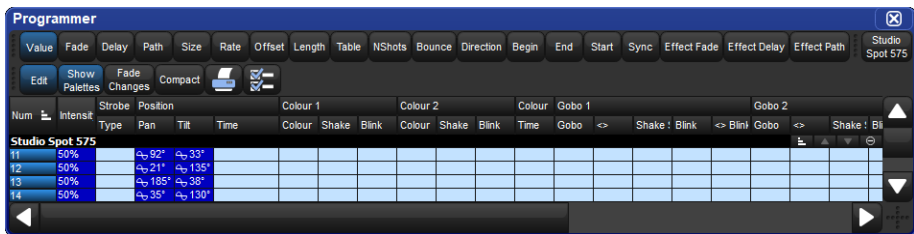

Tip

When assigning effect parameters such as Offset, remember that values 0 and 360 Degrees are the same. Fanning a range of fixtures from 0 through to 360 degrees of offset will mean that the first and last fixtures will share the same offset value.

14.1.5 Effect Spread

Effect Spread is an offset control mechanism that appears on the 5th encoder wheel of Hog 4 and Full Boar 4 consoles and on the second encoder wheel page of all other consoles when the effect kind is selected. The effect spread is a simple way to spread the effect offset evenly among the selected fixtures. For example, an effect spread of 100% evenly distributes the effect offset values for the currently selected fixtures from 0 to 360 degrees so that every fixture within the selection has a unique offset. The effect spread value is not stored in cues, scenes or palettes. Instead the effect spread is treated as a front-end tool to establish individual offsets among selected fixtures. The effect spread value is cleared following any changes to the individual fixture's offset values and/or any changes made to the fixture selection. Effect spread is not shown in editor windows or the effect engine as it is only a manipulation control of the offset values for effects. To achieve a negative effect spread hold the minus key while turning the effect spread encoder to the left. Switching between a negative effect spread and a positive effect spread reverses the perceived direction of the effect from fixture to fixture.

14.1.6 Building Table Effects using Palettes

Effects can also be built using two palettes and the correct command line syntax. This is helpful when you wish to make an effect that is bound by the values stored in two specific palettes. The syntax for building an effect between two palettes is `Effect @ [Palette] thru [Palette]`. When performing this syntax the console will construct a 5 bpm sine wave effect between the two palettes in the effect editor for the selected fixtures.

For example, to create an effect between position palette 1 and position palette 2:

1. Make a fixture selection (ensure the fixture selection consists of fixtures that have values stored in position palettes 1 and 2)
2. `Effect @ Position 1 thru Position 2 Enter`



Important

The palettes used to build table effects are not referenced in the effect. Therefore, once the effect is recorded into a cue, scene, or palette any references to the original palettes used to build the effect are lost.

14.1.7 Tracking Table Effects

By default, effects values track through to subsequent cues until a new value for the particular parameter is reached. You can turn effects on and off, set them to track through in the Table column of the Effects Engine, Programmer or editor.

In the Programmer for example:

1. Select Table view.
2. Select the cell of the parameter for which you want to turn the effect off or allow to track through, and press Set.
3. Select Off or Track from the drop down menu.

14.1.8 Cue Timing and Table Effects

When you record a cue, scene or palette that includes effects values, each fixture parameter has its fade, delay and path value in the usual way; see *Individual Parameter Timings* (p.243). These timings control how the fixture parameter changes from its starting value to its *underlying* value in the cue or scene, as the cue or scene is played back.

You can assign separate effects timings (fade, delay and path) to control how the effects movement changes as the cue or scene is played back. Figure 14.3, “Controlling Effect Transitions with Timing” shows how different timing values control how a parameter with a step effect changes during playback of a cue.

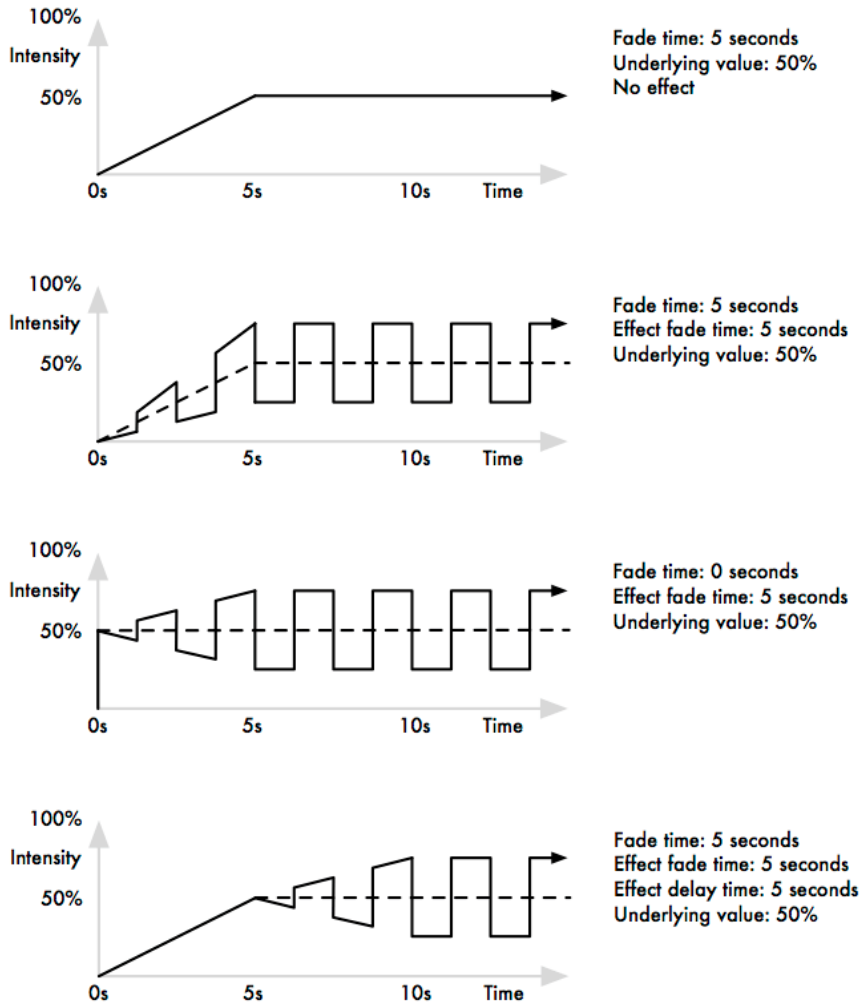

Figure 14.3. Controlling Effect Transitions with Timing

You can assign effect fade times using the command line:

1. Fixture **1** : select the fixtures you want to assign an effect time to, making sure that they have been given parameter values.
2. Effect Time **4**, Enter : assigns the effect fade time to 4 seconds.

To assign a effect delay time:

1. Fixture **1** : select the desired fixture(s).
2. Effect Time Time **2**, Enter : pressing Time twice assigns the delay time.

You can also view and assign effect timing values in the Effects Engine window:

Effect Timings

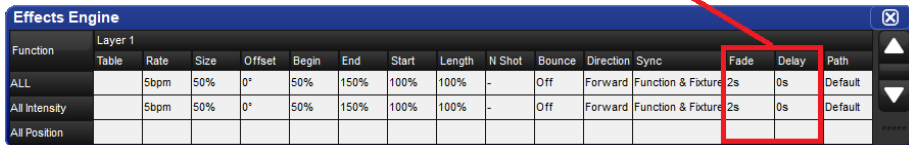

Function	Layer 1													Path	
	Table	Rate	Size	Offset	Begin	End	Start	Length	N Shot	Bounce	Direction	Sync	Fade		Delay
ALL		5bpm	50%	0°	50%	150%	100%	100%	-	Off	Forward	Function & Fixture	2s	0s	Default
All Intensity		5bpm	50%	0°	50%	150%	100%	100%	-	Off	Forward	Function & Fixture	2s	0s	Default
All Position															

14.2 Effect Palettes

14.2.1 Predefined Effect Palettes

You can quickly apply effects to the current selection using predefined effects palettes in the Effect Directory; see *Figure 14.4, "The Effect Directory"*. Effects palettes for parameter functions not available in the current selection will be greyed out; for example the Iris Step palette is not available for Studio Color 575s as they do not have an iris parameter.

To open the Effect Directory:

- Open + Effect

Or:

- Effect, Effect

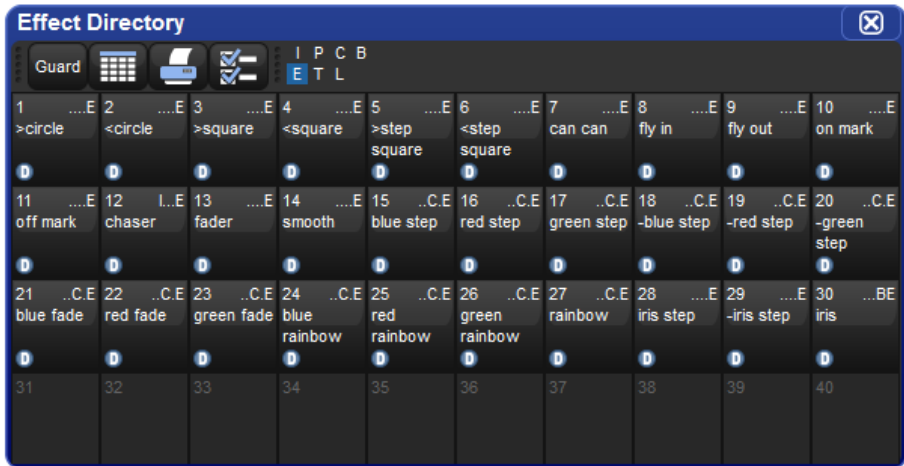

Figure 14.4. The Effect Directory

To apply an effects palette:

1. **1 Thru 5 @ 50 Enter** : select the required fixtures and assign an intensity value
2. **Effect 13 Enter** : assigns Effect Palette 13. Studio Colors 1 to 5 fade their intensity between 0 and 100%.

You can also select the effect palette by pressing or clicking on its button in the Effect Directory window.

14.2.2 Adjusting Predefined Effects

Once you have applied a predefined effects palette to the selected fixtures, you can alter the attributes (Rate, Size, Offset and Length) of the effect using the parameter wheels; for explanations of the different attributes, see *Table Effect Attributes (p.258)*. The Wheels Toolbar shows the current parameter value being assigned by each wheel whenever the Effect key is selected; see *Figure 14.5, "The Wheels Toolbar showing Effect Attributes"*. For more on the different effect attributes see *Table Effect Attributes (p.258)*.



Figure 14.5. The Wheels Toolbar showing Effect Attributes

14.2.3 Recording an Effect Palette

You can record any combination of effect parameter values into a palette:

1. In the Programmer or editor, select the fixtures, and assign the required effects. You can do this directly in an editor or using the Effects Engine.

2. Record, Effect : the Effect Directory window opens.
3. Select a location by pressing a button in the directory window.

This will only record parameters that have been **touched** in the Effect window, and does not include the parameters' underlying values. To include underlying intensity, position, colour, beam and time information use the **mask** function:

1. Select the fixtures, and assign the desired effect table.
2. Record, Effect
3. Select Mask from the Record Options Toolbar, and select the parameter types that you wish to record: Use I for intensity, Use P for position, Use C for colour, Use B for beam, and Use T for time values.

For more on masking when recording palettes, see *Recording Palettes with Kind Masking* (p.187).

4. Select a location from the Effect Directory window.

Naming an Effect Palette

You can give an effect palette a name that will be displayed in the Effect Directory:

1. Open + Effect : opens the Effect Directory.
2. Check that the Guard button is selected, so that you don't accidentally activate a palette when pressing its button in the directory.
3. Select the palette to be named.
4. Set [**name**] Enter : type in the name.



Tip

To name an effect palette immediately after recording it, pressing the Set key will open a Quickname window. Enter the palette name and select OK.

14.2.4 Using Effect Palettes in Programming

In the Programmer or editor, you can apply an effect by selecting it from the Effect Directory. The effect will be applied to the current fixture selection, providing that it contains parameter information for the selected fixtures. An iris step effect cannot therefore be applied to a fixture that has no iris function. By default, predefined effect palettes are direct; see *Direct Palettes* (p.190).

For example:

1. Open + Effect : open the Effect Directory window.
2. **1 Thru 5** : select the fixtures.
3. (Effect 1) : select the effect from the Effect Directory window.

Or, using the command line:

- 1 Thru 5 Effect 1 Enter

14.2.5 Editing Effect Palettes

You can edit an effect palette by opening it in an editor window; you can then edit its contents in the same way as you edit values in any editor. See *Building Table Effects in Editors* (p.263).

To open an effect in an editor:

1. Open + Effect : open the Effect Directory.
2. Open + (Effect 1) : open the editor for (Effect 1).

You can select the editor view (Table, Size, Rate, Offset, Length, N Shot) you wish to edit in. Also ensure that the editor is active with its Edit button selected.

You can also open an effects palette with the command line. For example:

- Effect 1 Open

14.2.6 Deleting Effect Palettes

To delete an effect palette using the command line:

1. Effect 1 Delete : deletes Effect Palette 1.
2. Click OK to confirm the delete.

Or, from the Effect Directory:

1. Press and hold Delete whilst selecting the palette to be deleted from directory.
2. Release the Delete key. A dialog will appear asking you to confirm the delete.
3. Click OK.



Tip

If you prefer not to be asked to confirm the delete action, select Don't Ask Me Again in the confirmation window. You can re-enable the confirmation by going to Setup → Preferences → Programming and selecting Confirm before deleting directory items.

14.2.7 Copying and Moving Effect Palettes

To make a copy of an effect palette in a new location:

- Effect **1** Copy; Effect; **2** Enter : copies the contents of Effect Palette 1 to Effect Palette 2.
- Effect; **1** Position; **2** Copy Effect **2** Enter : copies fixtures that are in Effect Palette 1 and in Position 2 into Effect Palette 2.

Similarly, to move an effect palette to a new location:

- Effect; **1** Move Effect; **2** Enter : moves the contents of Effect Palette 1 to Effect Palette 2, leaving 1 empty.

If the destination effect palette already exists, you will be asked to choose an option: *Insert, Merge and Replace (p.191)*.

Section 15: Kinds and Wheelsets

15.1 Kinds

Kinds are collections of fixture functions organized into wheelsets. The wheelsets determine how the fixture functions assigned to the kind will coordinate with the console's main encoder wheels when the kind is selected and a fixture selection is made. Kinds are stored in the kinds directory and exist in two different forms: fixed kinds and user kinds.

15.1.1 Fixed Kinds

Fixed kinds are automatically generated by the console and collectively contain all of the fixture functions used in your show. Every function of every fixture scheduled in your show will exist in one of the seven fixed kinds: Intensity, Position, Colour, Beam, Effects, Time, or Control. The fixed kinds can be selected using dedicated front panel keys or by clicking on their respective buttons in the kinds directory. The kinds directory can be opened by holding **Open** and then selecting **Kinds** from the main toolbar at the bottom of the right hand screen.

When a new fixture type is added to a show through the fixture scheduler its functions are automatically populated in the fixed kinds and organized onto wheelsets based on a default master wheelset template established by the Hog 4 OS. Fixed kinds cannot be deleted or moved. This is why they are known as "fixed" kinds.

Functions that are marked with a lock icon on the wheelsets within a fixed kind cannot be deleted. This is because those functions are considered to be permanent residents of that fixed kind and are fundamental to the masking scheme of that fixed kind. However, you can add additional functions to a fixed kind if you wish. For example, you can add a colour mixing function such as **Cyan** to the fixed position kind if you desire. Be aware that any additional functions you add to a wheelset in a fixed kind will not function as part of that fixed kind's masking. The arrangement of the functions on the wheelsets within a fixed kind are completely customizable regardless of whether or not they are marked with a lock icon.

15.1.2 User Kinds

User kinds, unlike fixed kinds, are not automatically generated when adding fixtures to the show. User kinds are custom built by the user, allowing you to create smaller collections of fixture functions on fewer wheelsets.

User kinds are stored in the kinds directory and are also accessible using the 12 function keys on the front panel of the console (when the function keys are set to kind mode). To toggle the function keys between "Kind" mode and "Command" mode hold down **Pig** and press **Enter**. The mode of the function keys is displayed on the main toolbar. To open the kinds directory hold the **open** key and press the "kinds" button on the main



Figure 15.1. Fixed Kinds in the Kinds Directory

toolbar. Note: The user kind keys on the Road Hog 4 console do not have LCD displays. Once created, user kinds can be selected by pressing the coordinating function key on the front panel or by selecting the kind from the kinds directory when guard is turned off. If you create more than 12 user kinds the console will automatically change the last function key on the front panel to a next button. You can create as many user kinds as you want.

**Tip**

TIP: To quickly edit a user kind simply hold Open and press the user kind's button on the front panel.

Manually Creating User Kinds

To manually create a new user kind:

1. Open + Kinds opens the Kinds Directory Window.
2. Press Record and then press any empty cell in the Kinds Directory window.

Auto-generating User Kinds

You can auto-generate user kinds for your show by pressing the auto-kind button at the top of the kinds directory or fixture schedule window. Auto-generated user kinds are based on pre-defined families of functions established by the Hog 4 OS. For example, Cyan, Magenta, Yellow, Hue, and Saturation are all part of the colour mixing family as defined in the Hog 4 OS library model, therefore a fixture that features these functions would automatically generate a user kind containing CMY and HS functions.

Deleting Users Kinds

To delete a user kind:

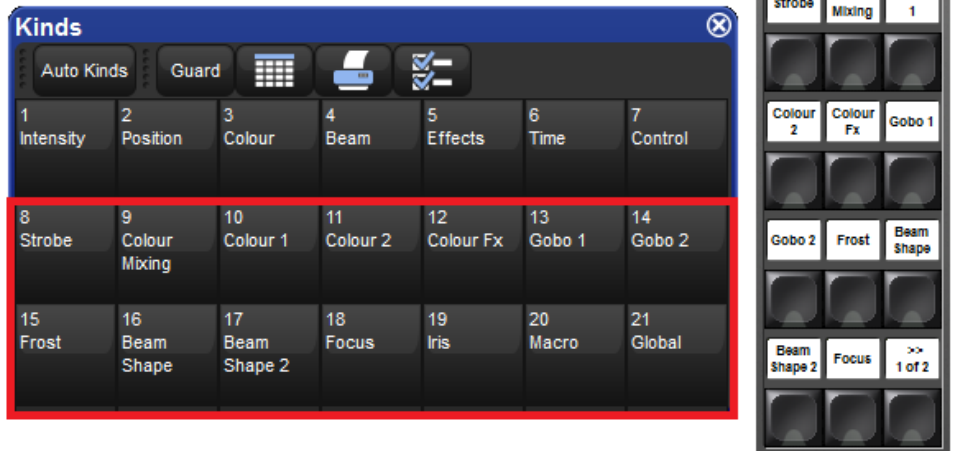

Figure 15.2. User Kinds as displayed in the Kinds Directory and on the Front Panel



Figure 15.3. Auto Kinds Button in the Kinds Directory

1. Open + Kinds opens the Kinds Directory Window.
2. Press and hold Delete and then press the cell of the kind you wish to delete in the Kinds Directory window.

Copying and Moving Users Kinds

To copy a user kind:

1. Open + Kinds opens the Kinds Directory Window.
2. Click on an existing user kind in the Kinds Directory, press the Copy key, and then click on any empty cell in the Kinds Directory window.

To move a user kind:

1. Open + Kinds opens the Kinds Directory Window.
 2. Click on an existing User Kind in the Kinds Directory, press Move and then click on any empty cell in the Kinds Directory window.
-

15.2 Wheelsets

Wheelsets are the building blocks of both fixed kinds and user kinds. They specify how fixture functions assigned within a kind are displayed on the console's main encoder wheels when a fixture selection is made.

Note: The center wheel located below the center touchscreen on the Hog 4 console's front panel is configured separately from the wheelsets established in the fixed or user kinds. For more information on the center wheel's function assignments: Center Wheel Preferences (p.99)

Every effort has been made by the developers of the Hog 4 OS to provide you with a logical wheelset arrangement by default but sometimes a re-arrangement of the functions within a wheelset or a re-arrangement of the wheelsets themselves is necessary. This section is intended to increase your understanding of how to manage the wheelsets in your show.

To access the wheelset for any particular fixed or user kind:

1. Open + Kinds opens the Kinds Directory Window.
2. Hold Open and click on any existing kind in the Kinds Directory

Within each kind editor are two main sections. On the left is a list of functions. On the right is a graphical interface showing sets of encoder wheels arranged in groups of five. Each one of these groups of encoder wheels is called a wheelset.

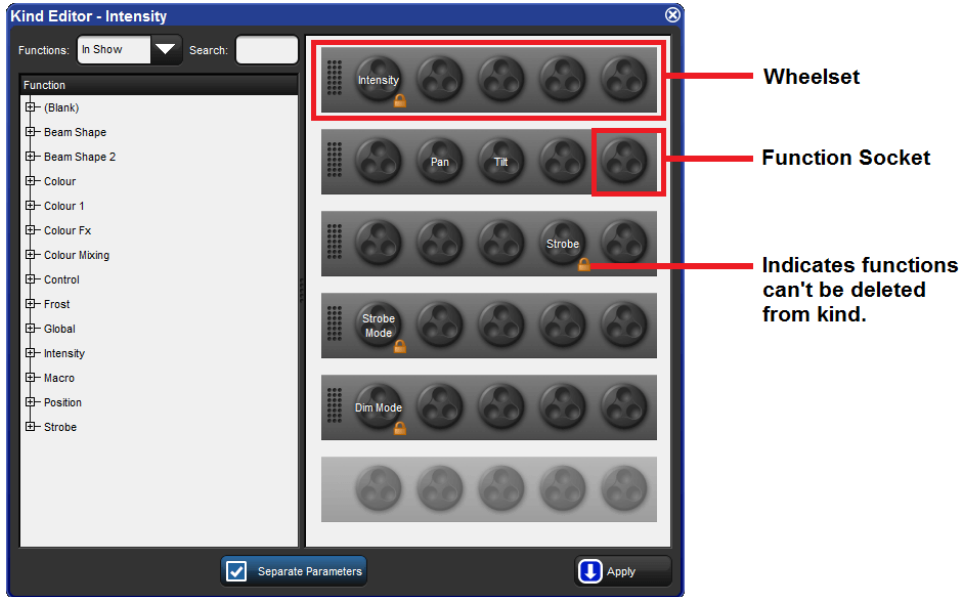

Figure 15.4. Wheelsets displayed in a kind editor

Wheels are holding places for fixture functions and coordinate with the encoders on the front panel. You will notice that several wheelsets can exist within a single kind editor.

To assign a function to a wheelset: Click and drag a function from the list of functions on the left hand side of the window to any wheel on one of the wheelsets.

To delete a function from a wheelset: Click on the function. It will highlight in blue. Press the backspace key on the front panel. The function will be deleted from the wheelset.

To add a wheelset: Click and drag a function from the list of functions on the left hand side of the window to wheel on the greyed out wheelset at the bottom of the right hand side side of window.

To delete an entire wheelset: Click anywhere on the wheelset's frame. The wheelset will highlight in blue. Press delete. The entire wheelset and its contained functions will be deleted.

To move a function on a wheelset: Click and drag the function you wish to move.



Tip

Functions marked with a lock icon and wheelsets containing functions marked with a lock icon cannot be deleted.

Section 16: Advanced Programming

16.1 Selecting from What is Onstage

You can select fixtures from what is on stage using the Live key. Fixtures are considered to be on stage if their intensities are non-zero. If you wish to select fixtures that are on-stage but have intensity values at zero then you can use Pig + Live.

Below are some examples of how live can be used:

- Live Enter : selects all fixtures that are on stage with intensities above 0.
- Pig + Live Enter : selects all fixtures that are on stage regardless of intensity.

You can apply a **mask** to the selection. This allows you to select all fixtures that are on-stage that are assigned to particular values or palettes. For example:

- Live @ 50 : selects fixtures that are on stage at 50%.
- Live @ 50 Thru 80 : selects fixtures that are on stage at 50% to 80%.
- Live @ 0 : selects fixtures that are at 0%.

Using a palette as a mask:

- Live (Blue) : selects fixtures that are on stage that are at their 'Blue' palette settings.

You can use the Live and / keys together to select fixtures that are both live on stage and in a specified fixture selection:

- Live 1 Thru 5 selects fixtures that are in the range 1 to 5 that are live on stage.
- Live / Group 1 selects fixtures that are in Group 1 that are live on stage.

Note that in all the above examples using the Live key only selects fixtures; it does not alter values in the Programmer or editor.



Tip

Fixtures that do not have an intensity parameter such as a colour scroller are always considered live on stage and will be selected when using the Live key.

16.2 Bringing Parameter Values Into the Programmer

Sometimes you will end up with a look onstage or in a cue, scene or palette that you want to reuse in further programming. There are various ways in which you can bring those fixtures and parameter values into the Programmer or editor.

16.2.1 Suck

You can use Suck to assign fixture parameters to the values that they currently have 'on stage'. It doesn't assign parameters that are at their **default value** which helps to prevent redundant values which can cause problems by blocking values that should track through. The Suck button is located on the Main Toolbar.

You need to have fixtures selected before using the Suck command. For example, if Group 3 contains Studio Color 575s 1 to 3:

- Group 3 Suck : assigns the fixtures in Group 3 to their current on stage values:

The top screenshot shows the 'Output' window with a table of fixture parameters for 'Studio Color 575' fixtures 1 through 6. The bottom screenshot shows the 'Programmer' window with a table of fixture parameters for 'Studio Color 575' fixtures 1 through 3, where the values are being updated from the 'Output' window.

Num	Intensity	Strobe Type	Position		Time	Colour Mixing					Co
			Pan	Tilt		Cyan	Magenta	Yellow	Hue	Saturatio	
1	100%	open	23°	-8°		0%	0%	0%	~	~	op
2	100%	open	20°	-34°		0%	0%	0%	~	~	op
3	100%	open	16°	-38°		0%	0%	0%	~	~	op
4	100%	open	56°	18°		0%	100%	100%	~	~	op
5	100%	open	69°	28°		0%	100%	100%	~	~	op
6	100%	open	0°	0°		0%	0%	0%	~	~	op

Num	Intensity	Strobe Type	Position		Cyan	Magenta	Yellow	Hue	Saturatio	Colour 1 Colour	Colour F:
			Pan	Tilt							
1	100%		23°	-8°							
2	100%		20°	-34°							
3	100%		16°	-38°							

Similarly, you can apply this to palettes, scenes and cues, using the Live key to bring in fixtures and their parameter values that are on stage:

- Live (Red Palette), Suck : fixtures on stage assigned to Red Palette are brought into the Programmer:

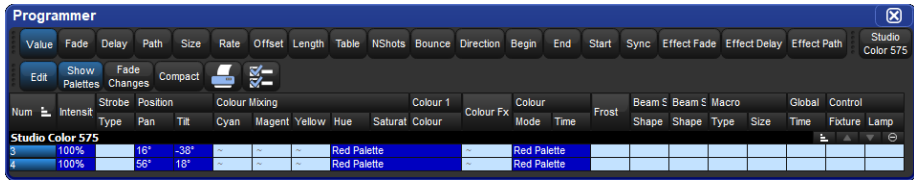

Or, you can use a mask to bring particular parameter type values from specific palettes that are on stage. For example, to bring the intensity values of (Red Palette) into the editor:

- Live (Red Palette), Intensity Suck : the intensity values of fixtures on stage assigned to Red Palette are brought into the Programmer:

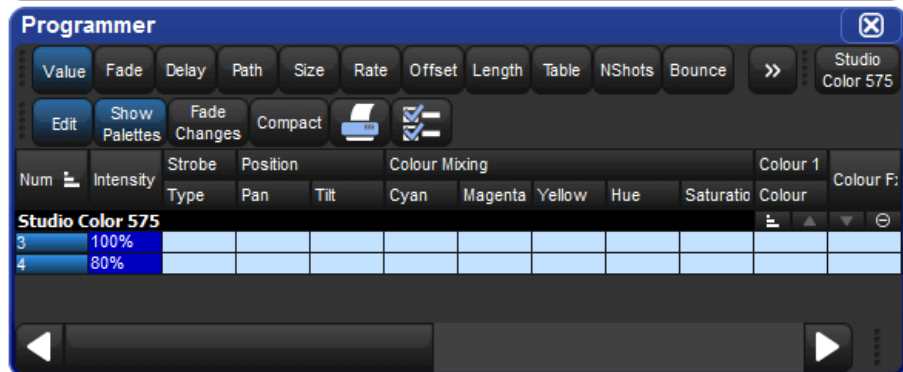
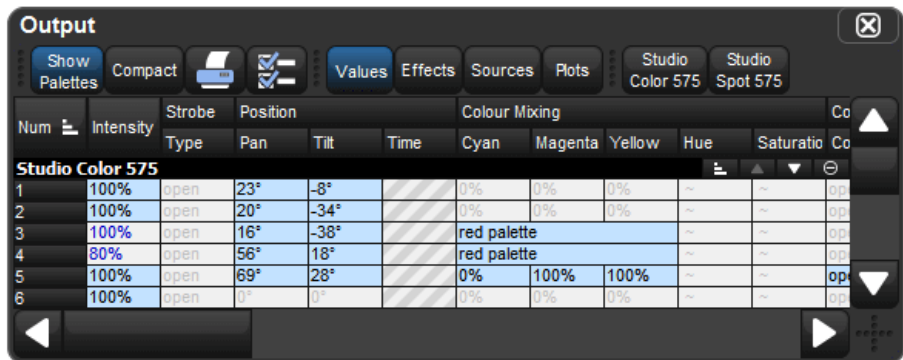

16.2.2 Using Live and Touch

Using Live and Touch together touches all parameters that belong to fixtures that are at non-zero intensity on stage, including parameters at their default values. This is similar

to suck, except that it will bring *all* values into the Programmer or editor, including those that are at their default values. The Touch button is located on the Main Toolbar.

For example, if Studio Color 575s 1 to 3 are in the output with an intensity of 100%:

- Live Touch : brings all the parameters of Studio Color 575s 1 to 3 into the Programmer, not just the intensity values (as suck would):

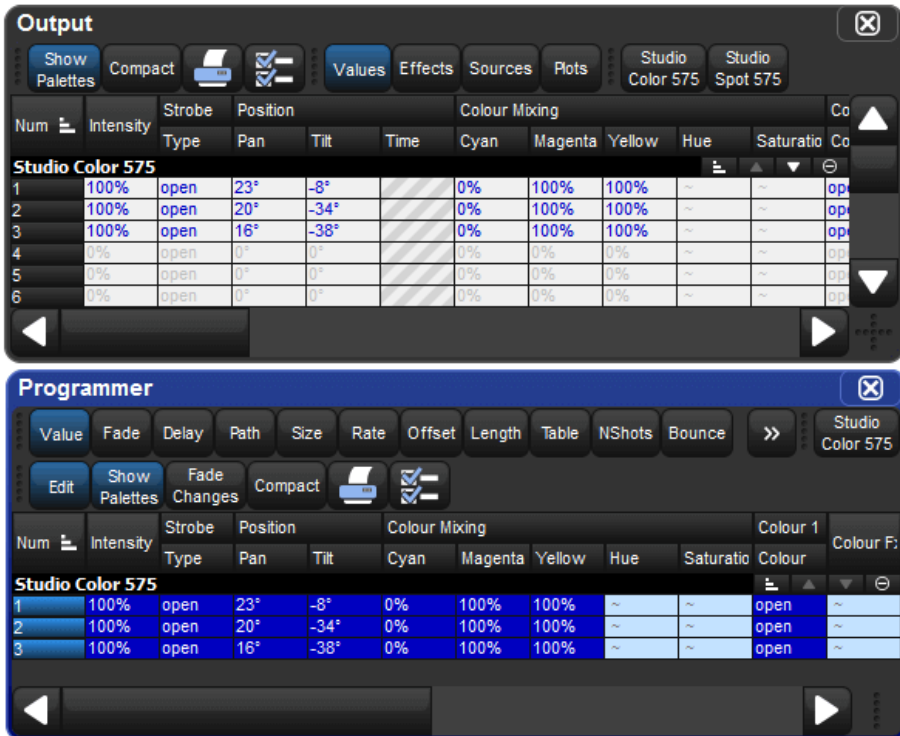

You can select the parameter types to touch:

- Live Colour Touch : only the colour parameters are touched:

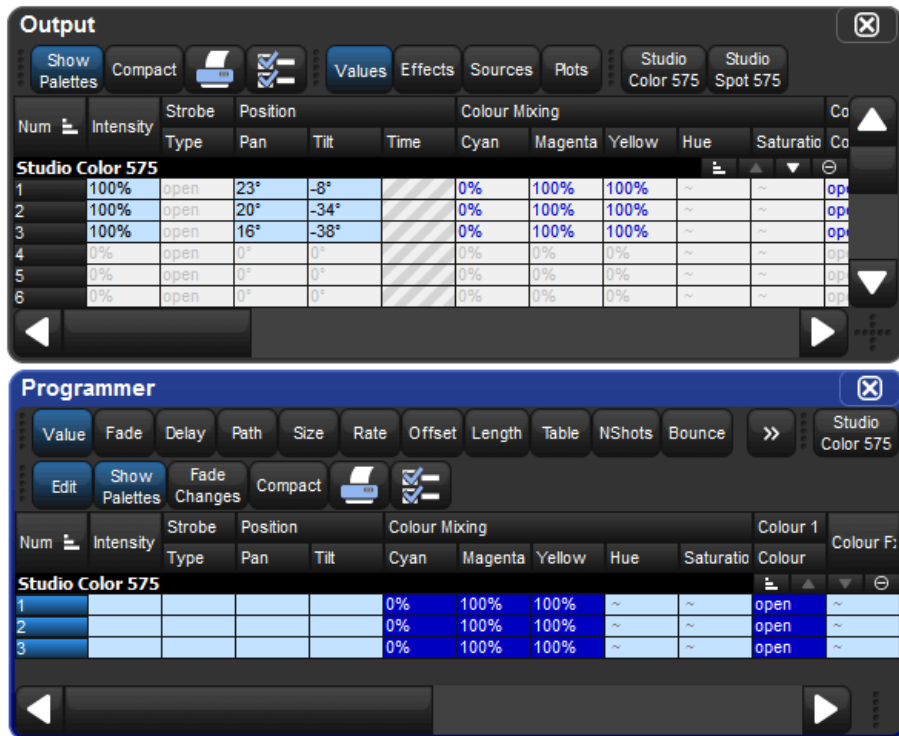

16.2.3 Using Copy to Bring Values into an Editor

You can bring parameter values from a palette, scene or cue into an editor such as the Programmer using Copy:

- Cue 1 Copy, Enter : copies the contents of Cue 1 of the currently chosen cuelist into the current editor.

You can chose which fixtures or parameter types are copied into the Programmer. For example:

- Cue 1 Position Copy, Enter : copies only the position values from Cue 1 into the current editor.

16.3 Highlight and Lowligh

Pressing the Highlight key temporarily adjusts the selected fixtures to 'open white', with intensity at full and all other parameters at their default settings. This function can be useful when you want to see the beam of a fixture on a lit stage, when assigning focus

positions for example. Highlight only changes the parameter values in the output, not in the current cue or in the Programmer or editor, and highlight has the highest priority when the console determines a parameter's output value.

Highlight will remain active until you press the Highlight key again, and you can use the Next and Back keys to highlight in turn each fixture in the current selection.

You can release each parameter from highlight by adjusting its value in the Programmer or editor, letting you modify parameters whilst keeping the fixture beam as visible as possible. For example, suppose that you have a Studio Spot 575 subtly lighting a part of the stage setting with a dark blue breakup gobo, softened using the frost parameter and with the iris controlling the beam size. The piece of set that the Studio Spot is lighting has been moved, and you need to refocus it while keeping the rest of the lighting state on stage so that rehearsals can continue. To do this using Highlight:

1. Select the Studio Spot in the Programmer.
2. Press the Highlight key. The Studio Spot will retain its position on stage, but the intensity will go to full, the colour to white, the gobo and frost to open, and the iris to 100%, so that you can see the beam clearly on the lit stage.
3. Adjust the pan and tilt parameters to position the Studio Spot as required.
4. Adjust the iris parameter to give the correct beam size.
5. Press the Highlight key again to release the colour, gobo and frost parameters from Highlight, so that they return to their original programmed values. The values for pan, tilt and iris retain their new values in the Programmer.
6. Press Update and OK to record the changes in the appropriate cue; see *Auto Update* (p.283).

16.3.1 Customising Highlight

By default, highlight brings intensity to full, with all colour and beam parameters at their default values. However, you can use a palette to assign the highlight values for each parameter of each fixture. This can be useful as the default highlight values for some parameters may not be what you want; for example, you may prefer to leave zoom, focus and iris settings unaltered by Highlight so that you can see the programmed beam size and edge quality.

To assign a pre-existing palette to be the highlight palette, right-click it in the palette directory and select it as the highlight palette. The highlight palette is shown by the



icon in the palette directory window.



Tip

You can use masking when creating the highlight palette to ensure that all the required parameter types are included; see *Recording Palettes with Kind Masking* (p. 187).

16.3.2 Lowlight

By default, the parameters of fixtures that are not selected when you use highlight remain at their current output values. You can customise the output values of these parameters during highlight by creating a lowlight palette. For example, you could create a lowlight palette that sets the intensity of all fixtures to 30%, to give the highlighted fixture greater contrast.

Note that lowlight only affects parameter values of the non-selected fixtures in the current editor. Parameter values being output by playbacks will not be affected.

To assign a pre-existing palette to be the lowlight palette, right-click it in the palette directory and select it as the lowlight palette. The lowlight palette is shown by the



icon in the palette directory window.



Tip

You can use masking when creating the lowlight palette to ensure that all the required parameter types are included; see *Recording Palettes with Kind Masking* (p. 187).

16.4 Auto Update

When you are programming a complex show, the look on stage may be built up from cuelists and scenes on several masters. You can change the look by assigning fixture parameter values in the Programmer, but it is difficult to know which cue or scene is contributing which values to the total on stage. Hog 4 OS's Auto Update feature automatically suggests the appropriate cues, palettes and scenes to merge the changes into, allowing you to choose how the updates are performed.

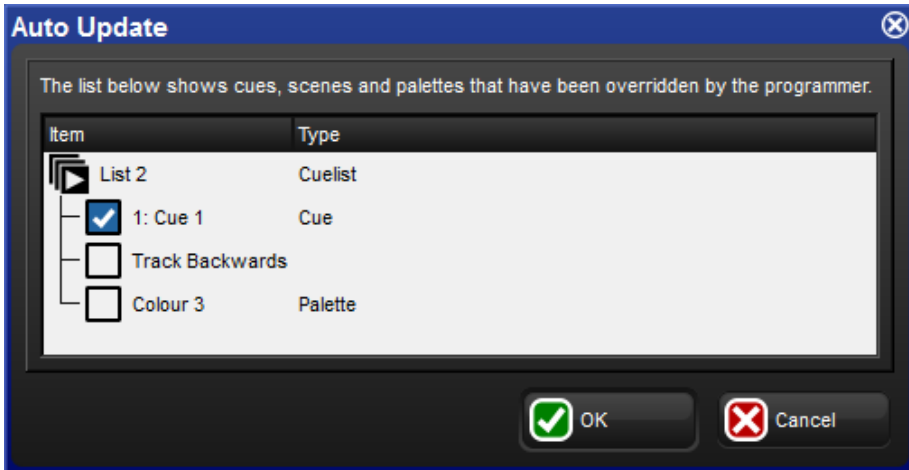

Figure 16.1. The Auto Update window

When you have finished editing in the Programmer you can merge the parameter values into the currently playing cues, palettes and scenes by pressing the Update key. The Auto Update window will open, showing which cuelists, cues, palettes and scenes are contributing to the look on stage so that you can choose which to update

For cuelists, you have several choices:

- Either update the current cue in the cuelist, or track the programming backwards so that the new values are merged into the last cue with a hard value for that parameter; see *Tracking Values Backwards When Recording* (p.219).
- If you have existing programming that refers to a palette, you can choose to update the palette instead of adding new parameter values to a cue. In this case, these updates will be performed first, and anything left in the Programmer after this will be used to update the selected cue or Track Backwards.

For scenes, you have the option to merge the programming into the scene, or into the palettes that are referred to in that scene.

Once you have chosen your options, press OK to perform the update. Note that the parameter values remain in the Programmer.

**Tip**

If there is no playback on stage when you press Update, the Auto Update window will not appear and the Update key press is ignored.

When you press the Update key, the Update Toolbar will also appear; see Figure 16.2, “The Update Toolbar”. This allows you to select which parameter types are updated, whether changes should track forwards, and whether references should be allowed

when updating palettes. See *Recording Palettes with Kind Masking* (p.187), *Stopping Values from Tracking Forward* (p.220) and *Reference Palettes* (p.190).



Figure 16.2. The Update Toolbar

16.5 Editing Discreetly

It is often useful to make changes to parameter values discreetly, or without them appearing on stage at all; during a rehearsal or performance for example. To do this, use Hog 4 OS's Fade Changes and Blind functions.

16.5.1 Fade Changes

If you select the Fade Changes button in an editor window, any changes you make will appear on stage over the current time settings for the changed parameters. For example, if you have intensity values in the Programmer with a fade time of ten seconds, and you select all of the fixtures and press @ 0 Enter, all of the lights would fade to 0 over 10 seconds. This is useful for making changes on the fly during a performance.

Parameters that don't have timing values in the Programmer will fade in the default time, which you can assign in the Default Timing pane of the User Preferences window:

- Setup → Preferences → Default Timing

Press the Fade Changes button again to revert to having parameter values appear in the output instantly.

To view and assign time values for parameters, see *Individual Parameter Timings* (p.243).



Tip

You can set a trackball key turn Fade Changes on and off; see *Trackball Keys* (p.97).

16.5.2 Blind

Blind mode allows you to continue programming and editing cues, groups, palettes and scenes without changing the onstage parameter values of fixtures. The Blind key is located above the Trackball; when in blind mode, the Blind key will illuminate.

Note that when you turn off blind mode all parameter values that you have changed in the Programmer or editor will instantly appear on stage.

To exit blind mode gracefully, hold down the Pig key while pressing Blind; parameters will fade to their new values in the assigned or default fade time. Alternatively, select Fade Changes in the editor you are using prior to turning blind on or off.



Tip

Using Pig + Blind on Hog 4 OS is equivalent to using the Try Cue key on the Wholehog II.

16.6 Parking

Sometimes it is useful to lock certain parameter values of fixtures independently from programming, playback and the Grand Master. For example, you might want to lock a particular dimmer at a certain level as a working light, or point a fixture to provide light for maintenance whilst a rehearsal or programming is in progress. Park is also helpful for dealing with a fixture malfunction, locking its pan and tilt so that it doesn't make a noise as it tries to move during the show.

Parking holds a fixture's parameters on stage, but still allows you to edit the data in the Programmer or other editors.

To park fixture parameter values:

1. Fixture **1 @ 50** : Select fixture(s) and assign the parameter(s) you wish to park.
2. More → Park : Select Park from the More options of the Main Toolbar.

To unpark fixtures, select the fixtures, set any value for the parked parameters, and hold the Pig key while pressing Park.

Both the park and unpark commands will accept a parameter mask on the command line, for example:

- Position Park : parks only position parameters of the selected fixtures.

16.6.1 Viewing and Editing What is Parked

You can view which fixtures have parked parameters in the Fixture window and the Output window, and you can view and edit parked parameters in the Parked Output window. Parked parameters are also indicated in the Wheels Toolbar.

The Fixture Window

To view which fixtures have parked parameters in the Fixture window:

- Open + Fixture : the Fixture window opens; see Figure 16.3, “The Parked column of the Fixture window”.

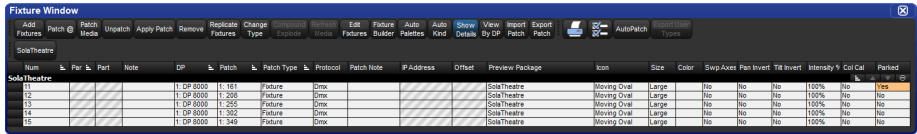

Figure 16.3. The Parked column of the Fixture window

The Output Window

Parked parameters are shown in the Output window with black text on an orange background. When the Output window Source view is selected the word ‘Parked’ is displayed.



The Parked Output Window

You can view and modify the parked settings of fixtures in the Parked Output window; see Figure 16.4, “The Parked Output window”. To open the Parked Output window:

- Open + Parked : the Parked button is on the toolbar that appears when you press the Open key.

Within this window you can edit parameter values in the same way as in any editor. You can knockout fixtures or parameter values to stop them being parked, or add or modify parameter values to park them.

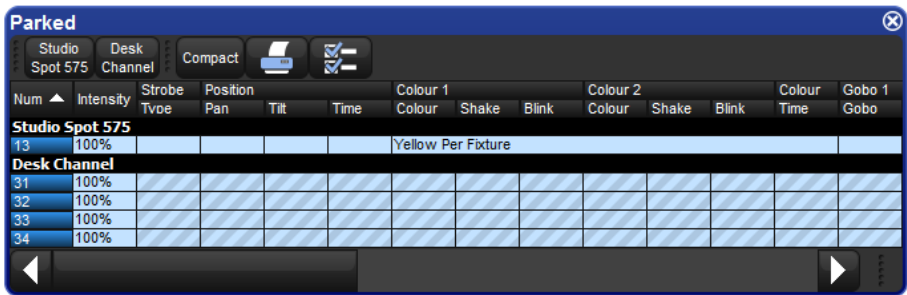

Figure 16.4. The Parked Output window

The Wheels Toolbar

Parked parameters are shown in the Wheels Toolbar with an orange background or hatch pattern.

- **Solid orange outline:** all selected fixtures have the parameter on this wheel parked.
- **Diagonal line orange background:** some of the selected fixtures have the parameter on this wheel parked.

Section 17: Playback

17.1 Physical Master Playback

Hog consoles have ten physical playback masters that cuelists, scenes, batches, and inhibitive submasters (groups) can be attached to for playback. Each physical master has one set of physical controls: a fader, a Go, key, a Halt/Back key, a Back key and a Flash key. Additional physical playback masters can be added to your console by adding a playback wing or executor wing. The following sections will cover how to configure and attach playback objects to physical masters and how to manipulate what the physical controls of a master are assigned to do.

17.1.1 Attaching Cuelists, Scenes, and Batches to Physical Masters

Cuelists, Scenes, and batches are automatically attached to a master when you create them using the Record, Choose syntax; see *Recording to a Cuelist on a Master* (p.213). However, if the cuelist, scene, or batch was created using the directory window then follow these steps to attach it to a physical master:

- List or Scene 1 Move Choose : attaches Cuelist 1 onto the chosen master.



Tip

You can move a cuelist, scene, or batch to multiple physical masters on a single page as well as across multiple pages. See *Pages* (p.335).

17.1.2 Moving and Copying between Physical Masters

Moving a cuelist between masters will detach it from its original master. Copying a cuelist between masters will leave the cuelist in its original location, and attach a copy of the cuelist to the new location.

To move a cuelist:

1. Press the Choose key of the master that you want to move the cuelist from.
2. Move
3. Press the Choose key of the master that you want to move the cuelist to.

To copy (and so duplicate) a cuelist:

1. Press the Choose key of the master that you want to copy the cuelist from.

2. Copy
3. Press the Choose key of the master that you want to copy the cue list to.

17.1.3 Detaching from a Physical Master

To detach a cue list from a master:

- Delete + Choose : detaches the cue list from the chosen master.

Note that this will not delete the cue list itself or remove it from the cue list directory, only detach it from the master.

17.1.4 Configuring Physical Master Playback Controls

Once attached to a physical master, cue lists, scenes, and batches can be played back using the hardware keys located below the physical master's choose key as well as via the console's main playback keys (located to the right of master 10 on Hog 4 / Full Boar 4, located to the left master 1 on Road Hog 4, and located to the right of master 5 on HedgeHog 4).

Hog 4 OS uses mappings called "control sets" to define which playback commands are executed when a hardware key is pressed. Every cue list, scene, and batch has five interchangeable master control sets (standard, intensity, playback rate, effect rate, effect size) and one main control set. This following two sections will cover how to access and customize these control sets as well as how to use them in playback.



Tip

Holding down the PIG key while pressing any one of a master's playback keys will release that master regardless of the function assigned to that key.

Master Control Sets

Every cue list, scene, and batch has five interchangeable master control sets (standard, intensity, playback rate, effect rate, and effect size) which contain playback command mappings for the physical master's Go, Halt/Back, Back, Flash, and Fader controls. When a cue list, scene, or batch is attached to a physical master, the standard control set is used by default.

To configure the master control sets for a cue list, scene, or batch already assigned to a physical master hold the pig key and then press the [choose] key coordinating with physical master to which the lists/scene/batch is assigned.

To configure the master control sets for a cue list, scene, or batch not already assigned to a physical master open the master window using the open syntax (example: [List] [1] [Open]) and then press the options button at the top of the master window.

See *Figure 17.1, "Master Control Sets"*.

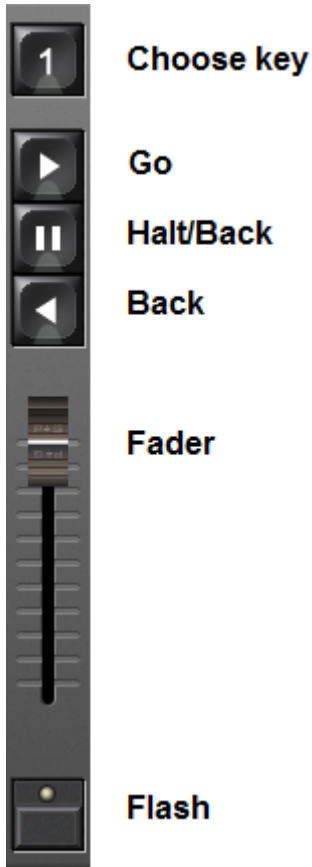

Figure 17.1. Master Control Sets

To change the master control set used by cue list, scene, or batch when it is attached to a physical master, hold the choose key for the physical master and select a different control set using the button menu located above the fader. The active control set will be highlighted in blue.

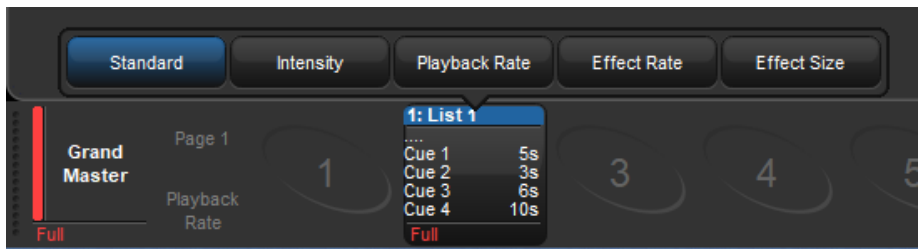

Figure 17.2. Master Control Set Assignment

The fader assignment for the currently active control set on a physical master can also be hot-swapped without needing to access the master options window. To hot-swap the fader for a control set, hold choose and press one of the onscreen encoder wheel toolbar buttons (located above the encoder wheels). The current fader assignment for the active control set will be indicated with a blue outline. For example, in the figure below the current fader assignment for the active control set is intensity (outline in blue). Pressing on the "playback rate" encoder wheel button using the touchscreen or mouse would switch the fader assignment under the current control set to scale playback rate.



Figure 17.3. Fader Assignment Hot Swap



Tip

Pressing or clicking on the Playback Bar is equivalent to pressing that master's Choose key.

Main Control Set

The main playback controls, typically positioned to the right of master 10 (see *Figure 17.4, "The Main Playback Controls"*) act upon the currently chosen master as well as any selected masters. The playback commands executed by the main controls are configurable for each cue list, scene, or batch.

To configure the main controls for a cue list, scene, or batch already assigned to a physical master hold the pig key and then press the [choose] key coordinating with physical master to which the lists/scene/batch is assigned. Navigate to the "main" tab.

To configure the main controls for a cue list, scene, or batch not already assigned to a physical master open the master window using the open syntax (example [List] [1] [Open]) and then press the options button at the top of the master window. Navigate to the "main" tab.



Figure 17.4. The Main Playback Controls

17.1.5 Playback Commands

Below is a list of the commands that can be assigned to the playback keys within a physical master control set and the main controls:

Commands assignable to all keys:	
<i>Command</i>	<i>Options and Notes</i>
None	Disables the control
Assert	Asserts the master. Deselect Use default cue list time to enter your own assert time for the master, overriding the cue list's assert time.
Release	Releases the master. Deselect Use default cue list time to enter your own release time for the master, overriding the cue list's release time.
Go	Go's the master. Deselect Use default cue list time to enter your own fade time for the master, overriding the cue list's time.
Halt	Halts the master, stopping any fades that are in progress. Select Use Fade Time to use the previous cue's fade time when going backwards instead of the cue list's Back Time. Select Trigger Cue List Macro to trigger the previous cue's macro when going backwards.
Back	Reverses the currently running crossfade. Deselect Use default cue list time to enter your own back time for the master, overriding the cue list's back time.
Restart	Goes to the first cue in the cue list.
Goto cmdline	Enters the Goto command into the command line, so that you can enter a cue number and press Enter to go to that cue.
Goto	Enter a cue number to go to in the Target Cue cell. Deselect Use default cue list time to enter your own fade time, overriding the cue's time.
Skip forward	Go instantly to the next cue.
Skip back	Go instantly to the previous cue.
Scale Playback Rate	Adjusts the playback rate of the master by applying a scaling value to the base playback rate of the master. <ul style="list-style-type: none"> • Temporary: When temporary is turned on scaling will be applied when button is pressed down and released when when button is released. • Action and Value: When action = "multiply" then button press will multiply scaling value by the value specified; when action = "set" then button press will change rate scaling value to value specified.
Scale Effect Rate	Adjusts the effect rate of the master by applying a scaling value to the base effect rate of the master. <ul style="list-style-type: none"> • Temporary: When temporary is turned on scaling will be applied when button is pressed down and released when when button is released. • Action and Value: When action = "multiply" then button press will multiply scaling value by the value specified; when action = "set" then button press will change rate scaling value to value specified.

Commands assignable to all keys:

Scale Effect Size Adjusts the effect size of the master by applying a scaling value to the base effect size of the master.

- **Temporary:** When temporary is turned on scaling will be applied when button is pressed down and released when when button is released.
- **Action and Value:** When action = "multiply" then button press will multiply scaling value by the value specified; when action = "set" then button press will change rate scaling value to value specified.

Scale Fader Assignment Adjusts scaling based on fader's control assignment. (i.e. if fader is assigned to "Scale Playback Rate" then a button assigned to "Scale Fader Assignment" will scale the playback rate).

- **Temporary:** When temporary is turned on scaling will be applied when button is pressed down and released when when button is released.
- **Action and Value:** When action = "multiply" then button press will multiply scaling value by the value specified; when action = "set" then button press will change rate scaling value to value specified.

Commands Assignable to Fader Control	
<i>Command</i>	<i>Options and Notes</i>
None	Disables the control
I Fader	<p>The fader controls fixture intensities being output by the master.</p> <ul style="list-style-type: none"> • Go Off Zero: The cuelist is triggered when the fader is moved from zero, as if you had pressed the Go key. • Release At Zero: The cuelist is released when the fader returns to zero; see <i>Releasing Masters</i> (p.300).
Manual cross-fader	The fader controls the crossfading between cues manually: move the fader to the bottom to 'pick up' the next cue, then move it up to start the crossfade.
IPCB crossfader	The fader manually controls the crossfading of the intensity, position, colour, and beam parameters of the current cue. When the fader is at the top of its travel the current cue will be 100% crossfaded onto stage. When the fader is at the bottom of its travel the current cue will be completely released.
Scale Playback Rate	<p>The fader adjusts the playback rate of the master by applying a scaling value to the base playback rate of the master.</p> <ul style="list-style-type: none"> • Upper Bound: : Determines the amount of scaling applied to the master when the fader is at top of travel (Full). • Lower Bound: Determines the amount of scaling applied to the master when the fader is at bottom of travel (0).
Scale Effect Rate	<p>The fader adjusts the effect rate of the master by applying a scaling value to the base effect rate of the master.</p> <ul style="list-style-type: none"> • Upper Bound: Determines the amount of scaling applied to the master when the fader is at top of travel (Full). • Lower Bound: Determines the amount of scaling applied to the master when the fader is at bottom of travel (0).
Scale Effect Size	<p>The fader adjusts the effect size of the by applying a scaling value to the base effect size of the master.</p> <ul style="list-style-type: none"> • Upper Bound: Determines the amount of scaling applied to the master when the fader is at top of travel (Full). • Lower Bound: Determines the amount of scaling applied to the master when the fader is at bottom of travel (0).

Commands Assignable only to the Flash key		
<i>Command</i>	<i>Notes</i>	<i>Options</i>
None	Disables the control	
Flash intensity at	Brings the intensity to a specified level regardless of the assignment of the fader. To specifically flash the assignment of the fader please use "Flash Fader at".	Level: proportion of the programmed intensity that contents are flashed to. If programmed levels are 80% and the flash level is set to 50% the flashed output intensity will be 40%.
Flash Fader at	Flashes fader assignment to level specified in the options. This is similar to "flash intensity at" except it flashes the command assigned to the fader and instead of flashing intensity.	Go On Flash : goes the master when the Flash key is pressed. Release on Off releases the master when the Flash key is released. Solo: sends intensity output of all other physical and virtual masters to zero while the Flash key is held.
Flash Fader Full	Flashes the command assigned to the fader to its highest level.	Latching: action of the Flash key is maintained until it is pressed a second time.
Flash Fader Zero	Flashes the command assigned to the fader to its lowest level.	
Flash Fader Opposite	Flashes the command assigned to the fader to either its highest or lowest level depending on the position of the fader. If the fader level is at 50% or higher then flash level is 0%. If the fader level is below 50% then the flash level is 100%.	* Latching the flash key can also be accomplished even when the latch option is turned off by pressing the pig key while the flash key is held, then releasing the flash key, and then releasing the pig key.

17.2 Virtual Master Playback

You can run cuelists without assigning them to a physical master by using virtual masters. An almost unlimited number of virtual masters running different cuelists can be in operation at any one time.

You can operate virtual masters from directory windows or from the command line.



Tip

You can press List + Release to release all running cuelists playing back as virtual masters.

17.2.1 Running Cuelists, Scenes, and Batches from the Directory Windows

You can run cuelists, scenes, and batches from their respective directory windows using the steps below:

- Open the list, scene, or batch directory window.

For example to open the list directory window: Open + List or List, List

Make sure that the **Guard** button at the top of the directory window is deselected. Now pressing and releasing any button in the directory will play back that object as if Go had been pressed. In addition, holding your finger down on the directory button is the equivalent of holding that master's Choose key, which allows you to use the central playback controls to act upon that virtual master.

The buttons in the directory are coloured to show the cuelist status:

- **Green:** actively cross-fading
- **Red:** paused in the middle of a cross-fade.
- **Purple:** releasing.
- **Grey:** overridden / stomped on by another cuelist or scene
- **Blue:** active on stage and halted
- **Teal:** active on stage, halted, and running effects.
- **Orange:** actively marking values.
- **Dark Blue:** active onstage, halted, and controlling fixtures that are assigned to a plot.



17.2.2 Using the Play Controls Toolbar to Play a Cuelist, Scene, or Batch

To run a cuelist, scene, or batch from the master window:

1. Open the master window for the cuelist, scene, or batch.
For example: (List 1), Open
2. Press the Play Controls button at the top of the master window. The on-screen playback controls will appear:

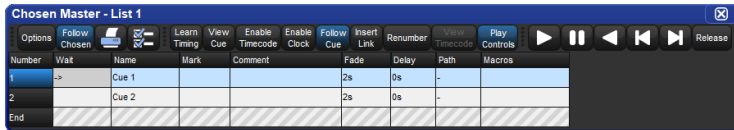

The controls are, from left to right, the Go, Halt/Back, Skip Back, Skip Forward, and Release buttons. These controls function independently from their front panel equivalents and always execute based on how they are labeled.

17.2.3 Running Virtual Masters from the Command Line

To run a virtual master from the command line type in the object's name, followed by its number, followed by enter. For example, to send a go command to cue list 1 you would type List 1, Enter . So send a go command to scene 1 you would type Scene 1, Enter .

17.3 Choosing and Selecting Masters

At all times one of the physical masters of the console is chosen. When a master is chosen its choose LED will be illuminated, the title of the master will be shown on the playback bar with a blue background, and the master's name will be announced on the main toolbar. The chosen master can be controlled using the play, halt, back, and pause keys in the main playback section of the console. The chosen master also directly receives commands from the command line such as record, goto, and delete when a destination is not otherwise specified. There can only be one chosen master at a time. To choose a master simply press the choose button associated with that master.

Masters can also be selected. Selected masters respond to rate wheel changes and the main playback controls but only the chosen master will receive commands from the command line. To select a master hold down the choose key of one master while pressing the choose keys of other masters. When selecting multiple masters the last choose key to be released will become the chosen master. When a master is selected it's choose LED will flash and the title of the master will be shown on the playback bar with a striped blue background.

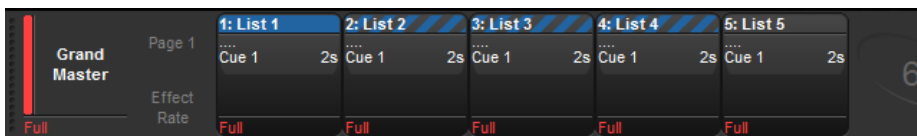

Figure 17.5. Example: Master 1 is chosen / Masters 2 thru 4 are selected

17.4 Releasing Masters

Releasing a playback object such as scene or cuelist relinquishes its control of all fixture parameters programmed into that cuelist or scene.

To release a cuelist or scene that is assigned to a physical master:

1. Press the choose key for the physical master that you wish to release.
2. Press the Release key located in the main playback section of the console.

Or:

- Release + Choose : use the Choose key of the master with the cuelist you wish to release.

When a cuelist is released its current cue indicator will remain on the last cue played so that when the cuelist is played again it will playback the same cue as when it was released.

To have the cuelist return to the first cue in the list when it is released turn on the reset on release option. See *Resetting Cuelists on Release* (p.302).



Tip

You can release all playbacks at once by pressing Pig + Release.

If no other cuelists or scenes are active when you release a cuelist or scene, then releasing returns all fixture parameters to their default values. A fixture's default parameter values will be determined by the Fixture Library; you can change the default values in the Edit Fixtures window, see *Assigning a Custom Default* (p.143).

If you have other cuelists or scenes active, then control of fixture parameters may be transferred to one of them; see *Latest Take Precedence (LTP)* (p.307).

17.4.1 Release Time

When you release a cuelist and fixture parameters go to their default values, they do so over the release time, and this change may be visible if you have fixtures that are visibly live on stage (i.e. with intensities above zero). To assign the cuelist's release time:

1. Open + Choose : open the Cuelist window for the cuelist on the selected master.
2. Options → Cuelist : open the Options window and select the Cuelist pane.

Alternatively, press Pig + Choose to open the Options window for the selected master.

3. Select the Release Time cell:

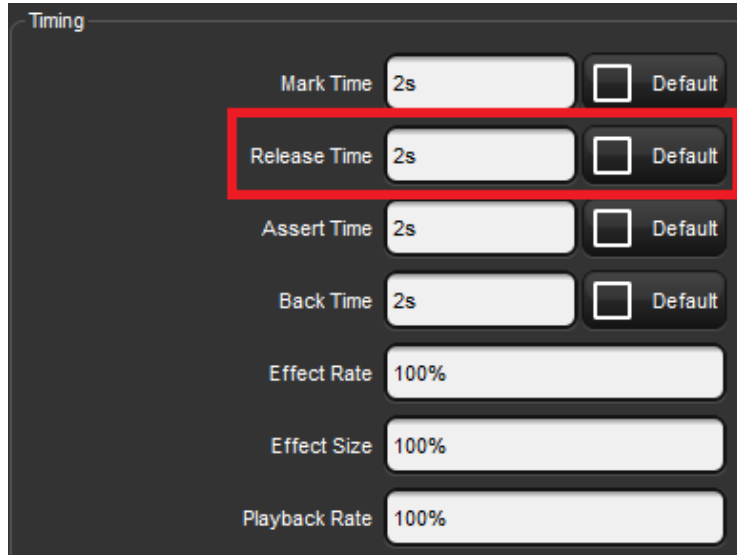

4. Set 5, Enter : assign the desired release time.

You can also set a default release time for all newly created cuelists in the Cuelist pane of the User Preferences window:

- Setup → Preferences → Cuelist



Tip

If you have assigned a release time to a cuelist, and you want to revert to the default release time, press the Default button adjacent to the Release Time cell.

17.4.2 Auto Release

You can use auto release options to send fixture parameters to their default values at the end of a show, or to relinquish control of parameters for use by other cuelists when a cuelist is no-longer needed.

There are two Auto Release options for cuelists:

- **Auto-release at End:** Use this to automatically release the Cuelist at the completion of the fade and delay times of the last cue.
- **Add Release End Cue:** After the last cue has run another press of the Go key will release the cuelist rather than running the first cue again.

You can assign auto release options in the Playback Options window of each cuelist:

1. Open + Choose → Options → Cuelist
2. Select the desired release option from the Action at End of List menu:

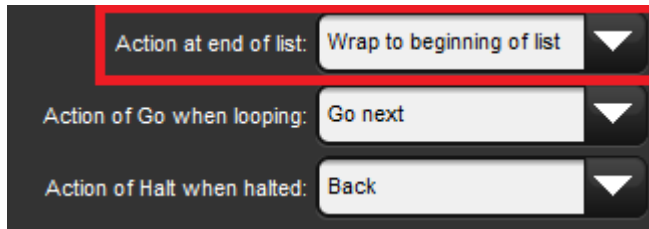

You can also assign the default Auto Release options for new cuelists in the Action at End of List menu in the Cuelist pane of the User Preferences window:

- Setup → Preferences → Cuelist

17.4.3 Resetting Cuelists on Release

You can assign a cuelist to reset when released so it will proceed from the first cue when Go is pressed again. You can assign Reset on Release in the Playback Options window of each cuelist:

1. Open + Choose → Options → Cuelist
2. Select Reset on Release:

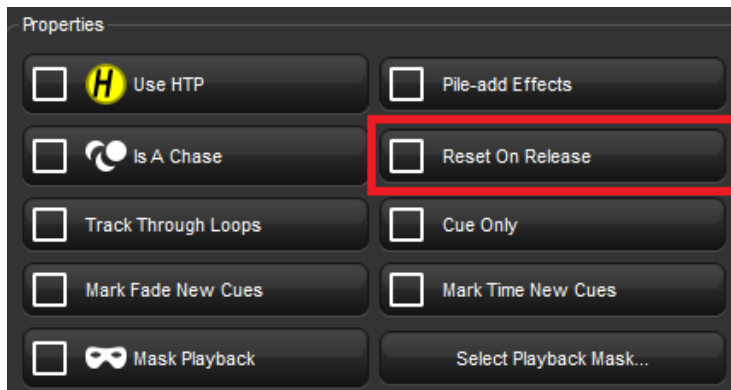

Alternatively, you can turn on Reset on Release for all new cuelists in the Cuelist pane of the User Preferences window:

- Setup → Preferences → Cuelist

17.4.4 Releasing on Another Go

When running several cuelists or scenes in a show, you may want a cueлист or scene to release when another cueлист or scene is triggered. This effectively gives the cueлист or scene the lowest possible playback priority; for more on playback priority, see *Changing a Cueлист's Priority* (p.309). You can enable the Release on Other Go option in the Playback Options window of each cueлист:

1. Open + Choose → Options → Cueлист
2. Select Release on Other Go:

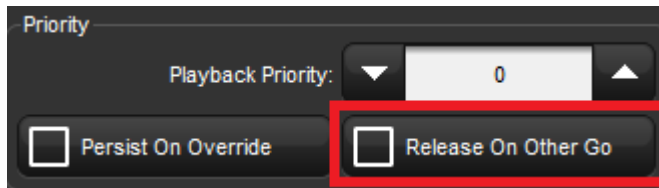

Alternatively, you can turn on Release on Other Go for all new cuelists in the Cueлист pane of the User Preferences window:

- Setup → Preferences → Cueлист

17.5 Master Playback Options

The priority, timing, and other various properties of a master that affect how it is played back are configured using the master's Playback Options window. This is the same for all master types (cueлист, scene, batch, group).

1. Open + Choose : opens the Master window.
2. Options : opens the Master's Playback Options window.

Alternatively, you can quickly access many of the master options from the options toolbar by holding down the Choose key of the master:



Tip

You can quickly open the playback options for a master by holding the Pig key and pressing the master's Choose key.

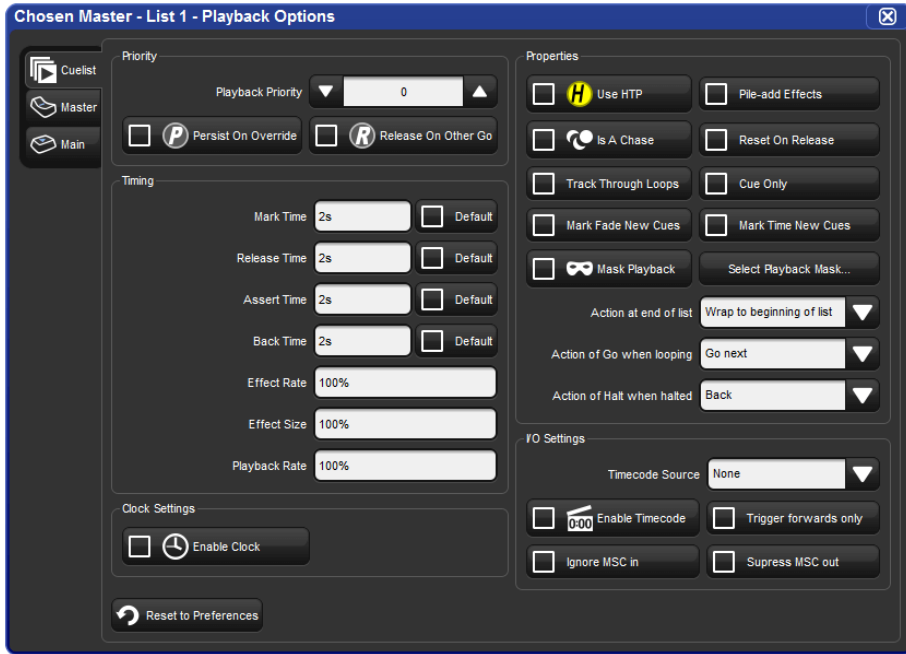

Figure 17.6. The Cuelist Pane of the Playback Options Window

You can configure the default playback options for new cuelists, scenes, and batches in the User Preferences window:

- Setup → Preferences → , select the Cuelist, Scene, or Batch tab

You can also customise the function of each of the master controls and main controls; see *Physical Master Playback* (p.289).



Tip

You can revert all of the playback options of the Cuelist, Scene, or Batch tab by pressing the Reset to Defaults button in the bottom left corner of the window.

17.5.1 Master Timing and Rate Settings

You can assign several settings that control cuelist timing:

Timing Function	Default	Notes
Release Time	2s	The time over which parameter values go to their default values when the cuelist is released; see <i>Releasing Masters</i> (p.300). Using the (global) option will refer the cuelist to use the global release time established in the show manager window under the show settings tab.
Assert Time	2s	The time in which parameters go to their values determined by the cuelist when the cuelist is asserted; see <i>Asserting One Cuelist Over the Others</i> (p.307). Using the (global) option will refer the cuelist to use the global assert time established in the show manager window under the show settings tab.
Back Time	2s	The time in which the cuelist steps back to the previous cue when the Halt key is pressed twice (to first halt the cuelist and then send it back). Using the (global) option will refer the cuelist to use the global back time established in the show manager window under the show settings tab.
Playback Rate	100%	Default proportion rate of the cuelist. A rate of 50% will double all cue timings, a rate of 200% will halve all cue timings.
Cue Only	Off	Releases previous cue's tracking values as you advance the list to the next cue. Tracking values are released using the total fade time of the cue being played.

**Tip**

If you have assigned a release, assert or back time to a cuelist, and you want to revert to the default time, press the Default button adjacent to the appropriate cell.

17.5.2 Cuelist Wrapping

Wrapping decides what happens to a cuelist when it reaches the final cue. Configure the wrapping in the Action at End of List menu:

- **Wrap to beginning of list:** Pressing Go after the final cue is reached sends the cuelist to its first cue.
- **Add release end cue:** Pressing Go after the final cue is reached releases the list and sends it to its first cue.
- **Auto-release at end:** The cuelist is released as soon as the last cue in the cuelist has completed all its fade and delay times.
- **Don't allow wrapping:** The cuelist stays on the final cue until released or sent backwards.

17.5.3 Cue Only

Cue Only enables a cuelist to playback cue data one cue at a time (otherwise known as a non-tracking cuelist). For example: any cue data in cue 1 is released as you play cue 2 so that only data from cue 2 is onstage. The release time of the previous cue is determined by the longest fade time in the cue being played.

17.5.4 Action of go when Looping

When the cuelist is performing a continuous loop with the use of a link cue, you can configure the effect of pressing the Go key using the Action of Go When Looping menu:

Action	Notes
Exit loop immediately	Jumps the cuelist to the link cue at the end of the loop. Use a wait time on the cue after the link if you want to go to that cue automatically when exiting the loop.
Exit loop at end	Allows the loop to proceed to the last cue before jumping to the link cue at the end of the loop. Use a wait time on the cue after the link if you want to go to that cue automatically when exiting the loop.
Restart	Jumps immediately to the first cue in the loop.
Stop at next	Stops at the next cue in the loop.
Go Next	Advances the cuelist forward by a single cue when go is pressed.

For more information on loops, see *Loops and Links* (p.254).

17.5.5 Action of Halt when Halted

By default, pressing the Halt key when a cue is halted steps the cuelist back a cue in the assigned back time, see *Master Timing and Rate Settings* (p.304). You can change this action using the Action of Halt When Halted menu:

Action	Notes
None	The current cue remains halted.
Back	The cuelist crossfades into the previous cue using the back time assigned to the cuelist.
Resume	The current cue continues to fade.
Release	The cuelist is released, see <i>Releasing Masters</i> (p.300).
Toggle FX	Toggles effects between running at 0 BPM and the programmed rate

17.6 Latest Take Precedence (LTP)

Because Hog consoles can simultaneously run ten cuelists on masters (and more if virtual masters and playback wings are used) the question arises as to which master actually has control over a particular fixture parameter. To decide which master takes precedence Hog 4 OS applies the following rules:

- **For intensity parameters:** by default, intensity parameters are controlled on a Latest Takes Precedence (LTP) basis, therefore the value of an intensity parameter that appears in several cuelists will be output from the cuelist with the highest playback priority; see *Changing a Cuelist's Priority* (p.309).
- **For position, colour and beam parameters:** Hog 4 OS always deals with position, colour and beam parameters on a Latest Takes Precedence (LTP) basis. If several masters have programming for the same parameter then the value from the most recently activated master will override the value from previously activated masters. Parameters that are only programmed into a single master will remain at that value. When you release the most recently activated master, control will be returned to the previously activated master. Alternatively you can assert a previously activated master's parameters so that they override the most recently activated master; see *Asserting One Cuelist Over the Others* (p.307). You can prevent an (LTP) parameter from being overridden by master actions or assertions by giving its cuelist a high playback priority; see *Changing a Cuelist's Priority* (p.309).



Tip

The Programmer, or the current editor with blind mode off, will always have priority over all masters and virtual masters.

17.6.1 Asserting One Cuelist Over the Others

When you have several cuelists active at the same time, control of fixture parameters programmed into one cuelist may be taken by another cuelist that also has programming for that fixture parameter. For example, if Cuelist 1 has programming for desk channels 1-3, and Cuelist 2 has programming for desk channels 3-6, then running a cue in Cuelist 2 will override the intensity parameter of desk channel 3.

You may want to return control of desk channel 3 to Cuelist 1 without having to run a cue in Cuelist 1; this is known as asserting Cuelist 1. Asserting a cuelist forces all fixture parameters to their programmed value in the cuelist.

To assert parameters on the cuelist attached to Master 3, for example, press and hold the Choose key for Master 3, and press the Assert key.

The Assert Time

When you assert a cueлист, the parameters that have been asserted change to their new values over the assert time. The default is 2 seconds, but you can assign your preferred assert time for each cueлист:

1. Open + Choose → Options → Cueлист
2. Select the Assert Time cell:

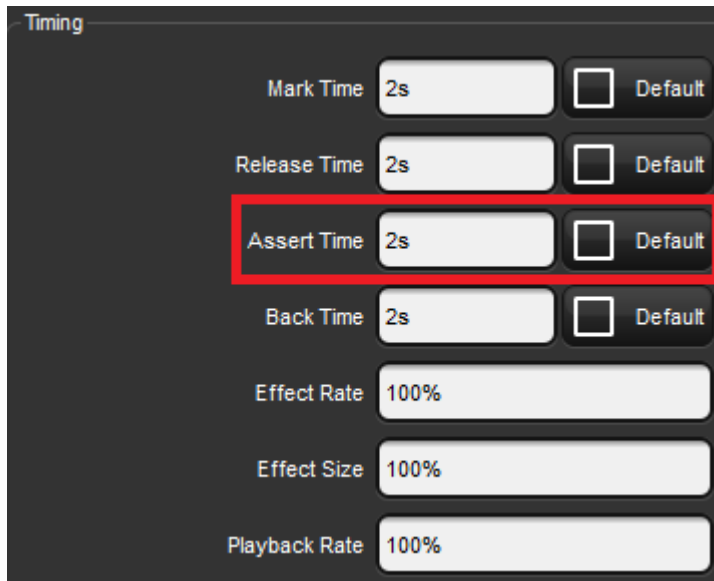

3. Set 5, Enter : change the assert time to 5 seconds.

Alternatively, you can assign the Assert Time for all new cuelists in the Cueлист pane of the User Preferences window:

- Setup → Preferences → Cueлист



Tip

If you have assigned an assert time to a cueлист, and you want to revert to the default assert time, press the Default button adjacent to the Assert Time cell.

17.6.2 Multiple Cuelists with Effects

If a cueлист contains parameters that are running an effect, when another cueлист or scene changes the underlying values of those parameters the effect continues to run. Use Pile-Add FX to allow the second cueлист or scene to override the effect as well as the underlying values.

For example, to allow the cuelist on Master 10 override effects running on other masters:

1. Open + Choose : open the Cuelist window for Master 10.
2. Options : open the cuelist's Playback Options window.
3. Select the Cuelist pane and select Pile-Add FX:

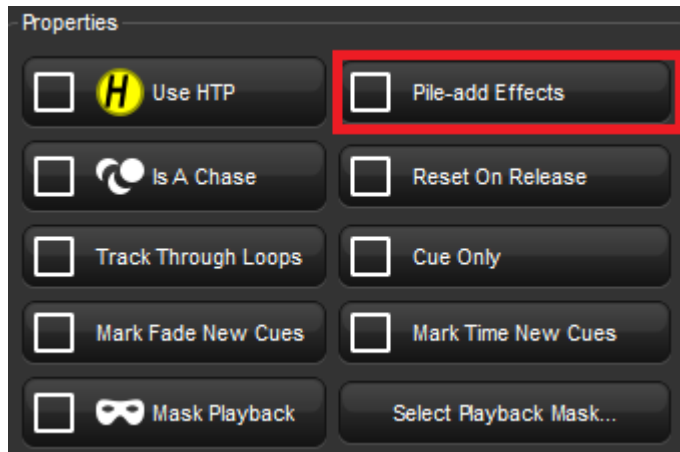

17.6.3 Changing a Cuelist's Priority

Under the LTP rule, the most recent action determines the value of a fixture parameter; see *Latest Take Precedence (LTP)* (p.307). However, you can override this precedence by assigning cuelists different priorities, so that cuelists with a higher priority take precedence over those with a lower one. If their priority is equal, then the LTP rule is used to determine which cuelist will take precedence and determine the parameter's value.

A cuelist's default priority is 0, and you can assign the priority value in increments of 10. For example, if the priority of the cuelist attached to Master 5 is at default (0) and the priority of that on Master 4 is 50, then a Go triggered on Master 5 will not override common parameters currently active on Master 4. Conversely, you can apply a minus priority so if the cuelist on Master 3 has a priority of -50, common parameters on Master 5 will override those on Master 3.

To change a cuelist's priority:

1. Open + Choose → Options → Cuelist
2. Select the Playback Priority cell:

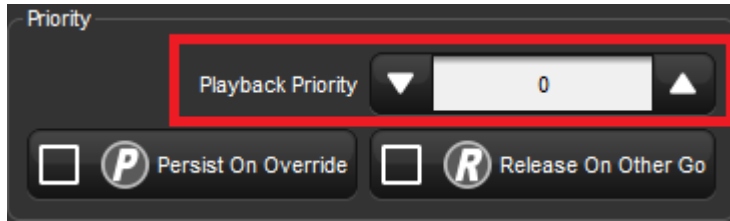

3. Set **50**, Enter : change the priority to 50.

Alternatively, you can assign the Playback Priority for all new cuelists in the CueList pane of the User Preferences window:

- Setup → Preferences → CueList

In the event that two or more cuelists share the same priority level, normal LTP rules are applied.

Persist on Override

Hog 4 OS automatically releases cuelists when all of their parameter contents have been overridden by other cuelists. However, sometimes it is useful to return to a cuelists's look when overriding cuelists have been released; in this case you can use Persist on Override. When this option is activated, the overridden cueList will not automatically release and will remain active when the overriding cueList is later released.

To turn Persist on Override on for a cueList:

1. Open + Choose → Options → CueList
2. Select Persist on Override:

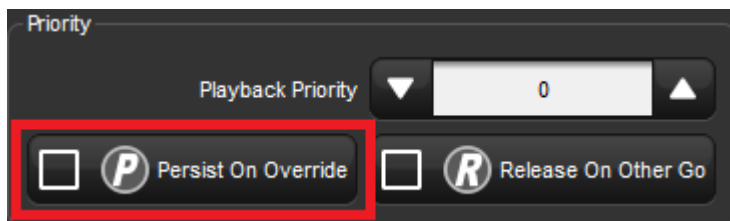

Alternatively, you can assign Persist on Override for all new cueLists in the CueList pane of the User Preferences window:

- Setup → Preferences → CueList

17.7 Highest Takes Precedence (HTP)

You can switch a cuelist's precedence from LTP to HTP, allowing intensity parameters that have programming to be output at their highest level rather than the most recently activated level. For example, you may have a series of intensity chases that you wish to fade in and out over a stage look without overriding the intensity information of the original look, or when touring with smoke machines you may wish to manually boost the level of smoke programmed into the main cuelist to combat changes in air conditioning or venue size at specific points in the show.

To assign a cuelist's precedence to HTP:

1. Open + Choose → Options → Cuelist
2. Select Use HTP:

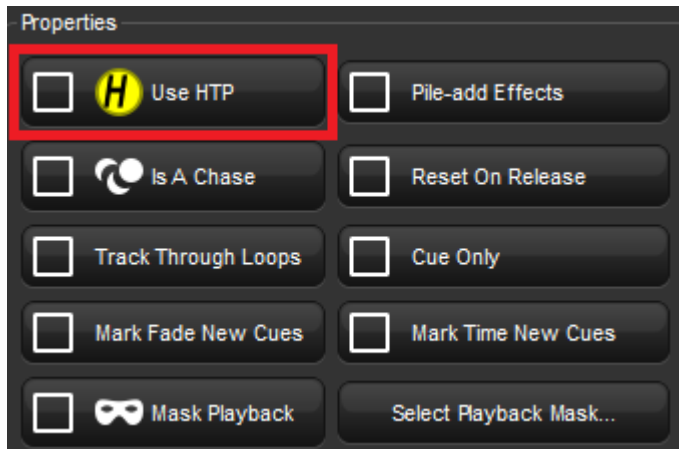

Alternatively, you can turn on Use HTP for all new cuelists in the Cuelist pane of the User Preferences window:

- Setup → Preferences → Cuelist



Important

If you have an HTP master with the fader up (i.e. intensities above zero), then using Release or Pig + Release has no effect on the intensity parameters. To release the intensities of HTP masters, bring the fader to zero. For more on releasing cuelists, see *Releasing Masters* (p.300).

17.8 Understanding Feedback

There are several ways in which you can tell the status of the console's output:

- The status of masters is shown by the playback control key LEDs and the on-screen Playback Bar.
- You can use a master window to follow the progress of running cuelists.
- The total output of all fixtures' parameter values is shown in the Output window, and the total output of all fixture's intensities is shown in the Levels View window.

17.8.1 Control and Playback Toolbar Feedback

Playback Control LEDs

The LEDs of the playback controls give information about the cuelist's status:

- **Go key (Green):** When solidly lit, indicates that a forward crossfade is in progress. When flashing, indicates a forward crossfade has been paused.
- **Halt/Back key (Red):** When solidly lit, indicates that the master is active and controlling parameters. When flashing slowly, indicates that its control of parameters has been overridden by other playbacks. When flashing quickly, indicates the master is releasing.
- **PlayBackwards key (Green):** When solidly lit, indicates an active crossfade to the previous cue. When flashing, indicates that a crossfade to a previous cue has been paused.
- **Flash key (Red):** When solidly lit, indicates that this playback is controlling intensity. When flashing, indicates that its control of intensity has been overridden by other playbacks.

The Playback Bar

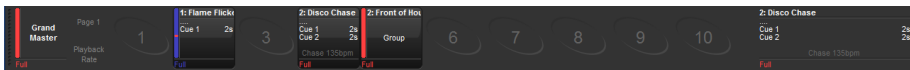









Figure 17.7. The Playback Bar

Playback Bars are typically displayed at the bottom of the left touchscreen and give feedback for the objects assigned to each physical master; see *Figure 17.7, "The Playback Bar"*. For each master, the Playback Bar displays the following information:

- If a master is empty, its master number is shown.

- The number and name of the cuelist, scene, group, or batch assign to the master. This is shown in blue if the master has been held over after a page change; see *Options When Changing Page* (p.336). The name and number will appear in lavender if the master is from a template page; see *The Template Page* (p.342).
- For lists: the current cue and its overall time followed by the next few cues and their times. If you want to see more cues, click and drag the top of the Playback Bar upwards to make it larger. When a cue in a list is crossfading, it is displayed in green text and the time counts down. If the cuelist has been released, then is displayed, with the next cue shown below.
- For scenes: the scene and its overall time. When a scene is cross-fading, it is displayed in green text and the time counts down. If the scene has been released, then is displayed, with the scene name shown below.
- For groups: the text "Group" will be written in the master cell. Groups assigned to the playback bar are commonly referred to as Inhibitive Masters as they can inhibit the intensity of all fixtures in that group based on the master's fader level.
- For batches: individually numbered cells that represent the lists and scenes assigned to the batch will appear inside the batch's playback bar display. Lists are represented solely by a number whereas scenes are marked with an "s" before the number. The running state of each list and scenes is then indicated by the background color of the cell.
- Each master's fader level. If the fader is below 100%, then a red bar appears indicating the level. It is possible for the position of the physical fader to be different to the master level of the cuelist, in which case the vertical bar will be blue; see *Matching Levels When Changing Page* (p.338).
- If the cuelist is a chase. If it is, then its rate in BPM is shown; see *Using a Cuelist as a Chase* (p.323).
- Options set for the cuelist will appear at the bottom of master on the playback bar. The symbols used are shown in the table below:

Symbol	Description
	The cuelist is working under the HTP rule.
	The cuelist is set to Persist on Override. See <i>Changing a Cuelist's Priority (p.309)</i> .
	The cuelist is set to Release on Other Go. See <i>Releasing on Another Go (p.303)</i> .
	The cuelist has a high priority. See <i>Changing a Cuelist's Priority (p.309)</i> .
	The cuelist has a low priority. See <i>Changing a Cuelist's Priority (p.309)</i> .
	The scene uses the master as an IPCB fader. Note that this applies to scenes only.
	The cuelist uses the master as a manual fader. See <i>Manually Cross-fading Cuelists (p.321)</i> .

Using the Playback Bar with Playback Wings

Multiple Playback Bars can be displayed using the Wings pane of the Control Panel or using the front panel shortcuts mentioned in *Adding Playback Wings (p.82)*. Once a playback bar is displayed on the desktop it can be dragged to different locations on the display by clicking and dragging on the drag handle on the left hand side of the playback bar. The recommended location for a playback bar is at the bottom edge of the display as it helps to associate the playback bar with the physical controls of the wing that is located under the display.

You can also click and drag on the outside edges of the Playback Bar's master area to better align the playback bar's masters to the physical masters on the hardware.

For information on adding and setting up playback wings, see *Adding Playback Wings (p.82)*.

17.8.2 Cuelist Feedback

The master window for a cuelist shows all of the cues in the cuelist as well as their running state. (see *Figure 17.8, "The Cuelist Window with a Cue Running"*):

- Open + Choose

Or:

- Double click the Playback Bar above the required cuelist.

Or:

- Open + (List 1) : select the cuelist from the cuelist directory.

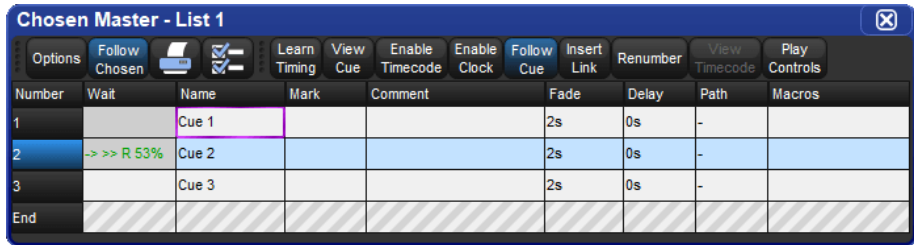

Figure 17.8. The Cuelist Window with a Cue Running

The current cue is indicated by an arrow in the wait column and a light blue background across the entire cue row. When a cue is triggered the arrow turns green and the letter R (for Running) is displayed; the cue's progress is indicated by the percentage completed in the same column. Pausing a cue will turn the arrow red and the letter H (Halted) is displayed.

Customising Cuelist Feedback

There are several view options selected by buttons at the top of Cuelist window:

- **Play Controls:** displays alternative play controls at the top of the Cuelist window. These are useful for running virtual masters, see *Using the Play Controls Toolbar to Play a Cuelist, Scene, or Batch* (p.298).
- **View Cue:** opens the current cue (as denoted by an arrow in the wait column) in an editor.
- **Follow Cue:** selecting Follow Cue from the top of the Cuelist window will make the list of cues scroll to keep the current cue in view as the cues are played back.
- **Follow Chosen:** during playback, you may not want to have multiple Cuelist windows open. Select Follow Chosen from the top of any Cuelist window so Hog 4 OS automatically displays the cuelist of the currently chosen master. If Follow Chosen is off, the same cuelist will always be shown in the window irrespective of the chosen master.
- **View Timecode:** turn the display of timecode information on or off.

17.8.3 The Output Window

The Output window displays the output value of all parameters controlled by Hog 4 OS from all cuelists, virtual cuelists, scenes, the Programmer and other editors, and parked parameters. It provides an accurate indication of the status of shared parameter values when multiple cuelists are running simultaneously; see *Figure 17.9, "The Output Window"*.

To open the Output window:

- Press and hold the Open key, then select Output from the Main Toolbar.

Or:

- Select Output from the View Toolbar at the top of the left hand touch-screen.

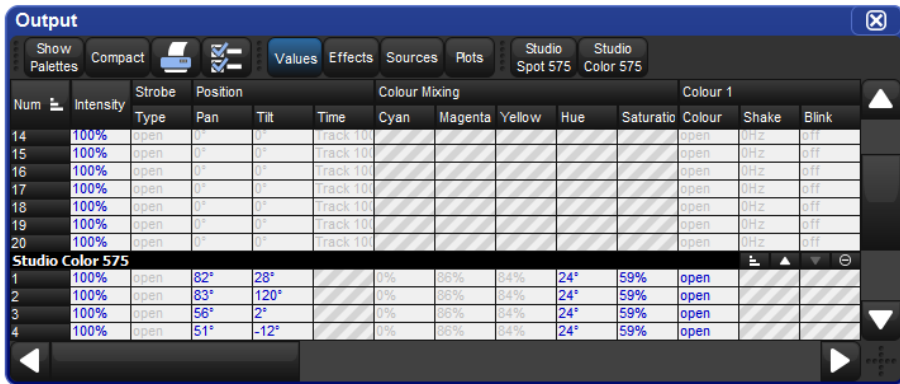
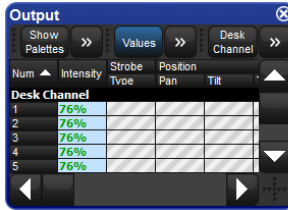

Figure 17.9. The Output Window

The Output window by default displays raw parameter values; you can configure it via buttons at the top of the window to display output information in the following ways:

- **Values:** displays the raw parameter values.
- **Effects:** displays the base value before the effect is applied, along with a percentage indication of the effect cycle.
- **Sources:** displays the source that currently has control of a parameter, for example, the Programmer or a cuelist and cue number.
- **Plots:** displays the name of the plot that has control of the parameter; if you want to see the real world value being calculated by the plot for the parameter then choose "value" instead of "plots"
- **Show Palettes:** as with sources, displays the palette that is supplying the parameter value.
- **Compact:** Compacts the display of information in the window; see *Compact Mode (p.39)*.

Cross-fading values will appear in the Output window in the following colors:



Green: values are in a Go state

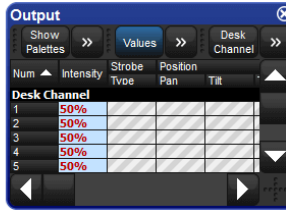

Red: values are in a pause state

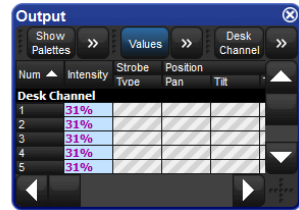

Purple: values are in a release state

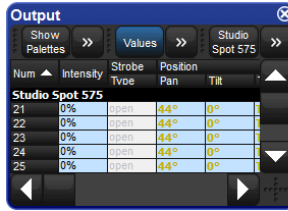

Orange: values are in a mark state

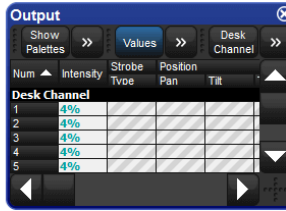

Teal: values are from an effect

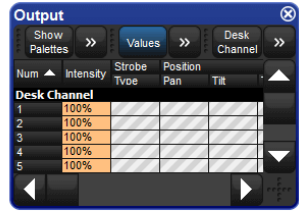

Black text on orange: values are parked

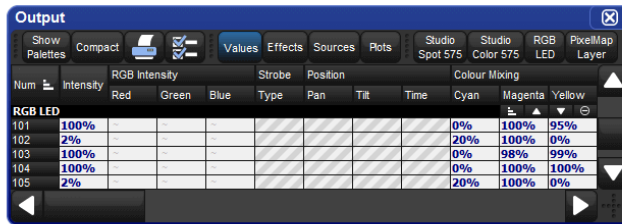

Bold Dark Blue: values are from a plot

17.8.4 The Levels View Window

The Levels View window displays the output value of all intensities controlled by Hog 4 OS from all cuelists, virtual cuelists, scenes, the Programmer and other editors, and parked parameters. It provides an accurate indication of the status of shared intensity values when multiple cuelists are running simultaneously; see *Figure 17.10, "The Levels View Window"*.

To open the Levels View window:

- Press and hold the Open key, then select Levels from the Main Toolbar.

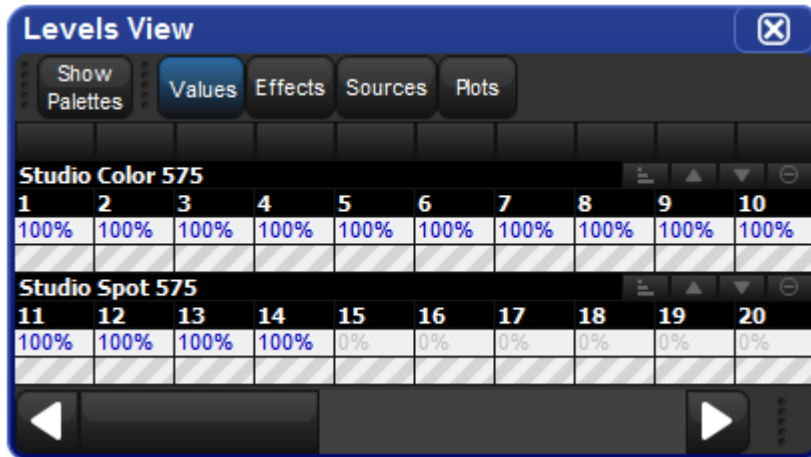
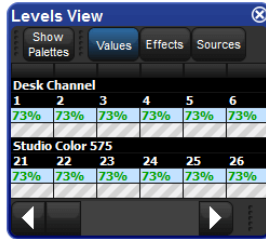

Figure 17.10. The Levels View Window

The Levels View window by default displays raw intensity values; you can configure it via buttons at the top of the window to display output information in the following ways:

- **Values:** displays the raw parameter values.
- **Source:** displays the source that currently has control of an intensity, for example, the Programmer or a cue list and cue number.
- **Plots:** displays the name of the plot that has control of the parameter; if you want to see the real world value being calculated by the plot for the parameter then choose "value" instead of "plots"
- **Show Palettes:** as with source, displays the palette that is supplying the intensity value.

Cross-fading values will appear in the Levels View window in the following colors:



Green: values are in a Pause state

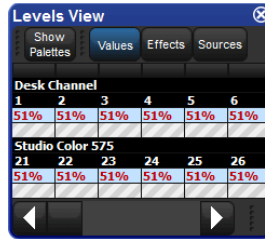

Red: values are in a Release state

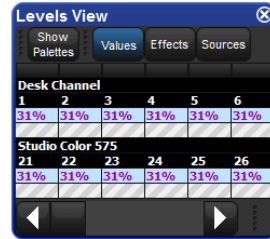

Purple: values are in a Release state

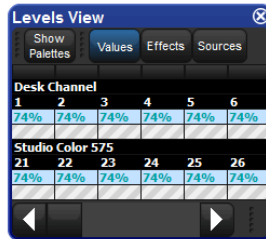

Teal: values are from an Effect

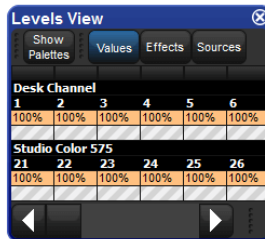

Black text on orange: values are Parked

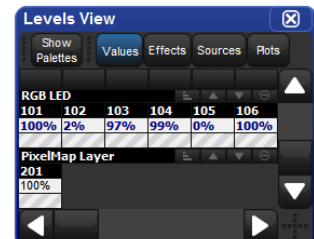

Bold Dark Blue: values are from a Plot

17.9 Advanced Playback

17.9.1 Adjusting the Playback and Effect Rates of a Master

The playback and effect rates of a master (cuelist, scene, chase) can be adjusted several different ways:

- **Changing the playback and effect rate fields in the cuelist/scene options window:** The simplest way to adjust the playback and effects rates of a master (cuelist, scene, chase) is to open the options window for that master and modify the playback and effect rate fields. Any modifications made to the playback and effect rate fields in the options window are stored and persisted for that cuelist/scene as the "base rate".
- **Holding choose and adjusting the main encoder wheels:** Press and hold the Choose key for a master and use the parameter wheels to adjust the playback and effects rates. Any modifications made to the playback and effect rates via the encoder wheels are stored and will persist for that cuelist/scene as the "base rate".
- **Using the Rate Wheel:** The wheel located on the left hand side of the console is known as the rate wheel. The rate wheel allows users to make temporary modifications to the base playback and effects rates for the

chosen and selected masters. To toggle the rate wheel mode (playback, effect, none) press the rate key located below the rate wheel. The rate wheel's mode is displayed on the main playback bar (base rate + rate wheel modification). Moving the rate wheel in the upward direction will increase the selected rate while moving the wheel in the downward direction will decrease the selected rate. To clear the rate wheel's modifications for the active rate mode of the rate wheel press the restore key located above the rate thruster. You can also clear rate wheel modifications by holding choose for a master and pressing the encoder wheel button for the matching rate on the main encoder wheels. To permanently store the rate wheel's modifications for a cuelist/scene master hold the pig key and press the restore key. You can also permanently add the rate wheel's modifications into the base rate of a master by holding choose and turning the encoder wheel matching the rate on the main encoder wheel. Any rate thruster modifications that are not stored are lost when the master is released.

- **Assigning the fader of the master to "Scale Playback Rate" or "Scale Effect Rate" in the cuelist/scene options window:** Assigning the physical fader control of a master to "Scale Playback Rate" or "Scale Effect Rate" allows users to utilize the physical fader of the master to scale (multiply & divide) the base playback rate (or base effect rate) of the master. The middle of the fader travel always equals 1x scaling (no scaling applied) while moving the fader up or down adjusts the associated rate by multiplying/dividing against the base playback/effect rate. The upper and lower boundary options of the scale options determine how much scaling is applied as the fader is moved.
- **Assigning the button controls of the master to "Scale Playback Rate" or "Scale Effect Rate" in the cuelist/scene options window:** Assigning any of the physical button controls of the master to "Scale Playback Rate" or "Scale Effect Rate" allows users to scale (multiply & divide) the base playback rate (or base effect rate) of the master with a single button press.

17.9.2 Adjusting the Effect Size of a Master

The effect size of a master (cuelist, scene, chase) can be adjusted several different ways:

- **Changing the effect size field in the cuelist/scene options window:** The simplest way to adjust the effect size for a master (cuelist, scene, chase) is to open the options window for that master and directly modify the effect size field. Any modifications made to effect size field in the options window are stored and persisted as the "base size".
- **Holding choose and adjusting the main encoder wheels:** Press and hold the Choose key for a master and then use the parameter wheels to adjust the effects size for the selected master. Any changes you make the base effect size for a master are stored and will persist as the "base size".

- **Assigning the physical fader of the master to "Scale Effect Size" in the cuelist/scene options window:** Assigning the physical fader control of a master to "Scale Effect Size" allows users to utilize the physical fader to scale (multiply & divide) the base effect size of the master. The middle of the fader travel always equals 1x scaling (no scaling applied) while moving the fader up or down will begin to adjust the size of the effects playing back on the master by multiplying/dividing the base effect size of the cuelist/scene. The upper and lower boundary options of the "Scale Effect Size" option determine how much scaling will be applied to the master's base effect size when the fader is moved.
- **Assigning the button controls of the master to "Scale Effect Size" the cuelist/scene options window:** Assigning any of the physical button controls of the master to "Scale Effect Size" allows users to scale (multiply & divide) the base effect size of the master with a single button press.



Tip

Pressing an encoder wheel cell on the touchscreen while holding choose for a master will assign the physical fader for that master to the coordinating fader function (scale playback rate, scale effect rate, scale effect size, intensity). The current fader assignment of a master is indicated by a blue outline around the coordinating encoder wheel cell on the touchscreen.

17.9.3 Manually Cross-fading Cuelists

You can assign any cuelist to be operated manually, allowing you to perform the cross-fades from one cue to the next manually using the fader. Once a cuelist's Manual Fade option is selected, the Master's fader will no longer control intensity but instead the cross-fade progress of all parameters from the current cue to the next; starting when moved from any end stop, finishing when the opposite end stop is reached.

If you select Manual Fader mode when the fader is at 50%, a manual fade cannot take place until the fader is moved to and then from an end stop, further moves from end stops will manually work through the cuelist sequentially.

To assign a cuelist's Manual Fade function:

1. Open + Choose → Options → Master
2. Select Manual Crossfader from the Fader menu:

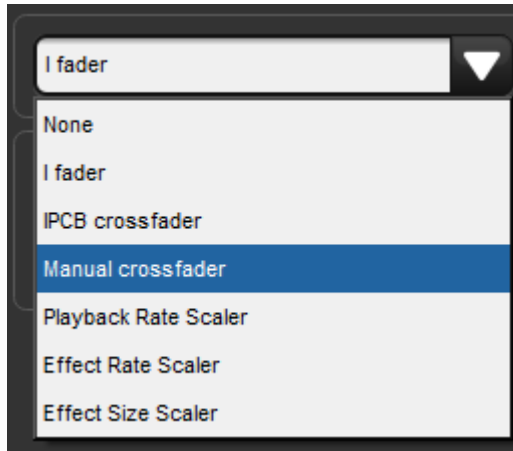

Manual cross-fade mode will be indicated on the Playback Bar above the selected master by



Tip

You can still run cues to time when manual fader mode is selected by pressing the master's Go key. Note that you have no individual fader control of intensity and accidentally moving a fader will start to run the next cue manually.

17.9.4 IPCB Faders

You can adjust the output values of any intensity, position, colour or beam parameter information in any cuelist by assigning its fader as a IPCB fader.

To assign a cuelist to use the IPCB fader function:

1. Open the Programmer from the Main Toolbar. In the Programmer select the fixtures and parameters that you wish to adjust with the fader, then assign a maximum level.
2. Record **1** Enter : record the cue to the chosen master.
3. Pig + Choose → Playback Options : open the options window for the cuelist's master.
4. In the Master pane, select IPCB Crossfader from the Fader drop down menu.

You can now adjust the value of the parameters contained in the IPCB fader cue by adjusting the master's fader level.

17.9.5 Using a Cuelist as a Chase

You can use a cuelist to make a chase. Any wait times are ignored, and each cue becomes a step in the chase where the rate is set in Beats Per Minute(BMP).

To use a cuelist as a chase:

1. Open + Choose → Options → Cuelist
2. Select Is a Chase:

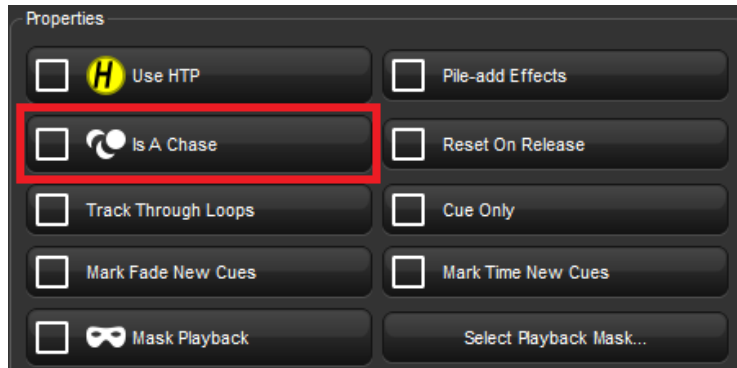

The Playback Bar displays Chase and the playback rate (which defaults to 120 bpm):



Each cue step is by default equivalent to a beat, so to set a chase that advances every second the rate needs to be 60 bpm. By holding down the master's Choose key you can modify the playback rate, effect rate, and effect size on the parameter wheels:

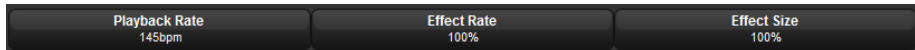

When you select Is a Chase the Cuelist pane of the Playback Options window, the following chase options appear:

- **Playback Rate:** the speed of the chase defined in Beats Per Minute (bpm).
- **Crossfade:** the amount of each step that a cross-fade is active for, as a percentage.
- **Step Length:** by default each cue step is the equivalent to a beat. This is helpful when you enter a rate using Tap Sync, but then wish the chase

to step at half or double speed. For more on Tap Sync, see *Adjusting Chase Rate with Tap Sync* (p.325).

- **Direction:** four directions are available: Up, stepping up through cue numbers; Down, stepping down through cue numbers; Random, stepping randomly through cue numbers; and Bounce, stepping up then down through cue numbers.

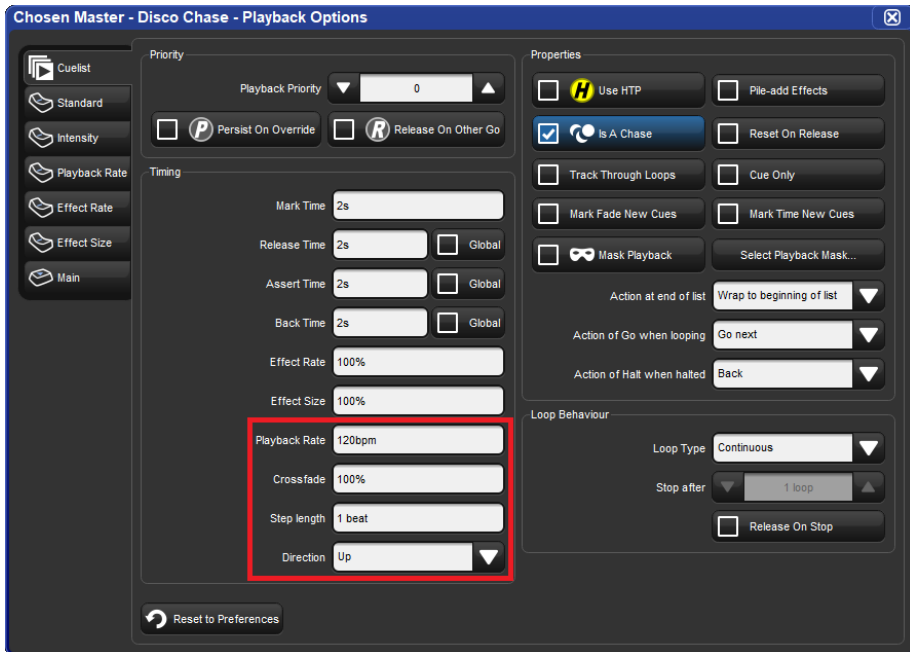

You can also configure the following loop types in the Cuelist pane of the Playback Options window:

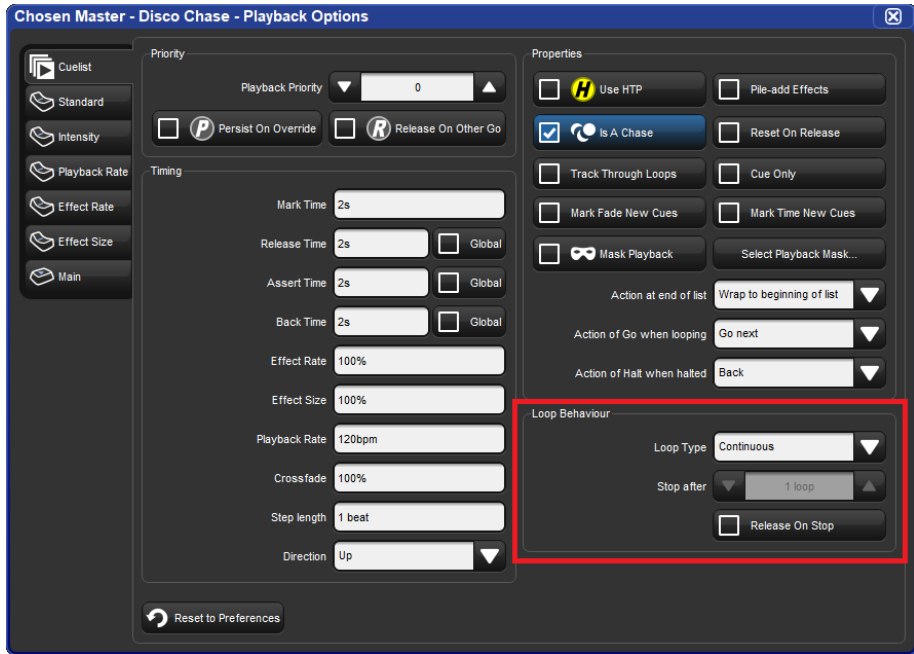

- **Continuous:** the chase steps indefinitely until paused or released.
- **Stop On Last:** the chase stops at the last cue in the cuelist until released or triggered again with a Go.
- **Release On Last:** the cuelist chase is released when it reaches the final step.
- **Stop On First:** the chase completes one cycle and stops on the first cue until triggered again.

If any loop type other than continuous is chosen then you can assign the number of cycles the chase completes before the loop behaviour is actioned. Selecting Release on Stop releases the chase cuelist either when it stops because of an actioned loop behaviour or because of a manual stop using the Halt key.



Tip

The Playback Options of a master can be quickly accessed by holding Pig and pressing the master's Choose key.

Adjusting Chase Rate with Tap Sync

A cuelist chase can be manually synced to a beat, such as a piece of music, using Tap Sync. Once synced Hog 4 OS maintains the chase rate until a new one is assigned.

To adjust the rate of a chase using Tap Sync, hold down the Choose key of the master the chase is attached to, while pressing the master's Go key repeatedly to the required

beat. Hog 4 OS will learn the speed of the chase from you, in a minimum of two beats; after this, you can release the Choose key.

Note that you can only use Tap Sync with chases loaded onto physical masters, not virtual ones.

17.9.6 Cuelists and Tracking

You can define how a cuelist deals with tracking in the Cuelist pane of the Playback Options window (shown in *Figure 17.6, “The Cuelist Pane of the Playback Options Window”*):

- Open + Choose → Options → Cuelist

The options are:

Option	Default	Notes
Cue Only	Off	Use this to run the cuelist without tracking . Any parameter that has no value in a cue will go to its default value , rather than tracking through from the previous cue.
Track Through Loops	Off	Determines whether parameter values track from the end of a loop back to the beginning. See <i>Tracking Through Loops (p.256)</i> for a full description.

17.9.7 Triggering Automatic Tasks When a Cue Runs

You can use Trigger Macros to perform a variety of tasks when a cue runs. Macros are simple text instructions placed in the cue's Macro cell:

1. Open + Choose : open the Cuelist window.
2. Select the Macro cell for the desired cue, and press Set.
3. Type in the Macro command, then press Enter.

For a full description of the available macro commands, see *Macros (p.399)*.



Tip

You can display a list of available commands on the console by selecting the Macro cell in the Cuelist window and pressing the Set key.



Tip

You can enable trigger macros to occur when using the Back key to go backwards through a cuelist.

17.9.8 Playback Masking

You can mask which fixture function kinds that a cuelist or scene will playback by applying a playback mask to that cuelist or scene. Playback masking does not determine how data is recorded into a list or scene and does not change existing recorded data. Playback masking only determines which parts of the already recorded cue/scene data will be executed when that cuelist or scene is played. Follow these instructions to enable and configure playback masking for a cuelist or scene:

1. Pig + Choose : opens the options window.
2. Enable the Mask Playback button. A mask icon will now appear on the cuelist or scene in the directory window as well as on the playback bar.
3. Press the Select Playback Mask... button.
4. Select which fixture function kinds you want to enable for playback in that cuelist or scene. Kinds that are selected will play back. Kinds that are not selected will not playback.
5. Any changes made to a cuelist or scene's playback mask (including enabling/disabling the playback mask) will be reflected in output the next time that cuelist or scene is played or asserted.

17.10 Grand Master

The Grand Master inhibits the intensities of all fixtures on the console, including those within the Programmer. Parked intensities are NOT effected by the Grand Master level.

Hog and Full Boar 4 feature a dedicated grand master fader on the far left side of the console whereas Road Hog 4, HedgeHog 4, and Hoglet 4 do not have a dedicated grand master fader and utilize the fader on master 1 as a grand master fader.

The Grand Master fader can be disabled under the misc tab of the user preferences window. Disabling the grand master fader only disables the physical fader's ability to change the grand master level. The grand master level can always be adjusted by holding down the grand master display on playback bar 0 and dialing the fifth main encoder wheel (fourth main encoder wheel on Road Hog 4, HedgeHog 4, and Hoglet 4).

17.10.1 GM Key

Since the Nano Hog 4, Road Hog 4, and HedgeHog 4 consoles do not have a dedicated Grand Master fader, master 1 is utilized as the grand master. However, it is still possible to assign a cuelist or scene to master 1 which will cover the grandmaster portion of the playback bar in which case master 1 and it's corresponding fader and buttons will no longer act as a control for the Grand Master but rather as a control for the cuelist or scene assigned to master 1. In this case the grandmaster can be accessed by holding down the GM key.

The GM key's red LED indicates the state of the Grand Master:

- **Off:** Grand Master level is at 100%
- **On:** Grand Master level is at 0%
- **Slow flashing:** Grand Master level is between 1% and 99%
- **Fast flashing:** DBO is engaged

When the GM key is used in conjunction with master 1 on the console, it is possible for the position of master 1's physical fader to be different from the Grand Master's actual level. If this happens, then when the GM key is held down the Grand Master's level will be shown using a blue bar and the level of master 1's physical fader shown as a small red line. To recapture the Grand Master's level with the physical fader, move the physical fader until it is at the same level as the blue bar; at this point the fader will take control of the Grand Master level in the normal way.

Holding the PIG key while pressing the GM key acts as a virtual DBO key. When DBO is engaged the red LED on the GM key will flash quickly, the playback bar will display DBO in blue text, all intensity output will go to 0% (with the exception of parked values), and the grand master's fader level will be ignored.

17.10.2 DBO Key

The DBO key is located above the Grand Master on the Hog 4 and Full Boar 4 consoles and can be used to toggle the show between dead blackout and using the grand master's level.

The DBO key's red LED indicates it's status:

- **Off:** DBO is not engaged and Grandmaster fader has control.
- **Fast Flashing:** DBO is engaged and all fixture intensities will be restricted to 0% with the exception of parked intensities. When the DBO key is disengaged its red LED will turn off and the Grandmaster fader will regain control.

To completely disable the DBO key open the preferences window (setup → preferences) and select the Misc tab. Deselect the "enable DBO" button and press apply.



Tip

Road Hog 4, HedgeHog 4, and Nano Hog 4 do not have a dedicated DBO key, however the DBO can still be engaged/disengaged by holding pig and pressing the GM key.

17.10.3 Flash key below the Grand Master

The Flash key below the Grand Master fader is a non-latching key that can be assigned in the user preferences window to send the grand master's level to zero, to full, or to whichever value is opposing the grandmaster's current fader position.

The flash key below the grandmaster indicates the state of the Grand Master using its red LED:

- **Off:** Grand Master is at 100%.
- **Fast Flashing:** Grand Master fader is below 100%

17.11 Group Masters

Group Masters (sometimes referred to as inhibitive sub-masters) can be used to inhibit the intensity of a group of fixtures throughout the entire system. There are two types of group masters:

Physical Group Masters: created by assigning a group to a physical master.

Virtual Group Masters: groups in the group directory (not attached to a physical master on the current page). The intensity level of a Virtual Group Master is adjusted by holding down a group's cell in the group directory and dialing the fifth (or fourth) main encoder.

When a group master's level is inhibited it proportionally reduces the intensities of the fixtures within the group through the entire show (playback, editors, etc). For example, if fixtures 1-4 are in the programmer with intensities at 0%, 50%, 80% and 100%, then inhibiting a group that contains these fixtures will affect the intensity output as the fixtures as follows:

Fixture:	1	2	3	4
Group Master at 100%	0	50	80	100
Group Master at 50%	0	25	40	50
Master at 0%	0	0	0	0

Pressing the Flash key of an inhibitive master is the same as momentarily changing its fader level to 0%, taking all fixture intensities controlled by the inhibitive master to 0%. Intensity values are restored when you release the key.

Here are some important things to note about group masters:

- The group directory indicates when a group master's intensity level has been inhibited by displaying the group master's level any time it is below 100%

- If a group master's level is actively affecting fixtures on stage then a red stripe will also appear on the group master's cell in the group directory.
- Group + Release resets all virtual group masters back to 100% (remember, virtual group masters are groups that are not attached to a master on the current page).
- When the group directory is displayed in list view a location column displays the page (p) and master (m) to which an inhibited group is attached.
- By default, group master intensity levels are persisted through page changes and remain in the background as virtual group masters. To disable this feature and force group masters back to 100% once they are no longer attached to a physical master on a page, then disable the Leave Inhibitive Masters in Background option located in the Misc section of the Preferences Window.
- The release time of a group master can be adjusted in the master options window of a physical group master or by holding down a virtual group master in the group directory and adjusting the group's release time on the main toolbar.

To create a physical group master using the command line:

1. Record a group containing the required fixtures. See *Recording Groups* (p.177).
2. Group [**group number**] Move Choose

The Playback Bar will show the group name above the chosen master. When the master level is less than 100%, the Playback Bar will also display a bar showing the level. When the Flash key is pressed, the Playback Bar will display BO; see *Figure 17.11, "The display of Group Masters on the Playback Bar"*.

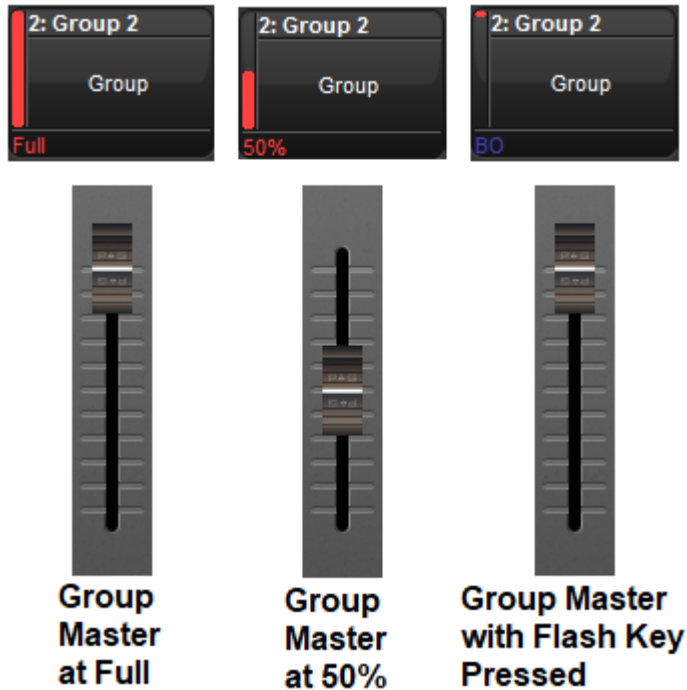

Figure 17.11. The display of Group Masters on the Playback Bar

17.12 Batches

A batch is a playback object that is used to send playback and fader messages to a collection of lists and scenes. Batches are stored in the batch directory (Pig + Open + List) and can be assigned to the playback bar like any other playback object.

17.12.1 Creating Batches

Batches are created by moving multiple lists and/or scenes to a master on the playback bar or to a batch cell in the batch directory window.

To create a batch on the playback bar:

- List or Scene, #, +, #, Move, Choose

**Tip**

To create a single item batch on the playback bar use the list/scene number twice in the move operation. For example: List, 1, +, 1 Move, Choose creates a batch that only contains list 1.

To create a batch in the batch directory:

- List or Scene, #, +, #, Move, then press an empty cell in the batch directory window (the batch directory window can be opened by pressing Pig + Open + List)

17.12.2 Modifying Batch Contents

To add a list or scene to an existing batch on the playback bar:

- List or Scene, #, Move, then press the choose key for an existing batch on the playback bar.

To add a list or scene to an existing batch in the batch directory:

- List or Scene, #, Move, then press an existing batch cell in the batch directory.

To remove a list or scene from an existing batch on the playback bar:

- List or Scene, #, Move, Move, then press the choose key for the batch you wish to remove the lists/scene from on the playback bar.

To remove a list or scene from an existing batch in the batch directory:

- List or Scene, #, Move, Move, then press an existing batch cell in the batch directory.

**Tip**

When the move key is pressed twice the command line will change from "move to" to "remove from".

17.12.3 Using Batches

When a batch's physical controls are manipulated, the commands mapped to those controls will be sent to all of the lists/scenes assigned to the batch. For example, if a batch is assigned to master 10 and its fader is assigned to Scale Playback, then moving the fader on the batch master will scale the playback of all the lists/scenes assigned to the batch regardless of the individual fader assignments for each list/scene.

17.12.4 Capturing

When dealing with simple batch commands such "go" and "release", batch execution is pretty easy to understand as all member of the batch will simply perform the command. However, when it comes to variable parameters such as intensity or playback scaling, it is possible that one or more of the lists/scenes assigned to the batch may differ from the batch's physical level. The default behavior of a batch is to not change the level of the list/scene until the batch's level has moved through (captured) the level of the assigned list/scene. In some cases it might be desirable to immediately capture the level all of the lists/scenes assigned to the batch without needing to move through their level. To accomplish this hold the PIG key while moving the fader of the batch.

17.12.5 Batch Master LED Feedback

The led feedback for a batch assigned to a physical master is exactly the same as if any single list or scene was assigned to the master, however, the batch will account for the highest running state of all the lists/scenes assigned to it. For example, if 1 out of 4 of the lists assigned to a batch are cross-fading then the green play LED will illuminate on the batch. The play LED will not turn off until all lists within the batch are finished cross-fading.

17.12.6 Batch Master Playback Bar Feedback

When a batch is assigned to a physical master the batch's number and name are displayed at the top of the master. The lists and scenes assigned to the batch are displayed inside the master. Scenes are indicated by a lowercase "s" preceding the scene number. The state of each list/scene is indicated by the background color of its cell.

In the figure shown below Batch 1 is displayed on the playback bar. List 11 and scene 33 are assigned to the batch as they are shown inside the master. Based on the background of each cell we can see that list 11 is running and scene 33 is onstage but not cross-fading.

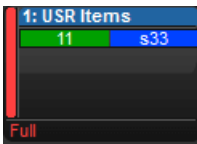

Figure 17.12. Batch Example



Important

Lists and scenes are displayed inside batch masters according to the order in which they were added to the batch. This is also the order in which the lists and scenes are internally executed by batch. Since "latest takes precedence", this means that if list 1 is assigned to a batch after list 2, and both are of equal priority, then list 1 will stomp any overlapping fixture parameters also being controlled by list 2.

Section 18: Pages

18.1 How Pages Are Used

Pages allow you to predefine layouts of cuelists, scenes and group masters, so that they can be loaded quickly on to the available playback masters.

For a concert, for example, cuelists can be organized in one page per song, so that before each performance it is possible to re-arrange the pages to reflect the current running order of the songs. One cuelist can be used several times within a page or on several pages, or it can be unique to a specific page. A template page can define certain masters to be the same on every page.

18.2 Creating a New Page

Selecting a page that currently does not exist will automatically create a blank page and load it onto the masters. Cuelists, scenes and group masters can then be assigned to the masters on the newly created page.

To create a new page:

1. Open **+ Page** : opens the Page Directory.
2. Make sure that **Guard** is not selected in the Page Directory, otherwise you will not be able to create a new page using this method.
3. Press a button in the Page Directory where you want to create the new page. A new, blank page is created.
4. Set **[name] Enter** : name the page.

Or, using the command line:

1. Page **[number] Enter** : a new, blank page is created.
2. Set **[name] Enter** : name the page.



Important

When you create a new, blank page, it is automatically loaded onto the physical playback masters. By default, any cuelists, scenes and group masters that were previously loaded will be released, and their contents will no longer be output from the console. You can change this behaviour; see *Options When Changing Page* (p.336).

18.3 Changing Page

Changing the page loads a different set of cue lists, scenes and/or group masters onto the physical playback masters. You can do this in several ways:

- Press the Next Page key to go to the next page in the Page Directory. To go to the previous page hold Pig and press Next Page.
- Using the command line : Page [**number**] Enter.
- Select the desired page from the Page Directory window. Check that the Guard button in the directory window is not selected.
- Use a macro within a cue list; see *Macros* (p.399).
- Set a trackball key to select the next page; see *Trackball Keys* (p.97).

The current page is shown in the status area at the right hand end of the Command Line Toolbar:

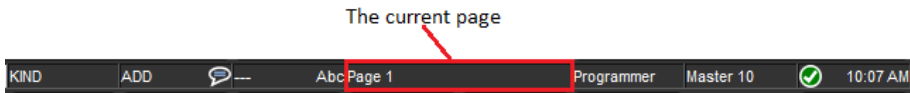

Tip

You can control which page loads next when you use Next Page to change pages by having the pages in the desired order in the Page Directory. See *Copying and Moving Pages* (p.341).

18.3.1 Options When Changing Page

The actions a console takes when the current playback page is changed can be found under the Misc tab of the User Preferences window. Listed below are descriptions of those options:

- **Release All:** cue lists, scenes, and batches attached to masters will be released when the page is changed.
- **Hold Over If Active:** active cue lists, scenes, and batches will remain active, continue to be displayed on the playback bar, and will be decorated with a pin icon. Held-over masters remain on the playback bar until you release them at which time they are replaced by the new contents of the master on the current page.
- **Leave In Background:** active cue lists, scenes, and batches will remain active in the background when the page is changed.
- **Remember intensity values:** When this option is enabled the master intensity value of cue lists, scenes, and batches are persisted through

page changes and releases. When this option is disabled cuelists, scenes, and batches will individually revert their master intensity values to 100% when they are released.

- **Remember scale values:** When this option is enabled scaling adjustments made to the playback rate, effect rate, and effect size of cuelists and scenes are persisted through page changes and releases. When this option is disabled, scaling adjustments are individually extinguished when a cuelists, scene, or batch is released.
- **Leave Inhibitive Masters in Background:** When this option is enabled the intensity value of all group masters (both virtual and physical) will persist through page changes. When this option is disabled the intensity value of physical group masters will revert to 100% when a page change results in a group master no longer being present on a physical master.

The default preferences for new shows files are Release All and Leave Inhibitive Masters in Background on page changes. To change these settings in the User Preferences window:

- Setup → Preferences → Misc : see Figure 18.1, “The Misc pane of the User Preferences window”.

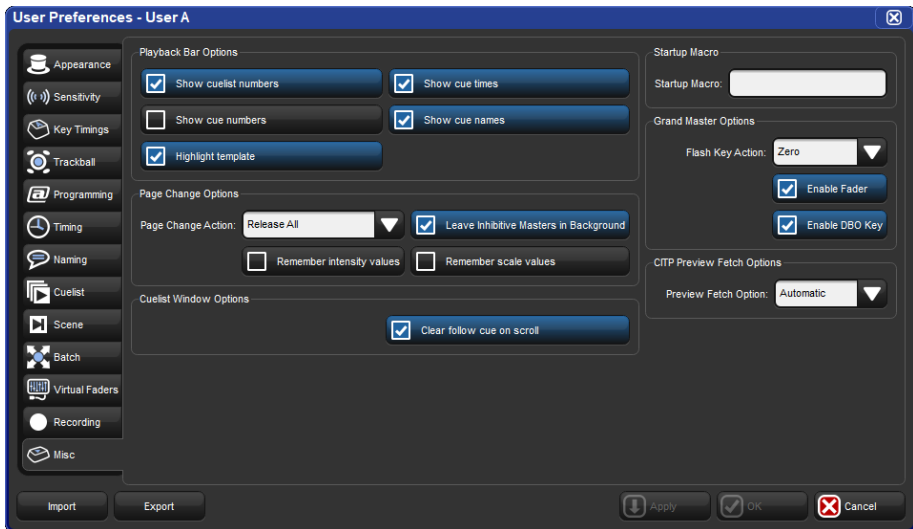

Figure 18.1. The Misc pane of the User Preferences window

To manually hold over a cue list, scene, or group assigned to a physical master when changing pages, hold the physical master's Choose key when changing the page.

To remove a held over master simply release it.

18.3.2 Matching Levels When Changing Page

When you change page using Leave In Background, it is possible for the actual position of the physical master faders to be different to the stored master level of the cuelist. For example, if you have the physical fader at 100% while on Page 1, then go to Page 2 and reduce the physical fader to 50%, and then go back to Page 1 the console must resolve the difference between the stored value of the master and the new physical position of the fader ; see Figure 18.2, "Matching Levels when Changing Page". If this situation happens on a Hog 4 or Full Boar 4 console the built-in motorized faders will automatically adjust themselves to match the master's stored level. Console such as the Road Hog 4 and Nano Hog 4 that do not feature motorized faders or for connected wing hardware that does not feature motorized faders, the master level of the cuelist will be shown on the Playback Bar in blue, together with a red dot showing the physical fader position. This state is known as having the fader "unlocked". To "relock" (rematch) the levels, move the fader until it is at the same level as the blue bar; at this point the fader will take control of the cuelist master level in the normal way.

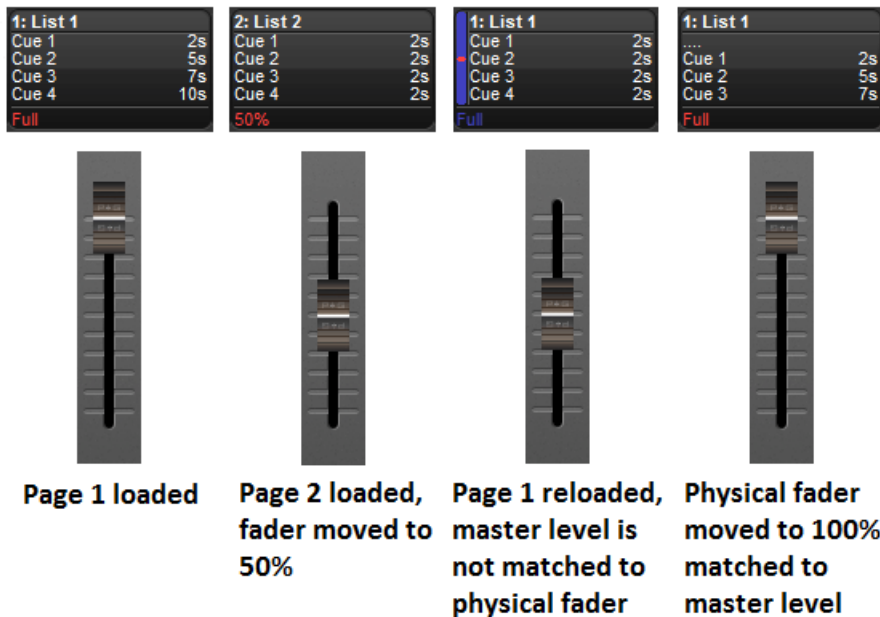

Figure 18.2. Matching Levels when Changing Page

18.3.3 Restoring Activity When Changing Pages

You can trigger cues to go and assign masters to specific fader levels when changing page by using Restore Activity. To do this, you capture the desired activities as a macro, which is later executed when the page is loaded.

To capture page activity:

1. Page + Open : open the Page Directory.

2. Go to the desired page, and assign the page activity: you can playback cuelists and scenes, and set fader levels. For example, Master 1 Go, Master 4 at 50%, Master 8 at 25%.
3. Select Capture Activity from the Page Directory to store the activity as a macro for the page.

To directly edit a page's macro:

1. Page + Open : open the Page Directory.
2. Select  to change to the spreadsheet view.
3. Select the Macro cell and press the Set key. Type in the macro you require, and press Enter.

For details of the macro syntax, see *Macros* (p.399).



Tip

You can display a list of available macro commands on the console by selecting the Macro cell and pressing the Set key.

To clear the macro:

1. Page + Open : open the Page Directory.
2. Deselect  to change to the button view.
3. Right click on the page and select Clear Activity Macros from the contextual menu.

Similarly, you can enable or disable Restore Activity without deleting the macro itself by right clicking on the page and selecting from the contextual menu. A



icon will appear as a reminder that Restore Activity is on.

18.4 Modifying Pages

You can copy or move cuelists, scenes and group masters to a page, or remove them, as well as clearing the whole page. If you change which cuelists, scenes or group masters are assigned to the current page, then that assignment will automatically be recorded

as part of the page. Changes made to cuelists, scenes and group masters (such as editing their contents) remain with that item, and not with the page.

18.4.1 **Copying Lists, Scenes and Group Masters to a Page**

Copying a cuelist to a page creates a new cuelist which is independent of the one it is a copy of. Any changes made to this new cuelist will not effect the original cuelist. To copy an existing cuelist to a page:

- List 2 Copy Choose : copies cuelist 2 to the selected master.

You can also copy a cuelist from one master to another:

1. Choose : press the Choose key of the master with the cuelist you want to copy.
2. Copy
3. Choose : press the Choose key of the master you want to copy the cuelist to.

You can copy scenes and group masters in the same way.

18.4.2 **Moving Lists, Scenes and Group Masters to a Page**

Moving a cuelist to a page does not create a new cuelist, so changes made to the cuelist will affect all other uses of that cuelist on other pages. To move an existing cuelist to a page:

- List 2 Move Choose : moves cuelist 2 to the selected master.

You can also move a cuelist from one master to another:

1. Choose + Move : press the Choose key of the master with the cuelist you want to move.
2. Choose : press the Choose key of the master you want to move the cuelist to.

You can move scenes and group masters in the same way.

18.4.3 **Removing Lists, Scenes and Group Masters from a Page**

To remove a cuelist, scene or group master from a page:

- Delete + Choose

Note that this will only remove the item from the master; the item will not itself be deleted from the show.

18.4.4 Clearing Lists, Scenes and Group Masters from a Page

To clear all cuelists, scenes and group masters from the current page:

1. Open + Page : opens the Page Directory window.
2. Press Clear Current Page in the Page Directory.

Note that clearing the current page will remove items from the masters; the items themselves will not be deleted from the show.



Important

When you clear the current page, any cuelists, scenes and group masters that were previously loaded onto the physical masters will be released, and their contents will no longer be output from the console.

18.5 Copying and Moving Pages

You can copy and move pages:

1. Open + Page : open the Page Directory.
2. Make sure that the Guard button is selected, otherwise pressing a directory button will activate the page, rather than just selecting it.
3. (Page 1) Copy (Page 3) : copies Page 1 to Page 3.

Similarly, using the command line:

- Page 2 Move Page 4,Enter : moves Page 2 to Page 4.



Tip

The order of the pages in the directory determines which page you get when changing pages using the Next Page key. You can copy and move your pages so that they appear in the correct order for your show. You can then go through the performance using Next Page rather than selecting from the directory.

18.6 Deleting Pages

To delete a page:

1. Page 1 Delete
2. Click OK to confirm the delete.

You can delete a range of pages:

1. Page **1** Thru **4** Delete
2. Click OK to confirm the delete.

Note that you cannot delete the current page. Deleting a page does not delete cuelists or scenes from the show.



Tip

If you prefer not to be asked to confirm the delete action, select Don't Ask Me Again in the confirmation window. You can re-enable the confirmation by going to Setup → Preferences → Programming and selecting Confirm before deleting directory items.

18.7 The Template Page

The template page specifies which cuelists will appear on specific masters for *every* page without physically having to load them onto the same masters on all pages. For example, you could have a primary cuelist containing the commonly used cues of the show, which you want available on the same master, regardless of which page you are on. When you move this cuelist to a master on the Template page, it will then appear on the same master of all pages. If a normal page and a template page have a cuelist on the same master, the normal page's cuelist will override the template page's cuelist.

To make a page into the template page:

1. Open + Page : opens the Page Directory window.
2. Right-click on the page, and select Set As Template Page from the menu.

To turn off the template page, right-click on the template page and select Clear Template Page from the menu. There can only be one template page; assigning a new template page will restore the previous one to a normal page. The template page is shown by a



symbol in the directory window.

Since the template page typically does not relate to a specific portion of your production (a song for example), template pages are never loaded from the Next Page key. When cycling through pages with this key, the template page will be skipped. You can always directly load the template page using either the page directory or the command line.

Cuelists, scenes and group masters that appear on a master of a page because they originate from the template page are shown in blue on the Playback Bar by default; see *Figure 18.3, "Playback Bar with Master 10 loaded from the Template Page"*. You can turn this off in Setup → Preferences → Misc by deselecting Highlight Template.

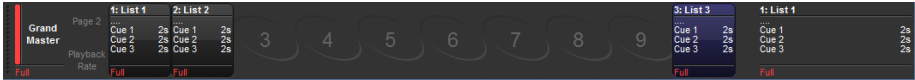

Figure 18.3. Playback Bar with Master 10 loaded from the Template Page

If the template page is the current page, the entire Playback Bar, including empty masters, are also shown in blue; see Figure 18.4, “The Playback Bar with the Template Page loaded”.

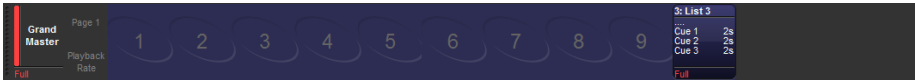

Figure 18.4. The Playback Bar with the Template Page loaded

Section 19: Command Keys

19.1 Command Key Overview

Command Keys are user-created single button executers that trigger existing show objects including palettes, groups, views, lists, scenes, and keystroke macros. Command keys are stored in the commands directory and are also accessible using the 12 function keys on the front panel of the console (when the function keys are set to command mode). To toggle the function keys between kind mode and command mode hold down **⌘** and press **Enter**. The mode of the function keys is displayed on the main toolbar (KIND / CMD). To open the command directory hold the **open** key and press the "Commands" button on the main toolbar.

19.2 Creating Command Keys

Command keys are created by using the "move" syntax of the console to assign existing show objects to empty cells in the commands directory or to blank function keys on the front panel (when the console's function keys are set to CMD mode). Please note that the original show objects are not actually being moved.

Here is an example of how to create a command key for **cue**list 1:

1. List 1
2. Move
3. Press any empty cell in the command directory or press any empty function key on the front panel (if the console's function keys are set to command mode)



Tip

When command keys are created they automatically inherit the name and color-coding of the show object that they are linked to. Changing the name or color-coding of a command key will change the name and color-coding of the show object it is linked to and vice-versa.

19.3 Copying, Moving, and Deleting Command Keys

Command keys can be copied, moved, and deleted using both the commands directory and the function keys on the front panel (when the console's function keys are set to command mode).

To delete a command key: Press and hold delete; then press a command key on the front panel or in the commands directory.

To move a command key: Press and hold move; then press a command key on the front panel or in the commands directory; after you release the move key press any empty command key on the front panel or empty cell in the commands directory.

To copy a command key: Press and hold copy; then press a command key on the front panel or in the commands directory. after you release the copy key press any empty command key on the front panel or empty cell in the commands directory.

19.4 Changing the Action of a Command Key

The action that occurs when a command key is pressed can be configured by viewing the commands directory in spreadsheet view and editing the "Action" cell.

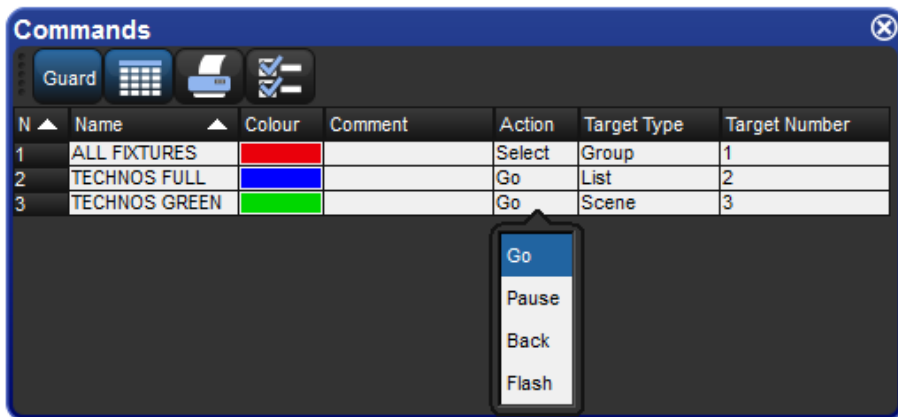

Figure 19.1. Command directory in list view; selecting an action

Not all command keys have the same action options. The list of available actions for a Command Key depends on the capabilities of the show object that it is linked to:

For Command Keys linked to Groups, Pages, Views, Keystroke Macros & IPCBE Palettes: The only available action is "Select"

For Command Keys linked to Lists and Scenes: The available actions include "Go", "Pause", "Back", and "Flash". The default action is "Go".



Tip

Holding down the PIG key while pressing a command key linked to a lists or scene will release that list or scene.

19.5 Command Key Feedback

When a command key is executed the function key associated with that command key will provide the following feedback to indicate the running state of the show object linked to the command key:

For Command Keys linked to Groups, Pages, & IPCBE Palettes: Blue LED on indicates the object is selected; Blue LED off indicates the object is not selected

For Command Keys linked to Lists, Scenes, & Keystroke Macros: Blue LED on indicates the object is onstage; Blue LED off indicates the object is not onstage (released); Fast flashing blue LED indicates the linked object is actively executing (cross-fading, running, releasing); slow flash blue LED indicates the linked object is paused

For Command Keys linked to Views: No LED feedback is provided for command keys linked to views as views are simply recalled when executed and do not have a status

The commands directory also provides feedback for the running state of the show objects linked to by the command keys.

Section 20: Plots

20.1 Introduction to Plots

Plots are user created graphical layouts that contain programable objects such as fixtures and PixelMaps. Plots can be used to select fixtures, gather fixture feedback, and apply PixelMapping values to fixtures.

Plots are stored in the plots directory. To open the plots directory window hold the Open key and press the Plots button on the main toolbar or press Pig + Open + Fixture (on the console front panel).

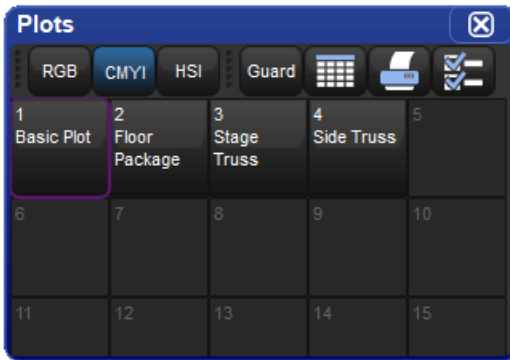

Figure 20.1. The Plots Directory

To open a plot hold the Open key and press the coordinating plot button in the directory. You can also open a plot using the command line by pressing Pig + Fixture (this will put the word plot on the command line), specifying a plot number, and then Open. For example: Pig + Fixture,1, Open will open plot 1.

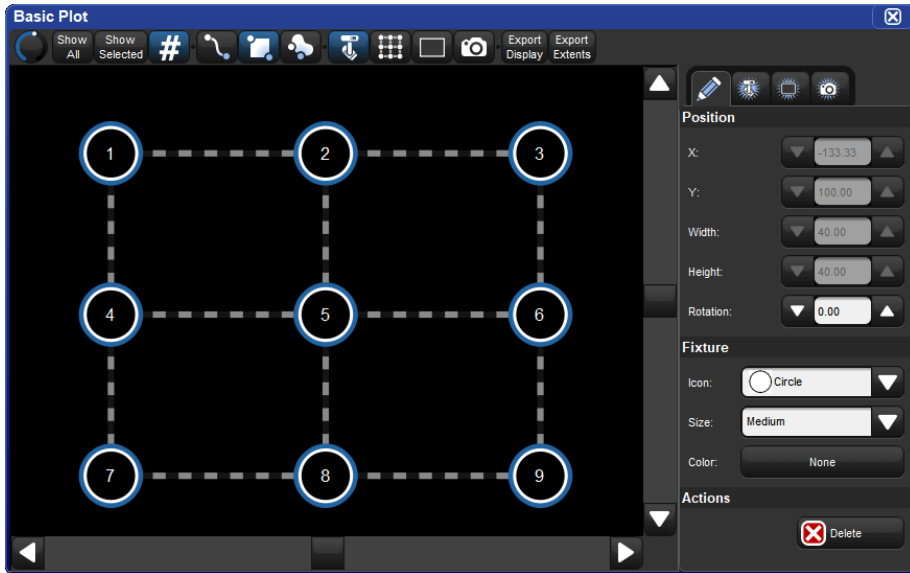

Figure 20.2. Example of a Basic Plot

20.2 Creating Plots

Plots can be created as entirely blank or pre-populated with fixtures.

To create a blank plot:

1. Ensure that no fixtures are currently selected.
2. Record
3. Pig + Fixture ("plot" should now appear on the command line after record)
4. Use the numeric keypad to enter the plot number you wish to create.
5. Enter
6. A new and entirely blank plot has now been created.

To create a plot pre-populated with fixtures:

1. Select the fixtures you want to have in your new plot.
2. Record
3. Pig + Fixture ("plot" should now appear on the command line after record)
4. Use the numeric keypad to enter the plot number you wish to create.

5. Enter
6. A new plot has now been created containing a box gang that contains all of the fixtures you selected in step 1.

NOTE: You can also use the plots directory to create a new plot by pressing on a blank directory button in the plots directory window after pressing record.

20.3 Editing Plots

All plots contain four main types of objects: fixtures, gangs, PixelMaps, and background images. In this section we will review how to add, remove, and edit these different types of objects as well as a few tricks on how to quick manipulated multiple plot objects at once.

20.3.1 Fixtures

To **add** fixtures to a plot:

1. Open the plot (Pig + Fixture, #, Open)
2. Enable the fixture edit button at the top of the plot window.



3. Click the add fixtures tab of the properties pane located on the right side of the plot window.

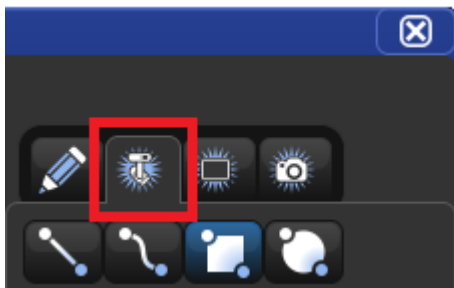

4. Use the buttons listed under the add fixtures tab to choose what type of gang arrangement you will like to use for adding the fixtures to the plot.
5. Make a fixture selection.

6. Drag your finger across the plot window to add the fixtures (or click and drag using the trackball/mouse)
7. The fixtures are now added to the plot using the gang type you selected.

To **remove** fixtures from a plot:

1. Enable the fixture edit button at the top of the plot window
2. Select the fixtures in the plot you wish to remove (fixture selection can either be done directly in the plot window or by using the command line or groups)
3. Press the Delete button in the properties pane located on the right side of the plot window.

To **edit** a fixture (change its properties):

1. Enable the fixture edit button at the top of the plot window.
2. Select the fixture(s) you wish to edit.
3. Use the properties pane located on the right side of the plot window to adjust the fixture's position and/or rotation, icon type/size, and color-coding. You can also reposition a fixture by using the mouse or touchscreen to click and drag the fixture into position. Note: fixtures that are attached to gang must first be detached (dragged off the gang) in order to be custom positioned. Also be aware that changing the icon or color-coding for a fixture in one plot will change the assigned icon and color-coding for that fixture in all plots as this property is shared show-wide.

20.3.2 Gangs

Gangs are collections of fixtures arranged in geometrical shapes. Gangs themselves can be resized and rotated. Gangs also feature several options for how the fixtures contained with the gang are ordered. In this section we will review how to edit gangs, add/remove fixtures from gangs, and delete gangs.

To **remove** a gang:

1. Enable the gang edit button at the top of the plot window.



2. Select the gang you wish to delete.
3. Press the Delete button in the properties pane located on the right side of the plot window; the gang and all the fixtures attached to it will be deleted from the plot.

To **edit** a gang (change its properties):

1. Enable the gang edit button at the top of the plot window.
2. Select the gang you wish to edit.
3. Use the properties pane located on the right side of the plot window to adjust the gang's position, size, fixture layout, fixture ordering, etc...). You can also reposition the gang by using the mouse or touchscreen to click and drag the gang into position. Similarly, you can resize and rotate the gang using the blue object handles that appear when the gang is selected (circle handle for gang rotation / square handle for gang sizing).

20.3.3 PixelMaps

PixelMaps are rectangular plot objects which can be used to map the pixels of rich media content (photos and videos) onto lighting fixtures through a process known as PixelMapping. In this section we will discuss how to add/remove PixelMaps in plots. For more detailed information on PixelMapping refer to section 20.4.

To **add** a PixelMap:

1. Enable the PixelMap edit button at the top of the plot window



2. Click on the add PixelMap tab of the properties pane located on the right side of the plot window

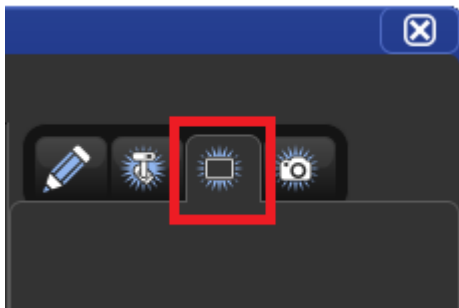

3. Touch (or left click) and drag across the plot window to draw a pixel map

To **remove** a PixelMap:

1. Enable the gang edit button at the top of the plot window.
2. Select the gang you wish to delete.

3. Press the Delete button in the properties pane located on the right side of the plot window.

To **edit** a pixelmap (change its properties):

1. Enable the PixelMap edit button at the top of the plot window.
2. Select the PixelMap you wish to edit.
3. Use the properties pane located on the right side of the plot window to adjust the PixelMap's position, size, rotation, and layer assignments). You can also reposition the PixelMMap by using the mouse or touch-screen to click and drag the PixelMap into position. Similarly, you can resize and rotate the PixelMap using the blue object handles that appear when the PixelMap is selected (circle handle for gang rotation / square handle for gang sizing).

20.3.4 Background Images

Background Images are rectangular plot objects which can be used to display photos in the background of the lighting plot. Supported formats for background images include JPG, PNG, BMP, and TIFF. In this section we will discuss how to add/remove and edit background images in plots. For more detailed information on PixelMapping refer to section 20.4.

To **add** a background image to a plot:

1. Enable the background image edit button at the top of the plot window.



2. Click on the add background image tab of the properties pane located on the right side of the plot window.

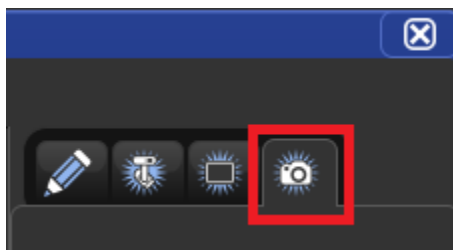

3. Touch (or left click) and drag across the plot window to draw a background image rectangle.

To **remove** a background image:

1. Enable the background image edit button at the top of the plot window.

2. Select the background image you wish to delete.
3. Press the Delete button in the properties pane located on the right side of the plot window.

To **edit** a background image (change its properties):

1. Enable the background image edit button at the top of the plot window.
2. Select the background image rectangle you wish to edit.
3. Use the properties pane located on the right side of the plot window to adjust the background image's position, size, rotation, fill color, border color, and image assignment. You can also resize and rotate the background image using the blue object handles that appear when the background image is selected (circle handle for rotation / square handle for sizing).

Assigning a fill image

To assign a fill image for an image rectangle:

1. Enable the background image edit button at the top of the plot window.
2. Select a background image rectangle to edit. (If one doesn't exist then create one using the steps list in the previous section).
3. Press the "select" button in the properties pane for the "image" attribute.
4. An Image File dialogue box will appear. Select an image from the list of images and press okay. If images are not listed in the Image File dialogue box then proceed to *Importing Background Images from a USB Flash Drive* (p.356) for details on how to import images into the show.

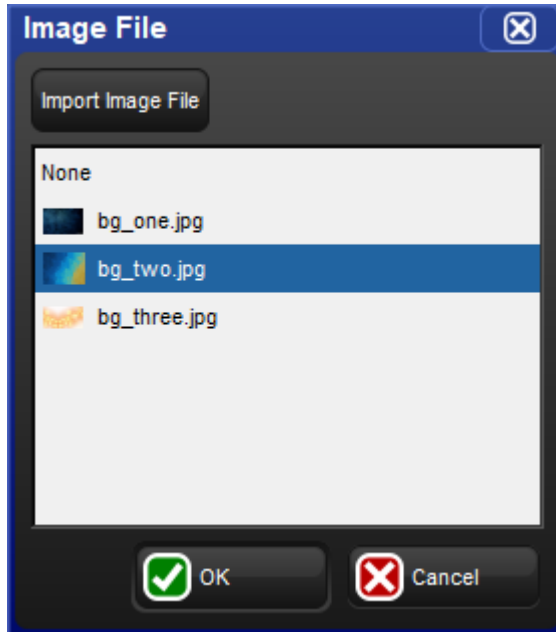

Importing Background Images from a USB Flash Drive

To import an image file from a USB Flash drive into the background image file list:

1. Use a personal computer to copy the image file you wish to import to an external USB flash drive.
2. Insert the USB flash drive into the console.
3. Click on the "Import Image File" button at the top of the Image File dialogue box.

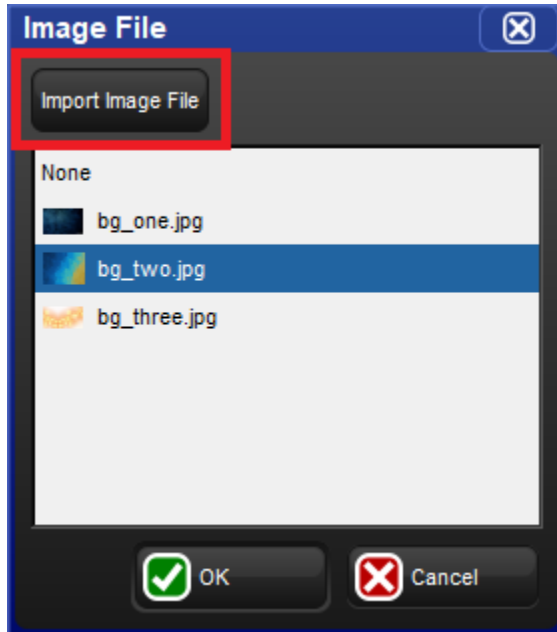

4. Browse to the external USB flash drive and select an image to import. Press okay to confirm.
5. The image has now been imported and is available for assignment to image rectangles for all plots in the show unless the image is manually deleted using the right click menu in the Image File dialogue box.

20.3.5 Tips for editing multiple plot objects

This section will cover some handy shortcuts and tips for editing multiple plot objects at once. These tips can help you to build complex plots more quickly and symmetrically.

To **equalize** the properties of multiple plot objects:

1. First select a plot object that has a property value that you want to apply to other objects in the plot (for example, you may want to align objects to have the same X position as one of the objects already in the plot)
2. Now select the plot objects you wish to adjust to match the first plot object you selected
3. Hold the / key on the front panel of the console
4. Press the up or down scroll button for the property you want to equalize all the selected objects to (for example, if you want all the selected plot objects to align horizontally then press the up or down arrow button for the X position property while holding the / key)

20.4 Using Plots

Plots can be used to accomplish a variety of important programming tasks. In this section we will review how to make simple and complex fixture selections using the plot window, how to navigate the plot window, and how to use the plot window to quickly view feedback for fixtures.

20.4.1 Fixture Selection

Fixture selections made in plots are sent to the current active editor and can be used in conjunction with command line and group directory fixture selections as well. In this section we review the selection tools available in the plot window and the plot window fixture selection syntax.

There are three selection tool buttons at the top of the plot window. These tools can be used for selecting fixtures when programming looks and also for selecting fixtures, gangs, and PixelMaps when editing plots:

	Path Selection Tool: selects fixtures by drawing a line through the fixtures you wish to select	Based on the order in which fixtures are touched by the line as you draw it.
	Rectangle Selection Tool: selects fixtures by drawing a rectangle around the fixtures you wish to select. Any fixture that is entirely inside the rectangle will be selected. If a fixture is only partially inside the rectangle it will not be selected.	Fixtures inside the selection rectangle are selected in the order in which they are touched.
	Lasso Encompassing Selection Tool: selects fixtures by drawing a free form circle around the fixtures you wish to select. Any fixture that is entirely inside the lasso will be selected. If a fixture is only partially inside the lasso it will not be selected.	Fixtures inside the selection lasso are selected in order in which they are touched.

Plot window fixture selections follow many of the same rules as the selections made using the command line. The syntax for selecting fixtures in plots is as follows:

- Fixture selections made in a plot are added to the current fixture selection until an edit is made. Once an edit is made, such as adjusting pan/tilt, then a new fixture selection is started.
- Holding the + key while selecting fixtures in a plot adds those fixtures to the current fixture selection.
- Holding the - key while selecting fixtures in a plot removes those fixtures from the current fixture selection.
- Tapping on an a fixture that is already selected will deselect the fixture.

20.4.2 Navigation (zoom/scroll)

Plots are 2-dimensional layouts that can be zoomed and scrolled to ensure good visibility and easy selection.

There are three main ways to **zoom** in and out of the plot window:

1. Use the zoom tool at the top left hand corner of the plot window.
2. Hold Open and turn the third encoder wheel on the front panel.
3. Hold Open and turn the trackball ring.

There are three main ways to **scroll** the plot window horizontally and vertically:

1. Use the scroll bars in plot window.
2. Hold Open and turn the first and second main encoder wheels on the front panel.
3. Hold Open and move the trackball up/down/left/right.

20.4.3 Feedback

The plot window provides feedback for the fixtures in the plot in terms of intensity and mixed color (CMY, HS, RGB).

Note: Slotted colors, gobos, and other media are not yet supported in the plot feedback system.

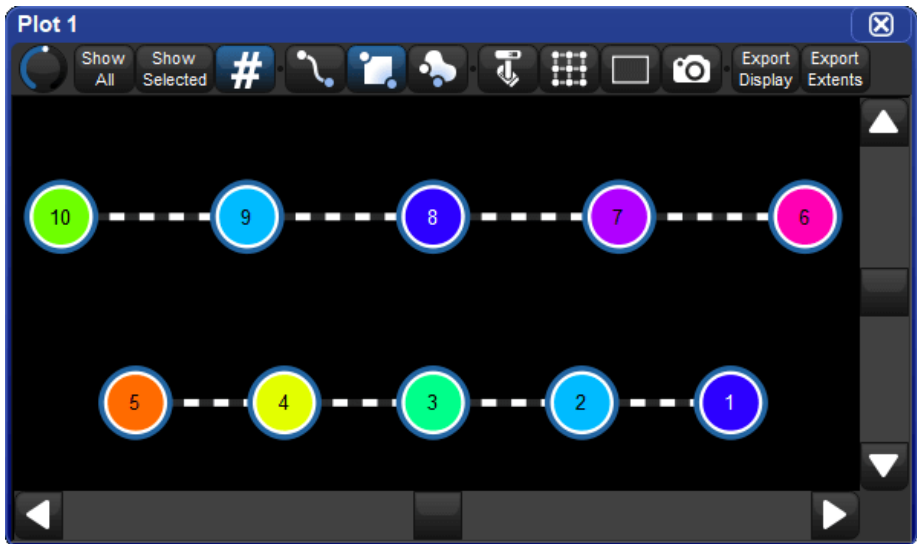

Figure 20.3. Example of Plot Window with Feedback

20.4.4 Show/Hide Fixture Numbers

The user numbers displayed inside of fixtures in a plot window can be shown/hidden by toggling the # button at the top of plot window. The show /hide number setting is stored per plot window and is persisted in views.



20.4.5 Exporting Plots

There are two buttons at the top of a plot window that allow you to export the plot:

- **Export Display:** generates an image file (.PNG) of the current plot view (similar to print screen).
- **Export Extents:** generates a vector graphics file (.SVG) file of the entire plot.



20.5 PixelMapping

One of the more complex objects that can be added to a plot is a PixelMap. A PixelMap allows the fixtures inside of it to dynamically change their parameter values based on the PixelMap Layer content being sent to the PixelMap. This process is called PixelMapping. Section 20.2.3 covers how to add and remove PixelMaps in a plot. In this section we will discuss how to add and assign PixelMap Layers to PixelMaps, how to program fixtures to use PixelMap values, and how to manage PixelMap Layer content.

20.5.1 PixelMap Layers

PixelMaps are responsible for mapping media content onto lighting fixtures, but, they do not supply the media content themselves. The content comes from programmable fixtures known as PixelMap layers, which are added to the show using the fixture window. Once added to the show PixelMap layers are then assigned to PixelMaps.

To add a PixelMap layer fixture to the show:

1. Open the patch window.
2. Click on the fixture schedule button.

3. Look under the "Hog" manufacturer for a fixture called "PixelMap Layer"
4. Use the count column to specify how many PixelMap layer fixtures you want to add to the show.
5. Click OK on the fixture schedule window.

To assign a PixelMap Layer fixture to a PixelMap:

1. Open the plot containing the PixelMaps to which you wish to assign PixelMap layers.
2. Enable the PixelMap edit button at the top of the plot window.
3. Select a PixelMap in the plot.
4. Locate the "Pixel Map" section of the properties tray located on the right hand side of the plot window.
5. Under the text label "Layer fixture patch" you will see all of the PixelMap layers scheduled in the show.
6. Select the layers to assign them to the pixel map.

IMPORTANT NOTE: Regardless of the user numbers you assigned to the PixelMap layers, they are layered onto PixelMaps using the order in which you select them in step 6. Layer order is important when working with multiple layers as Z position is not adjustable: High numbered layers will always appear on top of low numbered layers.

20.5.2 Programming lighting fixtures to use PixelMaps

PixelMaps are applied to fixtures very similar to how IPCB palettes are applied to fixtures.

To assign a fixture's parameters to a PixelMap:

1. Make a fixture selection
2. Open the plots directory (Plg + Open + Fixture)
3. At the top of the plots directory choose which fixture parameters you wish to pixelmap (RGB, CMYI, HSI)
4. Select a plot from the plot directory (be sure to choose a plot in which the currently selected fixtures are plotted inside a PixelMap)
5. The parameter values of the current fixture selection are now assigned to the plot in the editor. This means that those fixture values will now be determined by the content being passed into the PixelMaps in that plot.
6. Now select and program the PixelMap layers assigned to the PixelMaps in the referenced plot.

**Caution**

Deleting a plot automatically removes any references to that plot in all existing cues and palettes.

20.5.3 Programming PixelMap Layers

PixelMap Layers are used to send media content to PixelMaps which are then output to the mapped lighting fixtures. In the previous section we discussed how to program lighting fixtures to listen to PixelMaps. In this section we will discuss how to program the PixelMap layers to output content to the PixelMaps they are assigned to.

To program a PixelMap Layer:

1. Select a PixelMap Layer by entering its user number in the command line and pressing Enter.
2. Adjust the intensity parameter to the desired level.
3. Choose a media folder and media file using the encoder wheels or the Media Picker window (Pig + Open + Beam opens the media picker window).
4. The PixelMap layer will now output the selected content to the PixelMaps it is assigned to.
5. Use the other programmable parameters of the PixelMap Layer fixture such as scaling, position, rotation, effects, and play speed to create dynamic and interesting pixelmapping output.

20.5.4 PixelMap Layer Effects

Pixelmap layers can be programmed using the following effect mode and effect modifier parameters which are located under the color kind:

Transparent Black (mod 1 = grayscale select, mod 2 = transparency level, mod 3 = tolerance)

Transparent White (mod 1 = grayscale select, mod 2 = transparency level, mod 3 = tolerance)

Transparent Color (mod 1 = hue select, mod 2 = saturation select, mod 3 = tolerance)

Tiling (mod 1 = x axis, mod 2 = y axis, mod 3 = z axis)

Note: these effects are only available when using revision 3 or greater of the PixelMap Layer fixture type in the fixture library.

20.5.5 Managing PixelMap Layer Content

A PixelMap layer is a programmable fixture that supplies media content to PixelMaps. When a PixelMap layer fixture is added to a show a small collection of stock media content is also added to the show's PixelMap Content Package. The PixelMap Content Package is shared by all PixelMap layers in the show and is organized using a folder and file structure similar to how many standalone media servers store content.

Adding custom content to the PixelMap Content Package is easy. In this section we will review how to import media into the PixelMap Content Package, how to assign dmx values to the folders and files in the PixelMap Content Package, which file types are supported for import, and how to choose and optimize content to ensure smooth play-back and effective visual representation.

Importing Custom Media to the PixelMap Content Package

The PixelMap Content Package supports up to 255 folders which can contain up to 255 media files each. All custom media added to the PixelMap Content Package is stored in the show file and is included in show file backups.

To add custom media content to the PixelMap Content Package:

1. Put the custom content you wish to import into the show onto a USB Flash Drive.
2. Insert the USB Flash Drive into one of the console's USB ports.
3. Open the shows window on the console (Press Setup key on front panel and select Shows from the main toolbar).
4. Select the PixelMap Content tab of the shows window. On the left hand side of the window you will see a normal file browser where you can access files and folders on both the internal hard drive as well as on external drives such as USB flash drives. On the right hand side of the window is a browser that allows you to see the contents of the PixelMap Content Package. (Note: If the PixelMap Content tab doesn't show up in the shows window then you have not yet scheduled a PixelMap layer in your show and will need to do so first).
5. Create a new folder in the PixelMap Content Package by clicking on the new folder icon at the top of the window or by right clicking in the browser and selecting "new folder".
6. Give the folder a dmx address assignment by right clicking on the folder and selecting "renumber". Enter a numeric value and confirm by pressing Enter.
7. Use the browser on the left hand side of the window to locate media stored on the external USB flash drive that you inserted into the console in step 2.
8. Drag and drop the media files you wish to import from the USB flash drive into the folder you created in step 6. Hold pig to select multiple files. You can also drag entire folders of content from the USB Flash

Drive to the PixelMap Content Package as long as the folder you are importing does not contain sub-folders.

9. All files imported into the PixelMap Content Packages are automatically assigned a dmx address. To manually change the dmx address assignment of a file in the PixelMap Content Package right click on the file and select "renumber". Enter a numeric value and confirm by pressing Enter.

Note: If you wish to have more control over how the console auto-assigns dmx addresses to files during import, then simply prefix the names of the folders and files you are importing with a three digit number that coincides with the desired dmx address value. For example, if you import a file named "023 BigBird.png" it will automatically be assigned a dmx address value of 23.



Caution

Any folders or files in the PixelMap Content Package that do not have a dmx address assignment will still show up in the media picker window but will not be selectable for output.

File Types Supported for PixelMap Content Package Import

The following file types have successfully been tested and are supported for import into the PixelMap Content Package:

Image Formats

- JPEG
- PNG
- TIFF
- BMP
- GIF (only first frame of animated GIFs will be imported)

Video Formats

- H.264
- MPEG-4 Part 2
- MPEG-2
- Cinepack
- Windows Media Video

Choosing and Optimizing PixelMapping Content

When media content is imported into the PixelMap Content Package it is automatically optimized for playback in the PixelMap layer, however certain measures should be

taken when choosing and preparing content for import to ensure a more reliable import, smoother playback, and effective mapping. Here are some basic tips for choosing and preparing content for import:

Images:

- Even though high resolution content can be imported most of the resolution is thrown away during import. For faster import conversion it is best to use lower resolution image files.
- Remove black pixels from images in favor of transparency and save image as PNG; this will give you more flexibility when using multiple layers in a single PixelMap.
- Avoid images that feature complex objects such as faces, logos, or text unless you are using a very dense grid of target fixtures in your PixelMap.

Movies:

- Trim videos to 60 seconds or shorter in length (longer videos will get cut off at 60 seconds).
- Choose videos that loop seamlessly.
- Choose video files with frame rates of 30 fps or less and that have a high number of key frames.
- Even though most HD (1080p and 720p) video content can be directly imported to the PixelMap Content Package most of the resolution is thrown away during import. For faster conversion during import it is best to use lower resolution video files such as 352×240 (Video CD) or 720×480(DVD).
- Avoid using video files that feature complex objects such as faces, logos, or text unless you are using a very dense grid of target pixel fixtures to display this content.

Section 21: MIDI

21.1 MIDI Show Control

MIDI Show Control (MSC) is supported on every console in the Hog family including Hog 4PC. Midi Show control allows you to control the basic playback functionalities of the Hog 4 OS from other MSC enabled consoles or from a Midi Show Control output device such as a personal computer running show control software.

21.1.1 Bringing MSC into the Console

To bring MSC into a Hog Console:

1. Connect the output of an MSC device to the MIDI In port on the back of the console. (If you are using an external USB Midi device such as a USB keyboard or an external USB Midi Widget to send MSC into the console, connect the USB connection of your external USB midi device to one of the USB ports on your console. Please note that only generic "USB MIDI Class" devices are supported by the consoles. USB midi devices that require proprietary drivers may work with Hog 4 PC as long as the specific driver is installed on the Windows machine but these types of USB devices that require specific drivers will not work with Hog 4 OS consoles.)
2. Setup → Control Panel : Navigate to the midi tab of the control panel. If you are using the console's built in midi input port then make sure **USB LTC Midi 1** is selected as the midi input device. If you are using a USB Midi device such as a USB keyboard or external USB Midi widget to bring MSC into the console then select that device from the input drop down menu.
3. Setup → Network : open the Network window.
4. Select the console in the list.
5. Settings : open the Settings window; see *Figure 21.1, "The Midi Show Control pane of the Console Settings window"*.
6. In the MIDI Show Control pane, check MSC In.

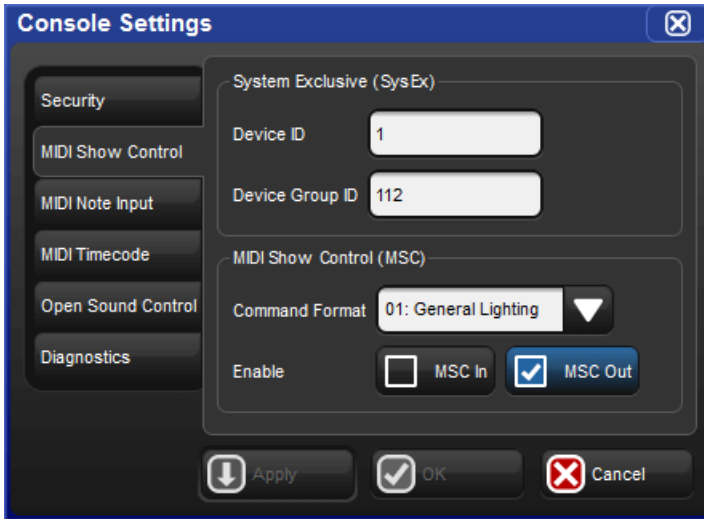

Figure 21.1. The Midi Show Control pane of the Console Settings window



Tip

You can selectively disable MSC input for individual cuelists or scenes by enabling the "Ignore MSC In" option in the options window.

21.1.2 Sending MSC from the Console

To send MSC from a Hog Console:

1. Connect the input of an MSC device to the Midi OUT port on the back of the console. (If you are sending MSC output directly to a USB Midi device such as a third party control system then connect the USB connection of that external USB midi device to one of the USB ports on your console. Please note that only generic "USB MIDI Class" devices are supported by the consoles. USB midi devices that require proprietary drivers may work with Hog 4 PC as long as the specific driver is installed on the Windows machine but these types of USB devices that require specific drivers will not work with Hog 4 OS consoles.)
2. Setup → Control Panel : Navigate to the midi tab of the control panel. If you are using the console's built in midi output port for MSC output then make sure **USB LTC Midi 1** is listed and selected as the midi output device. If you are outputting MSC directly to a connected USB device then select that device from the output drop down menu.
3. Setup → Network : open the Network window.
4. Select the console in the list.
5. Settings : open the Settings window.

- In the Midi Show Control pane, check MSC Out.

**Tip**

You can selectively disable MSC output for individual cuelists or scenes by enabling the "Suppress MSC out" option in the options window.

21.1.3 Using MIDI Show Control

Hog 4 OS recognises and sends the following MSC commands:

Hog 4 OS Command	MSC Command	MSC Data
Go	0x1 GO	cue number, cueлист number
Halt	0x2 STOP	cueлист number
Resume	0x3 RESUME	cueлист number
Skip Forward	0x4 TIMED_GO	time=0, cue number, cueлист number
Skip Back	0x4 TIMED_GO	time=0, cue number, cueлист number
Release	0xb GO_OFF	cueлист number
Change Page	0x1d OPEN_CUE_PATH	page number

MIDI show control is enabled by default for all cuelists and scenes. You can assign a cueлист or scene to ignore incoming MIDI Show Control commands:

- Open + Choose → Options → Cueлист
- Select Ignore MSC In.

Similarly you can prevent the MIDI Show Control commands for a cueлист being sent out from the console:

- Open + Choose → Options → Cueлист
- Select Suppress MSC Out.

**Tip**

MSC doesn't distinguish between cues and scenes as Hog 4 OS does, so there are no MSC commands to control scenes. To work round this, you can send an MSC command with a CUE_PATH value of 5. Hog 4 OS will treat the cue number as a scene number instead.

21.2 MIDI Note Input

MIDI Notes is a common language of the well-established MIDI standard that can be used to control console features such as Programming buttons, Playback buttons, Touch

Screen Soft Keys, and Comment Macros. Each of these feature categories uses a specific MIDI map to associate notes with console functions.

To bring MIDI Notes into the console:

1. Connect a MIDI device to the MIDI In port on the back of the console. (If you are using a USB Midi device such as a USB keyboard or an external USB Midi Widget to send Midi Notes into the console then connect the USB connection of your external USB midi device to one of the USB ports on your console. Please note that only generic "USB MIDI Class" devices are supported by the consoles. USB midi devices that require proprietary drivers may work with Hog 4 PC as long as the specific driver is installed on the Windows machine but these types of USB devices that require specific drivers will not work with Hog 4 OS consoles.)
2. Setup → Control Panel : Navigate to the midi tab of the control panel. If you are using the console's built in midi input port to bring Midi notes into the console then make sure **LTC Midi 1** is listed and selected as the midi input device. If you are using a USB Midi device such as a USB keyboard or external USB Midi widget to bring Midi notes into the console then select that device from the input drop down menu.
3. Setup → Network : open the Network window.
4. Select the console in the list.
5. Settings : open the Settings window.

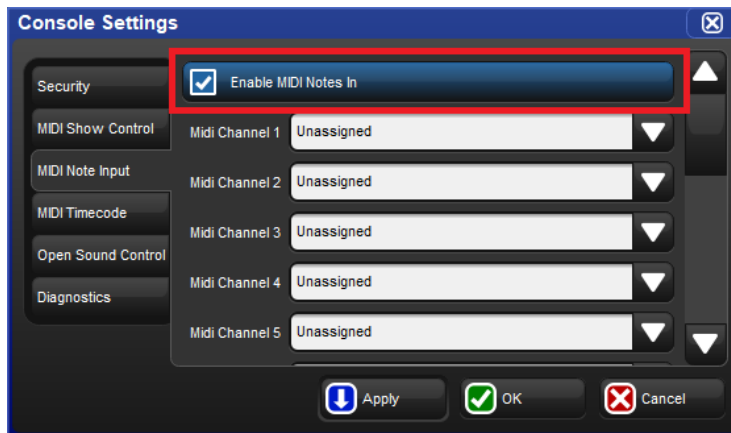

6. Select the MIDI Note Input tab.
7. Turn on the Enable Midi Notes In option and hit apply.

21.2.1 Assigning MIDI Note Input to Playback Bars

To assign MIDI Note information to playback bars:

1. Connect a MIDI device to a MIDI input on either the console or a USB MIDI input device connected to the console.
2. Setup → Network : open the Network window.
3. Select the console in the list.
4. Settings : open the Settings window.
5. Select the MIDI Note Input tab in the Console Settings window.
6. Ensure the Enable Midi Notes In option is turned on.
7. In the desired MIDI Channel assignment field, select a Playback Bar to associate with the MIDI Channel.

Any incoming MIDI Note information for the specified MIDI channel will use the following mappings for the selected playback bar and its associated functions:

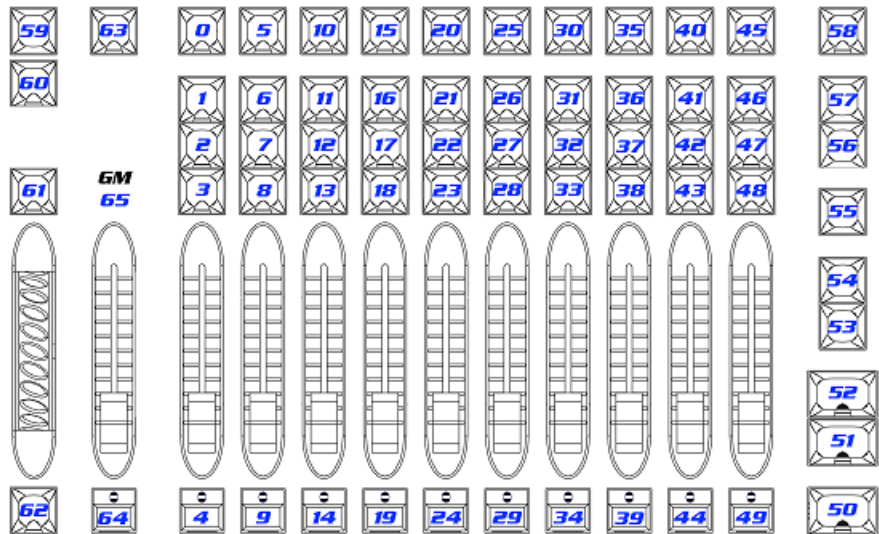

21.2.2 Assigning MIDI Note Input to Programming Keys

To assign MIDI Note information to programming keys:

1. Connect a MIDI device to a MIDI input on either the console or a USB MIDI input device connected to the console.
2. Setup → Network : open the Network window.
3. Select the console in the list.
4. Settings : open the Settings window
5. Select the MIDI Note Input tab of the Console Settings window.

6. Ensure the Enable Midi Notes In option is turned on.
7. In the desired MIDI Channel assignment field, select a Programming Keys to associate with the MIDI Channel.

Any incoming MIDI Note information for the specified MIDI channel will use the following mappings for the associated Programming Keys:

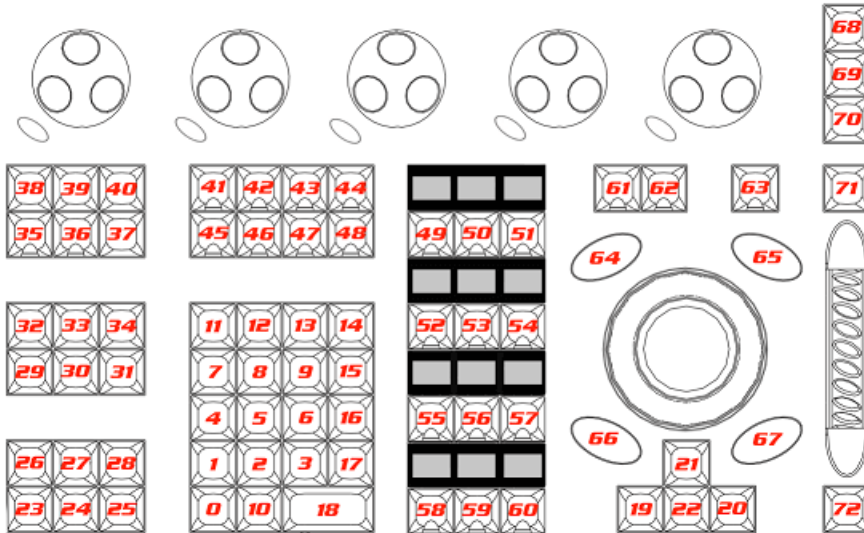

21.2.3 Assigning MIDI Notes Input to Encoders and Wheels

To assign MIDI Note information to the console's encoders and wheels follow the instructions below. Hog 4 PC requires that a Hog 4 series wing or ETC Max Nomad Key be attached to the PC to unlock this feature.

1. Connect a MIDI device to a MIDI input on either the console or a USB MIDI input device connected to the console.
2. Setup → Network : open the Network window.
3. Select the console in the list.
4. Settings : open the Settings window
5. Select the MIDI Note Input tab of the Console Settings window.
6. Ensure the Enable Midi Notes In option is turned on.
7. Select the Encoders option from one of the MIDI channel drop down menus to associate any incoming notes on that MIDI channel with the console's encoder wheels.

The following MIDI note mappings are used for encoders and wheels:

Function	Note	Function	Note
i-Wheel +	0	Encoder 3 +	12
i-Wheel (-)	1	Encoder 3 (-)	13
Trackball Pan +	2	Encoder 4 +	14
Trackball Pan (-)	3	Encoder 4 (-)	15
Trackball Tilt +	4	Encoder 5 +	16
Trackball Tilt (-)	5	Encoder 5 (-)	17
Trackball Ring +	6	Rate Wheel +	18
Trackball Ring -	7	Rate Wheel (-)	19
Encoder 1 +	8	Center Wheel +	20
Encoder 1 (-)	9	Center Wheel (-)	21
Encoder 2 +	10	Center Ring +	22
Encoder 2 (-)	11	Center Ring (-)	23

21.2.4 Assigning MIDI Note Input to Monitor Soft Keys

To assign MIDI Note information to monitor soft keys:

1. Connect a MIDI device to a MIDI input on either the console or a USB MIDI input device connected to the console.
2. Setup → Network : open the Network window.
3. Select the console in the list.
4. Settings : open the Settings window
5. Select the MIDI Note Input tab of the Console Settings window.
6. Ensure the Enable Midi Notes In option is turned on.
7. In the desired MIDI Channel assignment field, select Soft Keys to associate with the MIDI Channel.

Any incoming MIDI Note information for the specified MIDI channel will use the following mappings for the associated Soft Keys:

Button	Note	Button	Note	Button	Note
Lower Right 1	0	Upper Right 1	12	Upper Left 1	24
Lower Right 2	1	Upper Right 2	13	Upper Left 2	25
Lower Right 3	2	Upper Right 3	14	Upper Left 3	26
Lower Right 4	3	Upper Right 4	15	Upper Left 4	27
Lower Right 5	4	Upper Right 5	16	Upper Left 5	28
Lower Right 6	5	Upper Right 6	17	Upper Left 6	29
Lower Right 7	6	Upper Right 7	18	Upper Left 7	30
Lower Right 8	7	Upper Right 8	19	Upper Left 8	31
Lower Right 9	8	Upper Right 9	20	Upper Left 9	32
Lower Right 10	9	Upper Right 10	21	Upper Left 10	33
Lower Right 11	10	Upper Right 11	22	Upper Left 11	34
Lower Right 12	11	Upper Right 12	23	Upper Left 12	35

21.2.5 Assigning MIDI Note Input to Comment Macros

To assign MIDI Note information to comment macros:

1. Setup → Network : open the Network window.
2. Select the console in the list.
3. Settings : open the Settings window.
4. Select the MIDI Note Input tab.
5. Ensure the Enable Midi Notes In option is turned on.
6. In the desired MIDI Channel assignment field, select Comment Macros to associate with the MIDI Channel.

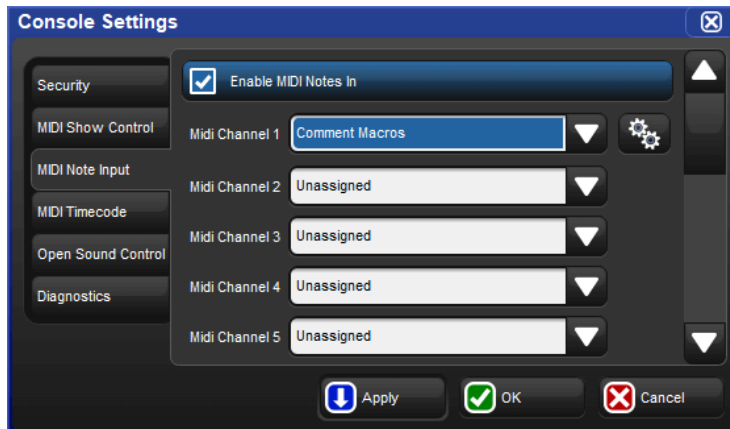

7. Click on the Configure



button to open the MIDI Notes window.

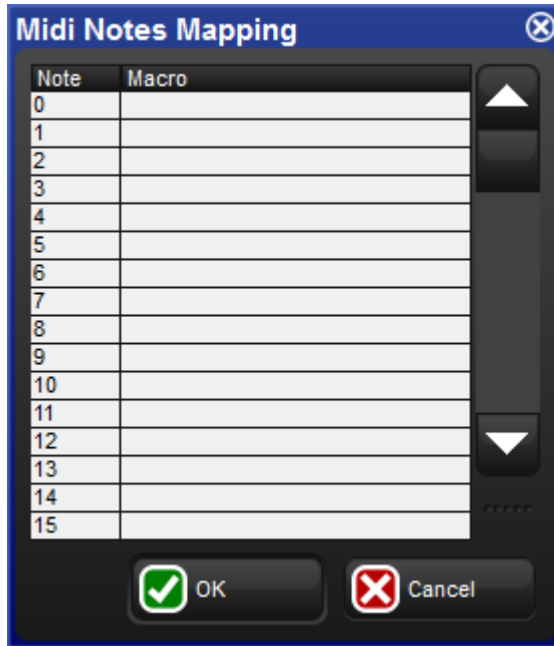

8. Assign a comment macro in the macro field to a specific MIDI Note value.

21.2.6 Using Midi Note Controller Messages to Control Faders

You can control the front panel faders of your console including the Grand Master fader by sending Midi controller event messages to the console. Hog 4 PC requires that a Hog 4 series wing or ETC Max Nomad Key be attached to the PC to unlock this feature.

Since the Hog 4 OS listens for Midi controller events on all midi channels a midi channel assignment for faders is not necessary however, the Enable Midi Notes In option located in the Midi Note Input tab of the console node settings window must be turned on.

The Hog 4 console's front panel faders are hard-coded to the following midi controller events (event values 0<127 = Hog 4 fader values 0<100):

Fader	Controller #
Grand Master	0
One	1
Two	2
Three	3
Four	4
Five	5
Six	6
Seven	7
Eight	8
Nine	9
Ten	10

21.3 MIDI Note Output

To send a midi note from the console:

1. Ensure the proper midi out device is selected in the MIDI tab of the control panel (HedgeHog 4 and Road Hog 4 consoles do not have a midi device built in. Therefore, an external generic midi class USB midi device must be connected)
2. Open the network window.
3. Select the console in the network window from which you wish to send midi notes.
4. Press the settings button at the top of the network window. This will open a settings window for the console.
5. Navigate to the "MIDI Show Control" tab in the console settings window and ensure that the MSC OUT option is enabled.
6. Open the midi note window by holding the Open key on the front panel and select the Midi Notes button from the open toolbar; this button will be on page 2 of the open toolbar for HedgeHog 4 and Road Hog 4 consoles).
7. Create a new entry in the midi note window by filling out the fields located at the top of the window and then press the Add button.

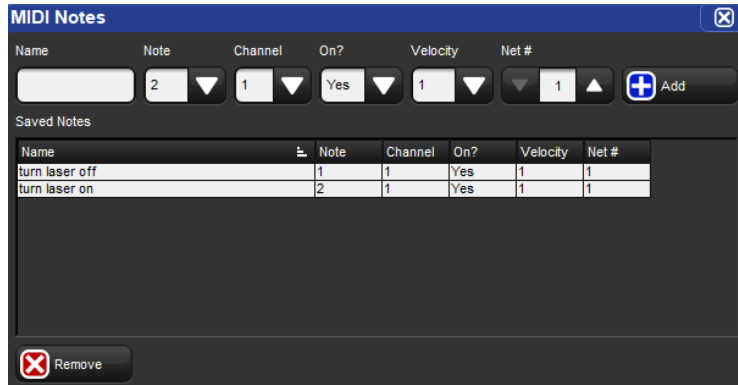

8. Select the comment macro field for any cue, scene, or page and press the Set key on the front panel.
9. Select the midi note entry you created in Step 4 from the drop down menu and press Enter. The comment macro will be prefixed with "MN" which indicates its a midi note message followed by the name of the message.

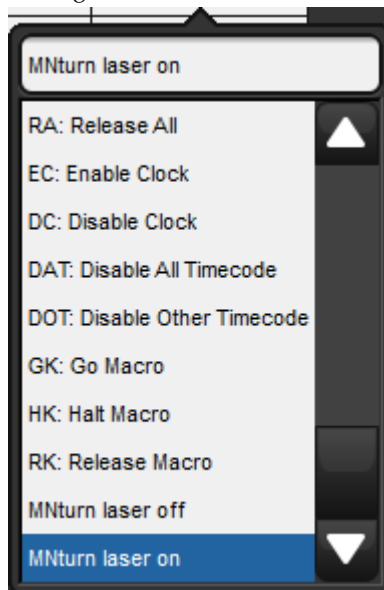

10. When the cue/scene/page is executed the referenced midi note message will be sent.

21.4 MIDI timecode

Midi Timecode brought into a console is automatically distributed over the network and can be used by any other console.

21.4.1 Connecting Midi Timecode Input

To connect a Midi timecode source to the console:

1. Connect the Midi source to the console's MIDI In port on the rear panel. . (If you are connecting an external USB device to the console for Midi Timecode input then connect the Midi source to the Midi Input port on the USB device. (Please note that only generic "USB MIDI Class" devices are supported by the consoles. USB midi devices that require proprietary drivers may work with Hog 4 PC as long as the specific driver is installed on the Windows machine but these types of USB devices that require specific drivers will not work with Hog 4 OS consoles.)
2. Setup → Control Panel : Navigate to the midi tab of the control panel. If you are using the console's built in midi input port to bring Midi Timecode into the console then make sure USB LTC Midi 1 is listed and selected as the midi input device. If you are using an external Generic Midi Class USB device the make sure you select that device from the input drop down menu.
3. Setup → Network : open the Network window.
4. Select the console in the list.
5. Settings : open the Settings window.
6. In the Timecode pane, select MIDI as the active port.

21.4.2 Viewing Incoming MIDI Timecode

You can view the timecode generated by any source in a Timecode Toolbar:

1. Setup → Network : open the Network window.
2. Select a network node, such as a console or dmx processor.
3. Press the settings button at the top of the network window.
4. For dmx processors: select the Timecode Widgets tab of the settings window, press the blue plus button to map a connected LTC widget to once of the timecode indexes, and then select the view toolbar button for that index entry.

For consoles: select the Midi Timecode tab of the settings window and enable the "View Timecode Toolbar" button.

If you have a cuelist with a timecode source selected, you can also open the Timecode Toolbar with the View Timecode button in the Cuelist window.

The Timecode Toolbar displays the incoming timecode type, format, value, and frame regeneration. Frame Regeneration occurs when the console does not receive a clean timecode signal and must make up for the missing frames itself in order to prevent missed cues. You can set how many frames of timecode are generated by the console before timecode is lost in the timecode settings window by clicking on the word TIMECODE in the timecode toolbar.

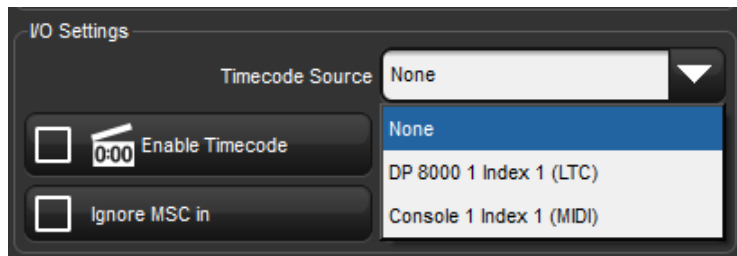

Figure 21.2. The Timecode Toolbar

21.4.3 Triggering Cues from MIDI Timecode

Each cuelist can be assigned to listen to different timecode sources from different consoles. To select Midi timecode as the source:

1. Open → Choose : open the Cuelist window.
2. Options → Cuelist : go to the Cuelist pane of the Playback Options window.
3. Select Midi timecode source from the drop down list:



4. Ensure that the Enable Timecode button is selected.



Tip

There is an Enable Timecode button in the Cuelist window, so you can easily enable and disable timecode during programming and playback without having to open the Playback Options window each time.

To trigger a cue from timecode:

1. Open → Choose : open the Cuelist window.
2. Select the Wait cell for the cue, and press Set.
3. From the toolbar, select Timecode.

4. Enter a timecode value in hours, minutes, seconds and frames, in the form **hh/mm/ss.ff**, then press Enter.

As well as entering timecode values manually, you can use Hog 4 OS's learn timing function to quickly associate timecode values with cues; see *Learn Timing (p.250)*.

By default, cuelists will follow the incoming timecode, even if the timecode skips forwards or backwards; generally, this is a useful behaviour as, for example, you might 'rewind' the timecode during rehearsals to repeat a part of the show, and the cuelist will automatically go to the correct cue. Sometimes you may want to prevent a cuelist going backwards if the timecode goes backwards. You can do this using Trigger Forwards Only:

1. Open + Choose → Options → Cuelist
2. Select Trigger Forwards Only.

21.4.4 Editing Timecode Values

To change the timecode value used to trigger a cue:

1. Open → Choose : open the Cuelist window.
2. Select the Wait cell for the cue, and press Set.
3. From the toolbar, select Timecode.
4. Enter a timecode value in hours, minutes, seconds and frames, in the form **hh/mm/ss.ff**, then press Enter.

You may need to change the timecode value for one cue, and then change the timecode values for subsequent cues by the same amount, to keep the same relative timings. For example, you might have a series of cues where each one is triggered by timecode one second after the previous one. If the timecode value triggering the first cue needs to be increased by 12 frames, you may want the values for all the subsequent cues to also be increased by 12 frames to maintain the 1 second separation. Hog 4 OS allows you to do this easily:

1. Open → Choose : open the Cuelist window.
2. Click and drag to select the Wait cells for the range of cues you want to edit.
3. Press Set.
4. Edit the timecode value of the first cell then press Enter. All the selected timecode values will be adjusted by the same amount of time added or subtracted from the first value.

21.4.5 Simulating MIDI Timecode

You can temporarily simulate midi timecode on the console using the Timecode Toolbar.

To simulate Midi timecode:

1. Press the simulate button on the Timecode Toolbar. Simulate is now enabled and all external timecode input for that source will be ignored.
2. Press the play button next to the simulate button to simulate timecode from the current clock value as displayed for that timecode toolbar.



TIP

Using the jump toolbar you can jump the simulated timecode value to six different jump points. To change the jump points click on the word "TIME-CODE" on the far left hand side of the timecode toolbar. A drop down menu will appear with a set of fields allowing you to change the simulated jump points.

Section 22: Open Sound Control

22.1 Introduction to OSC

Open Sound Control (OSC) is a modern network based communication protocol that can be used to send a variety of control messages between OSC enabled devices. OSC input is supported on every console in the Hog 4 family including Hog 4 PC. When configured properly OSC will enable you to use OSC enabled controllers such as a synthesizers, electronic music instruments, production audio software, and mobile phone apps such as Touch OSC to control the basic functions of the Hog 4 OS.

22.2 Configuring OSC Input

To bring OSC messages into the console:

1. Connect your OSC controller to a physical network port that is attached to the same local area network as the console's HogNet port.
2. Setup → Network : opens the network window
3. Right click on the console number and select Settings : opens the Settings window
4. In the Open Sound Control pane, enable OSC In and assign the input port to match the output port of your OSC output device. For your convenience the console's IP address is also listed to the right of the port number to assist in configuring the output of your other OSC devices.

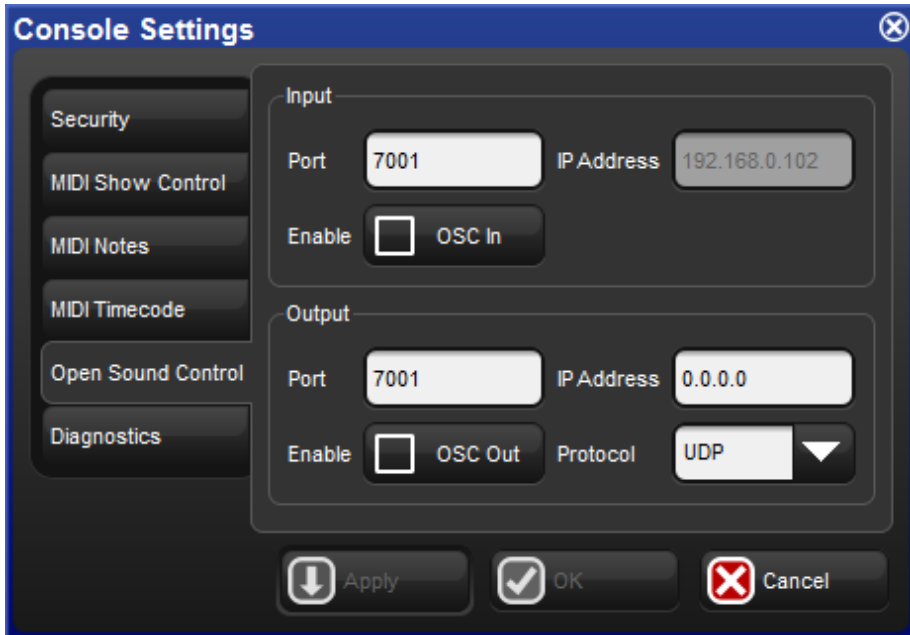

Figure 22.1. The OSC pane of the Console Settings window

22.3 Configuring OSC Output

To send OSC messages from the Console:

1. Connect your OSC controller to a physical network port that is attached to the same local area network as the console's HogNet port.
2. Setup → Network : opens the network window
3. Right click on the console number and select Settings : opens the Settings window
4. In the Open Sound Control pane, enable OSC Out and assign the output port to match the input port of your OSC output device. You must specify the IP address you wish to output to as well as which protocol you wish to use for OSC output.

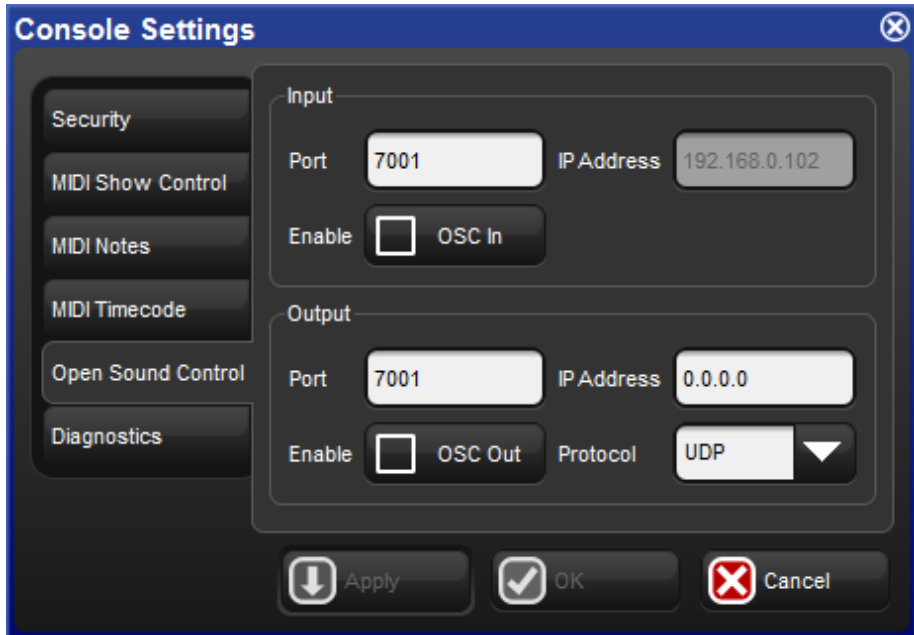

Figure 22.2. The OSC pane of the Console Settings window

22.4 OSC Mappings

22.4.1 OSC Playback Mappings

Hog 4 OS uses the following OSC paths and commands for sending and receiving **playback** messages:

Hog 4 OS	OSC Command Path	Data
Go a Cuelist	/ hog / playback / go / 0	cuelist #
Go a specific cue in a list (goto)	/ hog / playback / go / 0	cuelist #.cue #
Halt a Cuelist	/ hog / playback / halt / 0	cuelist #
Resume a halted cuelist	/ hog / playback / re- sume / 0	cuelist #
Release a Cuelist	/ hog / playback / re- lease / 0	cuelist #
Go a Scene	/ hog / playback / go / 1	scene #
Halt a Scene	/ hog / playback / halt / 1	scene #
Release a Scene	/ hog / playback / re- lease / 1	scene #
Go a Macro	/ hog / playback / go / 2	macro #
Halt a Macro	/ hog / playback / halt / 2	macro #
Release a Marco	/ hog / playback / re- lease / 2	macro #

22.4.2 OSC Midi Note Mappings

Hog 4 OS uses the following OSC paths and commands for receiving **Midi Note** input:

For example, the Hog 4 OS recognizes **/ hog / midi / on / 1 / 10** as a "note on" command for note 10 on channel 1

Hog 4 OS	OSC Command Path	Data
Midi Note On	/ hog / midi / on / channel # / note #	velocity (if velocity = 0, then message is treated as note off)
Midi Note Off	/ hog / midi / off / channel # / note #	velocity

22.4.3 OSC Hardware Mappings

Hog 4 OS uses the following OSC paths and commands for receiving **hardware** messages (faders and encoders not supported on Hog 4 PC unless a Hog 4 Series wing is attached):

For keys not listed in the table below the OSC path is hog/hardware/button name as listed on the front panel.

For paths that contain "master #" use the master number for the front panel hardware you are trying to control. Master numbers 1 thru 90 are supported.

For example, to press the go button on the console's front panel for master 6 the OSC path is **hog / playback / go / 6**

Hog 4 OS	OSC Command Path	Data
Choose Keys	/ hog / hardware / choose / master #	0 = button up, 1 = button down
Go Keys	/ hog / hardware / go / master #	0 = button up, 1 = button down
Pause Keys	/ hog / hardware / pause / master #	0 = button up, 1 = button down
Back Keys	/ hog / hardware / goback / master #	0 = button up, 1 = button down
Flash Keys	/ hog / hardware / flash / master #	0 = button up, 1 = button down
Faders	/ hog / hardware / fader / master #	0 < 255 discreet fader value
Grand Master	/ hog / hardware / fader / 0	0 < 255 discreet fader value
Encoders	/ hog / hardware / encoder-wheel / #	-20 < 20 variable value
Encoder Wheel Buttons	/ hog / hardware / ewheel-button / #	0 = button up, 1 = button down
Rate Wheel	/ hog / hardware / rate-wheel	-20 < 20 variable value
i-Wheel	/ hog / hardware / iwheel	-20 < 20 variable value
i-Wheel Up Button	/ hog / hardware / iwheelup	0 = button up, 1 = button down
iWheel Down Button	/ hog / hardware / iwheel-down	0 = button up, 1 = button down
Pig Key	/ hog / hardware / pig	0 = button up, 1 = button down
Trackball POS Mode	/ hog / hardware / posmode	0= toggle off, 1 = toggle on
Trackball Position Value	/ hog / hardware / trackball	X,Y values
Period Key	/ hog / hardware / period	0 = button up, 1 = button down
0 key	/ hog / hardware / zero	0 = button up, 1 = button down
1 key	/ hog / hardware / one	0 = button up, 1 = button down
2 key	/ hog / hardware / two	0 = button up, 1 = button down
3 key	/ hog / hardware / three	0 = button up, 1 = button down
4 key	/ hog / hardware / four	0 = button up, 1 = button down
5 key	/ hog / hardware / five	0 = button up, 1 = button down
6 key	/ hog / hardware / six	0 = button up, 1 = button down
7 key	/ hog / hardware / seven	0 = button up, 1 = button down
8 key	/ hog / hardware / eight	0 = button up, 1 = button down
9 key	/ hog / hardware / nine	0 = button up, 1 = button down
Arrow Up key	/ hog / hardware / up	0 = button up, 1 = button down
Arrow Down key	/ hog / hardware / down	0 = button up, 1 = button down

Hog 4 OS	OSC Command Path	Data
Arrow Left key	/ hog / hardware / left	0 = button up, 1 = button down
Arrow Right key	/ hog / hardware / right	0 = button up, 1 = button down
@ key	/ hog / hardware / at	0 = button up, 1 = button down
- key	/ hog / hardware / minus	0 = button up, 1 = button down
+ key	/ hog / hardware / plus	0 = button up, 1 = button down
/ key	/ hog / hardware / slash	0 = button up, 1 = button down
backspace key	/ hog / hardware / back-space	0 = button up, 1 = button down
H keys (function keys)	/ hog / hardware / h#	0 = button up, 1 = button down
Main Play key	/ hog / hardware / maingo	0 = button up, 1 = button down
Main Pause key	/ hog / hardware / mainhalt	0 = button up, 1 = button down
Main Back key	/ hog / hardware / main-back	0 = button up, 1 = button down
Center Choose key	/ hog / hardware / main-choose	0 = button up, 1 = button down
Skip Forward	/ hog / hardware / skipfwd	0 = button up, 1 = button down
Skip Back	/ hog / hardware / skipback	0 = button up, 1 = button down

22.4.4 OSC Status Mappings

Hog 4 OS outputs the following **status** messages to OSC controllers:

Hog 4 OS	OSC Command Path	Example
Front Panel LED Status	/ hog / status / led / button name	hog / status / led / clear
The Command Line	/ hog / status / command-line	hog / status / commandline
Encoder Wheel Labels	/ hog / status / encoder-wheel# / label	hog / status / encoderwheel3 / label
Encoder Wheel Values	/ hog / status / encoder-wheel# / value	hog / status / encoderwheel3 / value
Function Key Labels (Line 1)	/ hog / status / h# / line1	/ hog / status / h1 / line1
Function Key Labels (Line 2)	/ hog / status / h# / line2	/ hog / status / h1 / line2
Most Recent Chat Message	/ hog / status / chatline1	/ hog / status / chatline1
Second Most Recent Chat Message	/ hog / status / chatline2	/ hog / status / chatline2
Third Most Recent Chat Message	/ hog / status / chatline3	/ hog / status / chatline3

22.5 OSC over WiFi

Sending and receiving OSC over WiFi is supported by Hog 4 OS through the use of 3rd party wireless routers, however, High End Systems does not recommend using OSC over WiFi for critical show tasks for several reasons:

- **Reliability**: Some mobile OSC software applications such as TouchOSC only support UDP (User Datagram Protocol) communications which do not include error-checking. This means that Hog 4 OS cannot verify that OSC messages sent by the console will be received by mobile clients and vice-versa.
- **Interference**: Wireless routers that operate in the 2.4 GHz radio spectrum are subject to large amounts of interference due to the popularity of the 2.4 GHz radio band for consumer-grade wireless devices. Other electronics such as microwaves are known to emit interference in the 2.4 GHz band. The spacing of the communication channels used within the 2.4 GHz spectrum is also narrow. Therefore, in cases where OSC over WiFi is to be used, High End Systems recommends only using wireless routers and mobile devices that support 5 GHz radio transmission using the 802.11 AC Wireless specification.
- **Multi-Cast Routing**: The HogNet network (in which the OSC messages are integrated) utilizes multi-cast network traffic for communication

between consoles and DPs which can present a challenge to the processors housed in low cost wireless routers.

High End Systems cannot guarantee the performance of UDP based wireless OSC messaging systems. All Wifi based OSC setups should be well-tested before being trusted for live show operation.

Section 23: Linear Timecode (LTC)

23.1 LTC Input into Console

Linear Timecode (LTC) is a form of SMPTE timecode encoded into an audio signal. The Hog 4 OS can listen to LTC by inputting the LTC signal directly into the back of the Hog 4 or Full Boar 4. The Road Hog 4 and HedgeHog 4 consoles do not have an LTC input built into the back of the console and therefore require that a USB LTC widget be attached.

To bring LTC into the system through the console:

1. Connect the LTC source (timecode generator) to the LTC IN port on the console's rear panel using a balanced 3-pin XLR connector (you can plug in up to eight external USB LTC widgets to the console for additional LTC inputs)
2. Setup → Network : opens the Network window.
3. In the network window right click the DP8000 that is associated with console's built in outputs; this is typically DP8000 #1 unless you have configured the console's internal DP8000 to run on a different net number.

NOTE: You must be running an internal DP8000 on the console to bring LTC input into the desk as LTC input is handled by the DP8000 process.

4. Select Settings from the right click menu : opens the Settings window.
5. In the Timecode Widgets pane, use the drop down menu to map the built-in LTC widget (or any external USB LTC widgets) to an index.



23.2 LTC Input into a DMX Processor 8000

Linear Timecode (LTC) is a form of SMPTE timecode encoded into an audio signal. The Hog 4 OS can listen to LTC by inputting the LTC signal to a USB LTC widget attached to a DP8000.

To bring LTC into the system using a DMX Processor 8000:

1. Connect an external USB LTC widget to one of the USB ports on the rear panel of the DMX Processor 8000 (up to 8 USB LTC widgets are supported on the DP8000; each LTC input is mapped to an "Index")
2. Connect the LTC source to the LTC widget using a balanced 3-pin XLR connector
3. Setup → Network : opens the Network window.
4. In the network window select the DP8000 that you connected the LTC Widget to
5. Settings : opens the Settings window.
6. In the Timecode Widgets pane, use the drop down menu to map the attached LTC widget to an index.



23.3 Viewing Incoming LTC

You can view the LTC being processed by any DP8000 in the system by opening the Timecode Toolbar associated with that DP8000:

1. Setup → Network : open the Network window.
2. Select the DP8000 in the list that you wish to view incoming LTC (for LTC inputs directly into a console this is going to be the DP8000 that is running internally on that console)
3. Settings : opens the Settings window
4. Click on the view timecode toolbar button associated with the LTC index you wish to view.

If you have a cuelist with a timecode source assigned in the options for that cuelist then you can open the Timecode Toolbar with the View Timecode button in the Cuelist window.

From left to right the Timecode Toolbar displays the logical name of the timecode source, the index number for that source, the timecode type, the timecode format, the timecode clock value, and the number of frames generated by the console / the number frames the console is configured to auto-generate when the incoming timecode source stutters or drops out.



Figure 23.1. The Timecode Toolbar

23.4 Triggering Cues from LTC

Cuelist can be assigned to listen to a single LTC source. To select an LTC timecode source for a cuelist:

1. Open → Choose : opens the Cuelist window.
2. Options → Cuelist : go to the Cuelist pane of the Playback Options window.
3. Select LTC timecode source from the drop down list. Each source will have a node name and an index.
4. Once you have chosen the timecode source ensure that the Enable Timecode button is selected.



Tip

There is an Enable Timecode button in the Cuelist window, so you can easily enable and disable timecode during programming and playback without having to open the Playback Options window each time.

To trigger a cue from timecode:

1. Open → Choose : open the Cuelist window.
2. Select the Wait cell for the cue, and press Set.
3. From the toolbar, select Timecode.
4. Enter a timecode value in hours, minutes, seconds and frames, in the form **hh/mm/ss.ff**, then press Enter.

As well as entering timecode values manually, you can use Hog 4 OS's learn timing function to quickly associate timecode values with cues; see *Learn Timing (p.250)*.

By default, cuelists will follow the incoming timecode, even if the timecode skips forwards or backwards; generally, this is a useful behaviour as, for example, you might 'rewind' the timecode during rehearsals to repeat a part of the show, and the cuelist will automatically go to the correct cue. Sometimes you may want to prevent a cuelist going backwards if the timecode goes backwards. You can do this using Trigger Forwards Only:

1. Open + Choose → Options → Cuelist
2. Select Trigger Forwards Only.

23.5 Editing Timecode Values for a Cue

To change the timecode value used to trigger a cue:

1. Open → Choose : open the Cuelist window.
2. Select the Wait cell for the cue, and press Set.
3. From the toolbar, select Timecode.
4. Enter a timecode value in hours, minutes, seconds and frames, in the form **hh/mm/ss.ff**, then press Enter.

You may need to change the timecode value for one cue, and then change the timecode values for subsequent cues by the same amount, to keep the same relative timings. For example, you might have a series of cues where each one is triggered by timecode one second after the previous one. If the timecode value triggering the first cue needs to be increased by 12 frames, you may want the values for all the subsequent cues to also be increased by 12 frames to maintain the 1 second separation. Hog 4 OS allows you to do this easily:

1. Open → Choose : open the Cuelist window.
2. Click and drag to select the Wait cells for the range of cues you want to edit.
3. Press Set.
4. Edit the timecode value of the first cell then press Enter. All the selected timecode values will be adjusted by the same amount of time added or subtracted from the first value.

23.6 Simulating LTC

You can temporarily simulate timecode, perhaps because the actual LTC source is not available during programming. Timecode simulation is controlled from the Timecode Toolbar.

To simulate timecode:

1. Press the simulate button on the Timecode Toolbar. Simulate is now enabled and all external timecode input for that LTC source will be ignored.
2. Press the GO button located to the right of the simulate button to simulate timecode.



TIP

Using the jump toolbar you can jump the simulated timecode to six different jump points by clicking on the jump button and then clicking on one of the six jump buttons. To change the jump button values click on the word "TIMECODE" on the far left hand side of the timecode toolbar. A drop down menu will appear with a set of fields allowing you to change the jump points.

Section 24: Macros

24.1 Intro to Macros

There are two types of macros you can use to automate tasks on the console. *Comment Macros* are placed in the macro field of cuelist and other objects to trigger activity on the console. *Keystroke Macros* allow a sequence of screen and button presses to be recorded for later playback.

24.2 Comment Macros

You can use comment macros to automate tasks on the console such as:

- Going, Halting, Asserting, Releasing and Fading Masters.
- Going, Halting, Asserting and Releasing Cuelists.
- Going, Halting, Asserting and Releasing Scenes.

Comment macros can be configured to run at these times:

- When a show is launched; see *Startup Comment Macros (p.94)*.
- When a page is loaded; see *Restoring Activity When Changing Pages (p.338)*.
- When a cue or scene plays; see *Triggering Automatic Tasks When a Cue Runs (p.326)*.

Comment Macros are text commands that you type or place into a macro cell; the syntax used is the same in each case:

Controlling Masters			
<i>Comment</i>	<i>Macro Syntax</i>	<i>Example</i>	<i>Notes</i>
Go Master	GM[<i>master</i>]/[<i>cue</i>]	GM1/3	Use ``*`` for the current chosen master. If you omit the cue number, the next cue will Go.
Go Master	GM[<i>range</i>]	GM2>7	Go next cue on a range of masters.
Halt Master	HM[<i>master or range</i>]	HM1,3:HM2>7	
Assert Master	AM[<i>master or range</i>]	AM1:AM2>7	
Release Master	RM[<i>master or range</i>]	RM1:RM2>7	
Release All	RA	RA	Equivalent to Pig + Release.
Release Others	RO	RO	Releases all masters except the one with the macro.
Fade Master	FM[<i>master</i>]/[<i>level</i>][<i>timing</i>]	FM2/50t2	Fades master 2 to 50% in 2 seconds. To fade in 0s omit the timing portion of the macro.
Fade Grand Master	FGM[<i>level</i>][<i>timing</i>]	FGM10t3	Fades the grand master to 10% in 3 seconds. To fade the grand master in 0s omit the timing portion of the macro.
Choose Master	CM[<i>master</i>]	CM1	

Controlling Cuelists			
<i>Comment</i>	<i>Macro Syntax</i>	<i>Example</i>	<i>Notes</i>
Go Cuelist	GL[<i>list</i>]/[<i>cue</i>]	GL1.5, GL2/5	If you omit the cue number, the next cue will Go.
Halt Cuelist	HL[<i>list</i>]	HL1,6	
Assert Cuelist	AL[<i>list</i>]	AL10	
Release Cuelist	RL[<i>list</i>]	RL4,7,9	

Controlling Batches			
<i>Comment</i>	<i>Macro Syntax</i>	<i>Example</i>	<i>Notes</i>
Go Batch	GB[<i>batch</i>]	GB12	
Halt Batch	HB[<i>batch</i>]	HB1	
Assert Batch	AB[<i>batch</i>]	AB10	
Release Batch	RB[<i>batch</i>]	RB4	

Controlling Scenes			
<i>Comment</i>	<i>Macro Syntax</i>	<i>Example</i>	<i>Notes</i>
Go Scene	GS[scene]	GS12	
Halt Scene	HS[scene]	HS4	
Assert Scene	AS[scene]	AS1	
Release Scene	RS[scene]	RS6, 20	

Controlling Pages, Playback Bars, and Views			
<i>Comment</i>	<i>Macro Syntax</i>	<i>Example</i>	<i>Notes</i>
Change Page	CP[page]	CP3	
Next Page	CP+	CP+	Goes to the next page in the Page Directory, skipping the template page and blank pages.
Previous Page	CP-	CP-	Goes to the previous page in the Page Directory, skipping the template page and blank pages.
Recall View	RV[view]	RV2	
Dock Playback Bar	DPB#	DPB2	Docks the specified playback bar to its docking assignment.

Controlling Timecode			
<i>Comment</i>	<i>Macro Syntax</i>	<i>Example</i>	<i>Notes</i>
Enable Timecode	ET[cuelist]	ET2	Enables timecode for the selected cue list.
Disable Timecode	DT[cuelist]	DT2	
Open Timecode Toolbar	OT[node type][node number]	OTb1	When DP8000 is specified as the node type then an index number is also required; example: OTd1/1

Enabling / Disabling Clock Triggers			
<i>Comment</i>	<i>Macro Syntax</i>	<i>Example</i>	<i>Notes</i>
Enable Clock	EC[cuelist]	EC2	Enables clock triggers for Cuelist 2
Disable Clock	DC[cuelist]	DC2	Disables clock triggers for Cuelist 2

Sending MIDI strings	
<i>Comment Macro Syntax</i>	<i>Example</i>
MIDI String	MS[node type][node number]/[MIDI message] MSh1/90 47 3F
<p>Midi strings can be used to send System Exclusive Midi Messages or Midi Note Messages but must be written using hex values (see <i>Decimal to Hex Conversion Chart (p.480)</i>). Listed below is a break down of how a midi string comment macro would be formatted for sending a midi note: MSh1 - indicates midi string will be sent from Hog Console with net number 1 (forward slash) 9 - indicates note on (8 indicates note off) 0 - midi channel number (0 in hex = 0 in decimal) (SPACE) 47 - midi note number (47 in hex = 71 in decimal) (SPACE) 3F - velocity (3F in hex = 63 in decimal) A simpler method for sending midi notes via comment macros is explained in the "sending midi notes" section below.</p>	

Sending MIDI Notes	
<i>Comment Macro Syntax</i>	<i>Example</i>
MIDI Note	MN[reference to entry] MNGoLaser
<p>In order to utilize midi note comment macros the user must first create entries in the "Midi Notes" window which can be opened by holding the Open key on the front panel and selecting the "Midi Notes" button on the open toolbar. Once a midi note message entry has been created in the Midi Note Window it will appear in the comment macro drop down menu for cues, scenes, and pages. If the details of a midi note entry are changed in the midi note window then any cues and scenes, or pages referencing that entry will also be updated.</p>	

Controlling Network Devices	
<i>Comment Macro Syntax</i>	<i>Example Notes</i>
Reset Node [node type][net number] RNH3	Resets the selected network device, such as a DMX Processor. For the device type, use the following letter codes: H for Wholehog, D for DMX Processor .

Controlling Keystroke Macros			
<i>Macro</i>	<i>Syntax</i>	<i>Example</i>	<i>Notes</i>
GK	GK [macro number]	GK2	Runs Macro 2
HK	HK [macro number]	HK2	Pauses Macro 2
RK	RK [macro number]	RK2	Stops Macro 2

**Tip**

You can display and select from a list of available macro commands on the console by selecting the Macro cell and pressing the Set key.

24.2.1 Entering Comment Macro Commands

To enter a comment macro command into a macro cell:

1. Select the macro cell, and press Set.
2. Select a command from the drop down menu.

3. Enter the specific information for the macro, such as the master number.
4. Press Enter to finish or select another macro and repeat. If you add a further macro command, the ':' will be entered automatically.

Alternatively:

1. Select the macro cell, and press Set.
2. Enter the macro command manually using the keyboard.
3. Press Enter to finish.

Note that if you enter an invalid command, then the cell will revert to being empty when you press Enter.

24.2.2 Additional Comment Macro Syntax

For some comment macro commands such as fading masters you can specify the execution timing of the macro by adding a "t" followed by a numerical value in seconds:

```
FM10/1t10
```

Also within a comment macro command, you can specify multiple targets separated with commas:

```
RS6,20
```

or a range with a right angle-bracket:

```
HM2>7
```

You can have multiple comment macros executed by one cue by separating them with colons:

```
HM1,3:HM2>7
```

You can also send commands to a specified network device, using **H** (Hog) to refer to a console, **D** to refer to a DMX Processor, and **IOP** to refer to an MIDI/Timecode Processor. For example:

```
GM1H2 : will Go master 1 on console number 2.
```

```
RND3 : will reset DMX Processor number 3.
```

24.3 Keystroke Macros

Keystroke Macros are a series of keystrokes, screen events, and encoder movements that are recorded into an object similar to a cue list. When the Keystroke Macro is ex-

ecuted, the recorded key presses and actions are regenerated. Keystroke Macros can be executed manually or triggered by Comment Macros.

24.3.1 Recording Keystroke Macros

Key presses, screen events, and encoder movements can be recorded interactively and are always recorded into Macros in the Macro directory. To begin recording key presses:

1. Record, Macro: the Macro Directory opens.
2. (Macro 2): choose a location in the directory

Or, using the commend line, press:

- Record, Macro, 2, Enter

If you leave out the Macro location:

- Record, Macro, Enter

The Keystroke Macro will be recorded in the next available location. If the destination Macro already exists, a pop-up will offer options: Insert, Merge, Replace.

When the Keystroke Macro begins recording, the Macro key LED will flash red and



will display in the far right of the command line to signify that recording has commenced.

All subsequent button presses, screen events, and encoder movements will be recorded into the specified Keystroke Macro. The time interval between the previous and current button press will also be recorded. Only one macro can be recorded at a time; the console will not allow you to record another macro while one is being recorded.

To stop the recording of a Keystroke Macro:

- Pig + Macro key.

The Macro key LED will stop flashing and the



will disappear from the command line to signify that the macro has stopped recording.

To stop the recording of a Keystroke Macro:

- Pig + Macro key.

The Macro key LED will stop flashing and the



will disappear from the command line to signify that the macro has stopped recording.

24.3.2 Naming Keystroke Macros

You can give a Macro a name that will be displayed in the Macro Directory window:

1. Open + Macro : open the Macro Directory
2. Check that the Guard button is selected, so that you don't accidentally active a Macro when pressing its button in the directory.
3. Select the Macro.
4. Set, [Name], Enter: type in the name



Tip

To name a Macro immediately after recording it, press the Set key to open a Quickname window. Enter the Macro name and press OK to select.

24.3.3 Keystroke Macro Playback

Every time a Keystroke Macro is recorded, it will automatically recall the state of the windows at the time of the recording. This assures that when a macro is run that the windows are set up in the correct places for touch screen presses. At the time of macro playback, the current onscreen windows will be replaced with that of the macro.

If the macro does not contain any specific touch screen presses, you can delete the Recall View step from the macro list. See *Comment Macros (p.399)* for editing information.



Tip

While macros provide users with increased functionality, they can also cause severe problems if misused, even causing the console to lock up.

During macro playback, manual functions may become unavailable or interfere with the macro playback. For instance, if you enter information on the command line as the macro is doing the same, the resulting command line structure may become invalid.

Macros have no intelligence; avoid recoding sequences that access items that are likely to be moved or deleted. For example, consider the macro sequence where a cuelist is opened and some edit operations are then performed on this cuelist. The cuelist is then deleted from the cuelist directory, and the macro replayed. No cuelist window will open since the cuelist no longer exists, so all the subsequent edit operations will occur on whatever window was below it, possible altering the contents of unintended items.

When opening a window it will appear in the position in which it was last used. This means that unless the window is open when the macro is recorded, there is no guarantee that it will open in the right place with the macro is replayed. For example, consider recording a macro with a blank set of screens. The group window is opened and a couple of buttons are touched, then recording is stopped. Move the group window to the other touch screen and close it. When the macro is replayed, the group window will get opened on the other touch screen, but all the touch screen presses will still be on the original (blank) touch screen.

It is also possible to speed up a macro so that it runs faster than the console can keep up with. This problem tends to manifest itself as key presses being missed out when replaying the macro. Increasing the amount of time in the Wait column of the macro will solve this problem. The size of the wait required varies depending upon the number of things the desk is trying to do at once, and the complexity of the task initiated by the preceding key presses.

To stop the playback of a running macro:

1. Macro + Release
2. Alternatively, Pig + Macro.

Running a Keystroke Macro from the Macro Directory Window

You can run Keystroke Macros from the Macro Directory window:

Open + Macro

OR

- Macro, Macro

To run a Macro, make sure that the Guard button in the Macro Directory window is deselected. Then press a Macro button in the directory, and it will playback. During Macro playback, the Macro LED will illuminate green and



will appear to the right of the command line.

The Macro buttons in the directory are colored to show the Macro status:

- Red: the Macro is recording.

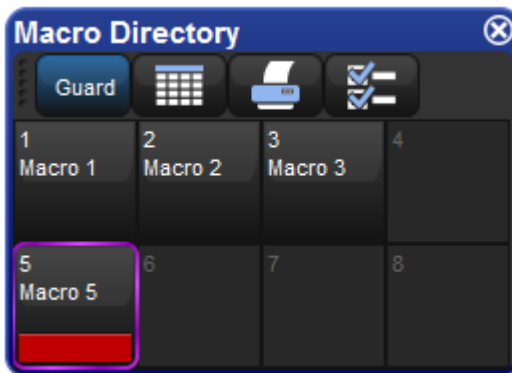

- Green: the Macro is running.

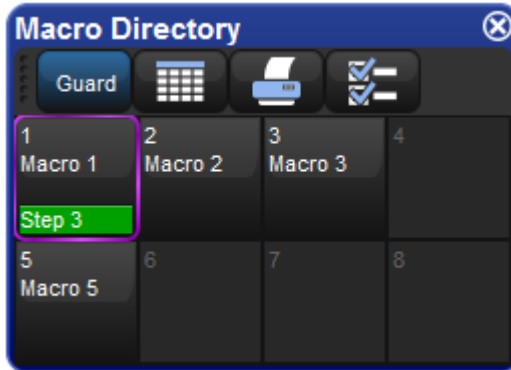

Running a Keystroke Macro from the Macro Window

1. Open + Macro: open the Macro Directory Window.
2. Check that the Guard button is depressed.
3. Open + (Macro 4): open the required Macro.
4. Press the Play Controls button in the Macro window. The on-screen playback controls will appear:

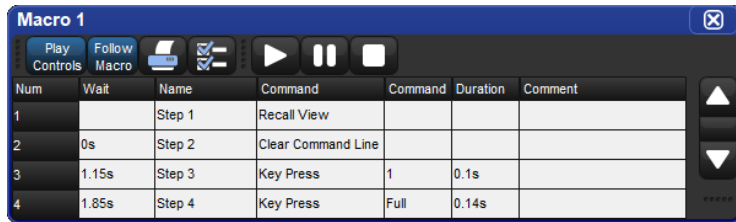

The controls are, from left to right, the Go, Pause, and Stop buttons.

During Macro playback, the Macro LED will illuminate green and



will appear to the right of the command line. When a Macro is paused, the Macro key LED will flash green.

Running Keystroke Macros from the Command Line

To run a Keystroke Macro from the command line:

Macro 1, Enter: sends a start command to Macro 1.

During Macro playback, the Macro LED will illuminate green and



will appear to the right of the command line.



Tip

Keystroke Macros can also be triggered within cuelists or scenes by using a Comment Macro. See *Comment Macros* (p.399) for more information.

24.3.4 Editing Keystroke Macros

You can edit the contents of a Macro in an editor window. For example, to open Macro 1 for editing:

1. Open + Macro: opens the Macro Directory.
2. Open + (Macro 1): opens the Macro editor for Macro 1.
3. Alternatively, using the command line: Open Macro 1

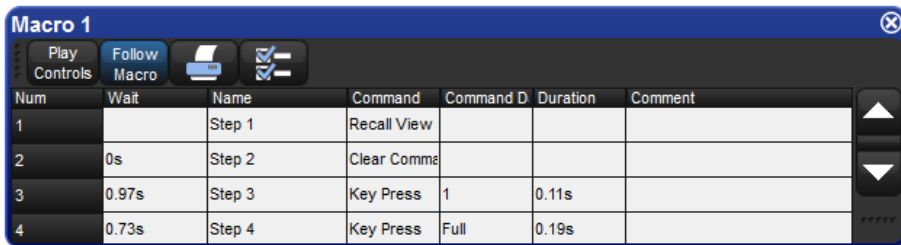

Figure 24.1. The Macro Window

The Keystroke Macro window has six columns that define each step of the macro.

- **Wait:** The Wait time is the time between the triggering of the previous step and the next step to be triggered.
- **Name:** The name of the step.
- **Command:** Type of command used in this step.
- **Command Data:** The data that is applied to the selected command. The type of command selected will determine the type of available command data.
- **Duration:** The amount of time for the command data to be applied. This information is useful for encoder movements and flash key presses.
- **Comment:** A notes field.

Each of the above fields can be edited by selecting the appropriate cell and pressing Set. Command and Command Data fields will display available selections. See *Figure 24.2, "Command Data Selection"*

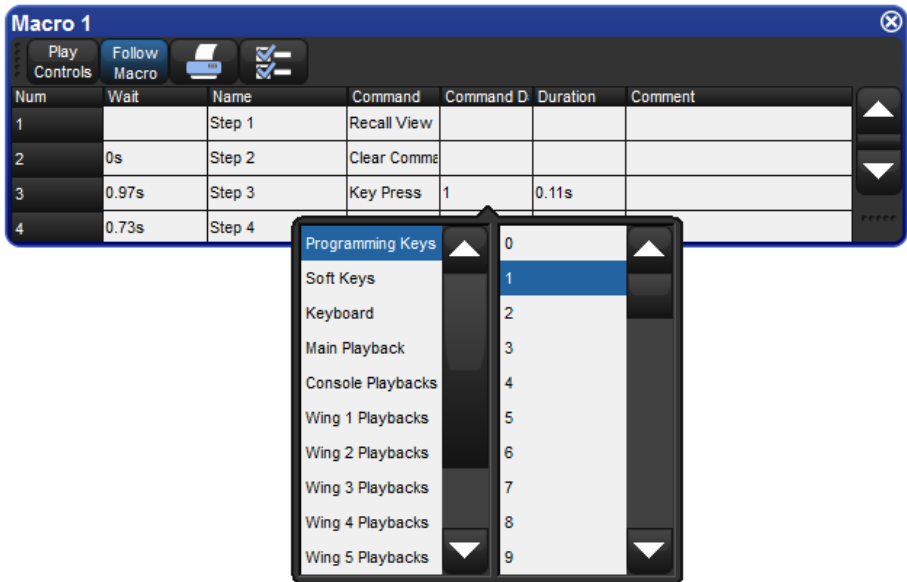

Figure 24.2. Command Data Selection

Deleting Keystroke Macro Steps

To delete a macro step:

1. Press and hold Delete whilst selecting the macro step to be deleted from the Macro window.
2. Release the Delete key. A dialog will appear asking you to confirm the delete.
3. Click OK.

24.3.5 Deleting Keystroke Macros

To delete a keystroke macro:

1. Macro 1 Delete: deletes Macro 1.
2. Click OK.

Or, from the macro directory:

1. Press and hold Delete whilst selecting the macro to be deleted from the Macro Directory window.

2. Click OK.

**Tip**

For advanced Macro control, you may wish to delete either of the first two default steps of a macro. The first step is a recall view and the second step clears the command line.

**Tip**

If you prefer not to be asked to confirm the delete action, select Don't Ask Me Again in the confirmation window. You can re-enable the confirmation by going to Macro → Preferences → Programming and selecting Confirm before deleting directory items.

24.3.6 Copying and Moving Keystroke Macros

To make a copy of a macro in a new location:

1. Open + Macro: open the Macro Directory.
2. Check that the Guard button is depressed so you do not accidentally apply macros when trying to select them.
3. Select the macro that you want to copy by pressing its button in the directory.
4. Press and hold the Copy key.
5. Press the button of the location in the directory you want to copy the macro to.

Or, using the command line:

- Macro 2 Copy Macro 3 Enter: copies the contents of Macro 2 to Macro 3.

Similarly, to move a macro to a new location:

- Macro 2 Move Macro 3 Enter: moves the contents of Macro 2 to Macro 3 leaving 2 empty. If the destination macro already exists, you will be asked to choose an option: Insert, Merge or Replace.

Insert, Add Steps, and Replace

When recording or copying a macro, if the destination location already has a macro recorded in it, you will be prompted with record options of Insert, Add Steps, or Replace. If you are moving a macro, only the Insert option is available.

- **Insert:** creates a new destination for the macro. The new macro will be assigned a free location just before the one chosen, using a point number if necessary.

- **Add Steps:** adds the macro steps from the source macro into the destination macro. All new information is appended to the end of the current macro steps.
- **Replace:** overwrites the macro information in that destination.



Tip

If you know that you are about to record, copy or move a macro to an existing destination, you can pre-select Insert, Merge or Replace from the Record Options Toolbar. This appears after you press the Record, Copy or Move keys.

Section 25: Direct Control of DMX Channels

25.1 The DMX Output Window

By default the DMX channel values output by the DP8000 are controlled by patched fixture data as programmed in the Hog show file. However, you may wish to override these values with manually entered DMX values or with Art-Net values streaming into the console from a remote third party Art-Net source such as another console. Both of these tasks can be accomplished in the DMX output window by following the instructions outlined in this chapter.

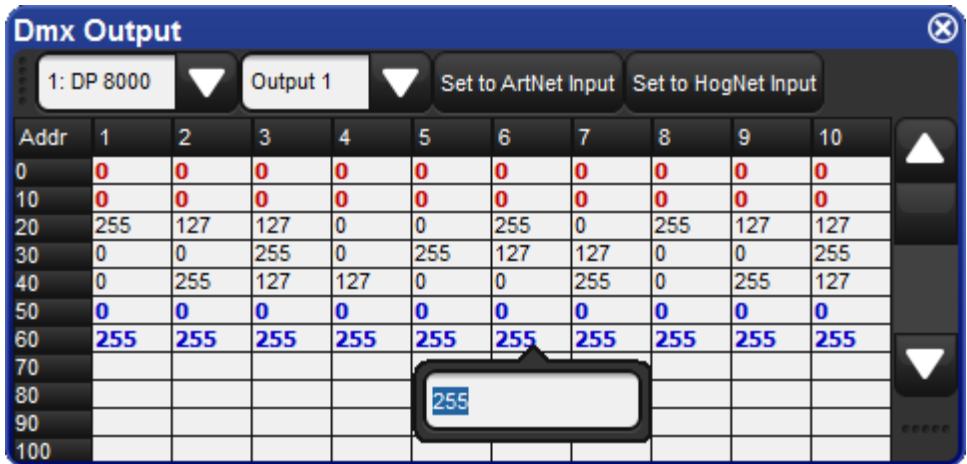

Figure 25.1. DMX Output Window

25.2 Manually specifying DMX Channel Values

To manually set a dmx channel or group of channels to a specific value:

1. Open the DMX Output window (press **SETUP** on the front panel and select the DMX button on the main toolbar)
2. Use the two drop down menus at the top of the DMX Output window to select the corresponding DP8000 and universe you wish the manipulate
3. Double click on the desired dmx channel cell in the spreadsheet (or highlight a group of dmx channel cells and press set)
4. Enter a valid dmx value (0 thru 255)

5. Press **Enter** to confirm (the value will now be displayed in blue)

25.3 Setting DMX Channels to External Art-Net Source

To set a dmx channel or group of dmx channels to values based on a remote Art-Net source:

1. Open the DMX Output window (press the SETUP key on the front panel and select the DMX button on the main toolbar)
2. Use the two drop down menus at the top of the DMX Output window to select the corresponding DP8000 and universe you wish the manipulate
3. Select the desired dmx channel cell in the spreadsheet (or highlight a group of dmx channel cells)
4. Press the "Set to Art-Net Input" button in the top (the value will now be displayed in red)
5. Open the network settings window for the corresponding DP8000 and ensure the corresponding Hog universe has its Art-Net input enabled and set to listen to the correct universe and sub-net (Fixture Net such as IP address and netmask must also be set appropriate as similar to when outputting art-net)



Caution

Do not configure the DP8000's Art-Net input and output settings for a given Hog universe to the same Art-Net subnet/universe.

25.4 Reverting DMX Channels to HogNet Control

To set a dmx channel or group of dmx channels back to values generated by Hog programming:

1. Select the desired dmx channel cell in the DMX output window's spreadsheet (or highlight a group of dmx channel cells)
2. Press the "Set to HogNet Input" button at the top of the window (the value will now be displayed in black)



Tip

All DMX channel value changes made in the dmx output window are stored with the show file and are persisted through log off/on as well as through show backups.

25.5 DMX Test

DMX Test allows users to temporarily set a dmx channel or group of dmx channels to a custom "value" as set in the scroll box at the top of the window when the coordinating cells are selected in the dmx output window:

1. Toggle on the Test button at the top of the dmx output window.
2. Select any dmx channel cell or group of dmx channel cells in the DMX output window spreadsheet.



Tip

The dmx test feature can be used to perform a traditional "dimmer check" by toggling on the Test button in the dmx output window, selecting a dmx channel cell in the spreadsheet, and using the cursor left and right keys to go through the dmx channels for that universe.

Section 26: Reporting

26.1 Creating, Running, and Managing Report Queries

The reporting tool of the Hog 4 OS enables users to quickly search for specific programming in the current show file by creating custom queries that search for specific show data. For example, you may want to identify which fixtures in the show are referencing position palette 12 in list 43. This data can quickly be found by running a report that queries for this data.

Reports are generated by running a report query which identifies which data you want the console to search for. This section will cover how to build, save, delete, and run report queries.

Follow these instructions of for **building** a new query:

1. Hold the OPEN key and press the “Report” button on the main toolbar to open a new reporting window.
2. Choose an option from the drop down menu for “Find programming that matches”:
 - When set to “all of the following” the console will only return data that matches all the query statements.
 - When set to “any of the following” the console will return data that matches any of the query statements.
3. At least one query statement is required in the query pane of the report window in order for the console to successfully run the report. To add or subtract query statements use the + and X buttons to the right of each query statement.
4. Once you are finished editing the query press the “Run” button.
5. The console will now run the query against the data in the show file and post the results of the query in the bottom half of the reporting window.

Follow these instruction to **save** a query:

1. Create a query in the query section of the report window.
2. Press the “Save Query” button.
3. Name the query in the save query dialogue box.
4. Press OK
5. The saved query will be listed in the query drop down menu at the top left of the report window. To recall a saved query simply select the query from the drop down menu.

Follow these instruction to **delete** a query:

1. Select a saved query from the "queries" drop down menu at the top left of the report window.
2. Press the "Delete Query" button



Tip

If you have a show file that contains reporting queries that you find particularly useful and that you wish to use in other show files then you can use the show merge utility to merge those report queries into other show files.

26.2 Organizing and Saving Report Results

By default the results of a report are aggregated and sorted by container (list/scene) and then further sorted by location, fixture, and function/value. However, you can custom sort, sub-sort, and sub-aggregate the results as you wish. To master sort and master aggregate the report results right click on any one of the column headers and select "sort". You can add other column headers into your master sort & aggregation by right clicking on a column header and selecting "sub-aggregate". For example, you can sort and aggregate the reporting results by container and then sub-aggregate by location so that each aggregate header encapsulates data reported for each cue in a list (e.g. List 1 - Cue 1).

Once a report is run and the data is organized to your liking you can export the results as a CSV file or a PDF document by pressing the corresponding button in the report window. A file browser will pop up allowing you to select a storage location for the saved report.

26.3 Using Report Results to Edit Programming

Clicking on any "location" cell in the report results will open that location inside of an editor. This allows users to view the data in the original editor, make changes, and update the look if necessary. Note: Function values cannot be edited directly in the report results sheet. You must first click on the location cell to open the data in an editor.

Section 27: Fixture Library

27.1 Introduction

A fixture library is a dedicated file installed into the libraries folder on the console that contains dmx mappings called "fixture types" which provide Hog 4 OS with a model for controlling a fixture's programmable parameters. When new fixtures are introduced to the market new fixture types must be created to enable control of those fixtures in the Hog 4 OS. To ensure that Hog programmers have control over the latest fixtures, a Full Fixture Library is automatically installed with each Hog 4 OS Software release. In addition, full library updates and individual fixture type libraries (based on user requests) are made available on the High End Systems website between console software releases. This section will cover how to download and install fixture libraries from the High End Systems website, how to submit a request to High End for fixture types not yet available online, and how to build your own fixture types using the Fixture Builder utility included in Hog 4 OS v3.9.0 and greater.

27.2 Download and Install Fixture Libraries

In most cases the best way to ensure you have the latest Hog 4 OS fixture library on your console is to ensure you are running the latest version of Hog 4 OS. However, sometimes High End will release full library updates as well as smaller single fixture libraries on the High End System website between software releases in order to ensure users have the most up-to-date information as possible. This section will cover how to install these full libraries onto a Hog 4 series console.

To install a fixture library onto console:

1. Download a supported fixture library from the web.
The latest full fixture library can be found at www.highend.com
2. Copy the downloaded fixture library to a USB flash drive.
3. Insert USB flash drive into the console.
4. Navigate to the Hog 4 OS start screen and click on the File Browser button.
5. Use the file browser window to drag and drop the fixture library file from the USB flash drive into the libraries directory on the console.
6. The fixture library is now installed on the console.

To schedule fixtures from the different fixture libraries installed on the console:

1. Open the Fixture Window.
2. Click on the Add Fixtures button.
3. Click on the Select Library button at the bottom of the fixture schedule window.
4. Choose the installed fixture library you want to schedule fixtures from and press okay.
5. Use the fixture schedule window to schedule fixtures from the fixture library you selected in step 4.

27.3 Request Fixture Types from High End Systems

In some cases the latest fixture libraries available may not contain the certain fixture types needed for a show. To submit a request to High End Systems to build the fixture type visit:

<http://request.highend.com/submit>

Please allow up to 14 days for libraries to be completed.

27.4 Build Fixture Types using Fixture Builder

In some cases a fixture type may not be available in the full fixture library and is needed in a shorter time frame then can be delivered through a fixture request on the High End Systems website. Or it may be the case that the fixture you need to control is custom made or a slight variation of a popular fixture already in the fixture library. In these cases the fixture builder included in Hog 4 OS is a great way to build, export, and share fixture types. This section will cover how to create, build, and export fixture types in Hog 4 OS using the fixture builder utility included in Hog 4 OS v3.9.0 and greater.

Libraries can be built from a blank canvas or can be copied from existing fixtures within the library (when using V4 libraries).

27.4.1 Creating a Fixture Type from Scratch

To create a fixture type from scratch:

1. Open the fixture window (open + fixture)
2. Click on the fixture builder button located at the top of the fixture window.
3. In the fixture builder window select the New Type... option from the current type drop down menu.

4. A new blank fixture type will be created and a set of tabs will populate along the left hand side of the window (Summary, Basic, Advanced, Functions).
5. Use the summary tab of the fixture builder to specify the fixture type's manufacturer, name, revision, author, and any notes you wish to add.
6. The fixture type's core dmx channel information, defaults, and options can now be created/edited using the basic, advanced, and function tabs. The best place to start is with the basic tab which is described in more detail in *Fixture Builder Basic View* (p.421).

27.4.2 Creating a Fixture Type from an Existing Type

In some cases you may need to create a fixture type that is loosely based on an established fixture type that is already available in the full fixture library. In this case it is recommended that you create a fixture type using data from an existing type using these steps:

1. Open the fixture window (open + fixture)
2. Click on the fixture builder button located at the top of the fixture window.
3. In the fixture builder window select the Copy Type... option from the current type drop down menu.
4. A window will pop up allowing you to choose an existing type from the Hog 4 fixture library currently being reference by the fixture scheduler.

Choose a fixture type from the list, then press the okay button.

5. Use the summary tab to make any desired adjustments to the fixture manufacturer, type name, revision, author, or notes. It is recommended to at least modify the fixture name to help differentiate it from the fixture it was copied from.
6. The fixture type can now be edited using the basic, advanced, and function tabs in the fixture builder. In most cases, altering and/or supplementing the copied fixture type data is most easy to accomplish using the advanced tab which is described in *Fixture Builder Advanced View* (p.424).

27.4.3 Fixture Builder Basic View

The basic tab of the fixture builder provides a simplified user interface for adding and modifying the basic dmx attributes of a fixture type. The first thing you will notice about the basic view are the large grey boxes labeled on the left with a number. These blocks represent the dmx channels of the fixture and are called dmx channel blocks. The diagram below shows the anatomy of a dmx channel block.

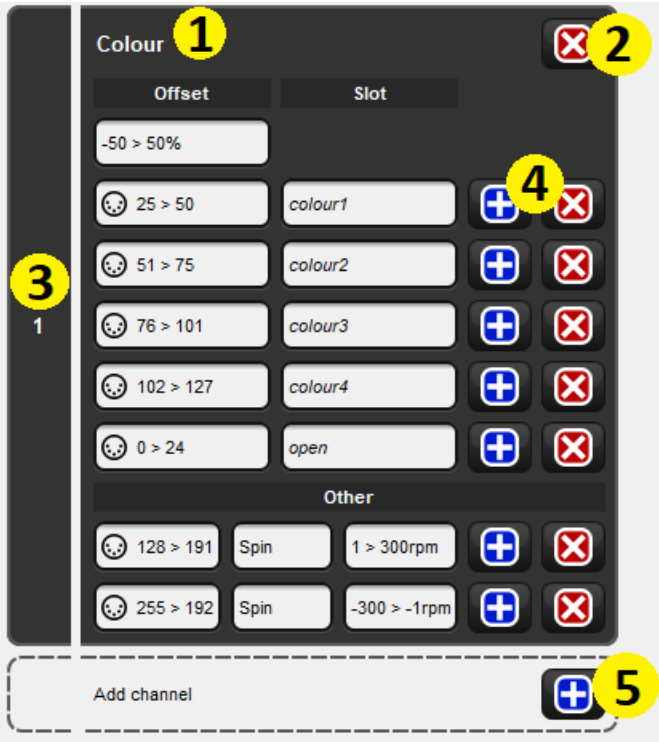

Figure 27.1. Basic View Diagram

- (1) Describes which function(s) are controlled by this channel.
- (2) Removes the function definition and leaves the dmx channel block as "unused".
- (3) Dmx channel number.
- (4) Adds/Removes individual entries for the dmx channel.
- (5) Adds a new dmx channel block to the fixture profile.

When adding new dmx channel blocks to a fixture, the console will display a menu of template items that can be used as a starting point for defining each dmx channel block. In some cases a template may describe multiple dmx channel blocks depending the fixture attribute. For example, 16-bit intensity is a 2 channel function that occupies two dmx channel blocks.

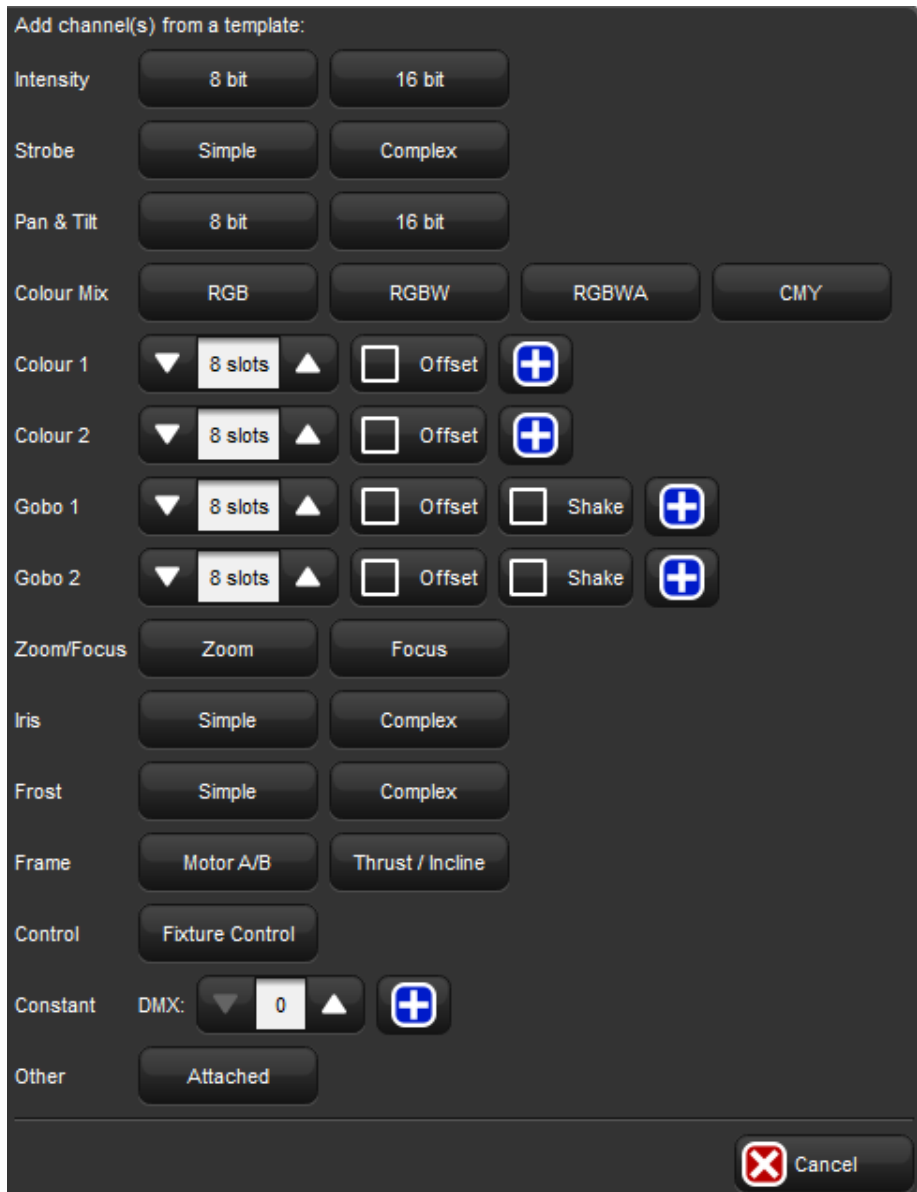

Figure 27.2. Template Menu

To **add** a new dmx channel block to the end of the fixture simply click on the blue plus symbol located in the "add channel" box.

To **remove** a dmx channel block click on the upper most red X button located in the dmx channel box.

To **move** a dmx channel block up or down, click and drag on the grey box which contains the dmx channel number for the dmx channel block.

To **add/remove** dmx entry use the blue plus and red x buttons within each dmx channel block.

27.4.4 Fixture Builder Advanced View

The advanced tab of the fixture builder provides a detailed and fully comprehensive view of a fixture type's dmx channel structure and allows for advanced editing of each dmx channel. Unlike the basic view, the advanced view give users access to every fixture function and feature supported by Hog 4 OS and allows for more complex relationships between fixture functions to be established through qualifiers (see *Fixture Builder Terminology* (p.427) for details on qualifiers).

The advanced view organizes the fixture type's dmx channel information into a collapsible tree structure. The black aggregation bars with white text represent the dmx channels. Nested within each channel are dmx entries (function/feature definitions) that make up the channel. To the right of the tree view is the edit pane which provides a contextual interface with menus and buttons that update based on the selected row in the tree view.

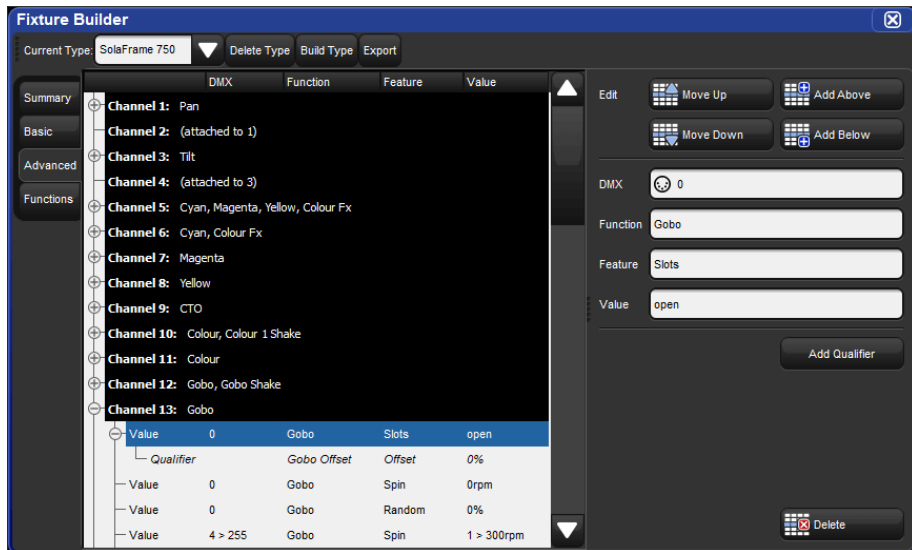

Figure 27.3. Advanced View Diagram

To **add** a new dmx channel, select a pre-existing dmx channel aggregation header (white text / black background) and then press the add above or add below button in the edit pane.

To **remove** a dmx channel, select the dmx channel's aggregation header (white text / black background) and then press the delete button at the bottom of the edit pane.

To **move** a dmx channel up or down, select the dmx channel's aggregation header (white text / black background) and then press the move up or move down button in edit pane.

To **add/remove/move** a dmx entry select the dmx entry row in the tree and then use the coordinating buttons in the edit pane.

27.4.5 Fixture Builder Functions Tab

The functions tab of the fixture builder contains a summary of all of the function/feature pairings used in the fixture type and allows for customization of the following:

Default Feature

Some functions only have one feature while others have several. When more than one feature is used for a function, use the default feature column in the functions tab to establish the fixture's default feature for that function.

Default Value

The "default value" column in the functions tab allows you to customize the default value for each function/feature pairing. The default value is used by Hog 4 OS to determine which real world value to revert to when the fixture is released. To edit a default value double-click on the cell containing the value, input the desired value, and press enter.

Virtual Intensity

In some cases a fixture's dmx profile may not have a dedicated intensity channel but rather several dmx channels controlling the light output of the fixture. The most common example is when a fixture has red, green, and blue LEDs that combine to make "white" light. Hog 4 OS simplifies the control of these fixture types through a concept known as virtual intensity.

To establish virtual intensity for a fixture type, click the virtual intensity check-box option for each function/feature you want to include in the fixture's virtual intensity operation. For example, if you are building a fixture type that has I-Red, I-Green, and I-Blue functions, then clicking the virtual intensity option for each one of these functions will result in the console creating a virtual intensity function that controls all of these parameters together. When a fixture with virtual intensity is built, the virtual intensity function will simply appear to the programmer as "intensity".



Caution

Intensity functions described with only a single dmx value are not eligible to be included in virtual intensity.

27.4.6 Building a Fixture Type

To build a fixture type in the fixture builder:

1. Select the fixture type you wish to build in the fixture builder's current type drop down menu.
2. Press the build type button at the top of the fixture builder window.
3. The fixture type is now copied into current show file and can be scheduled using the fixture scheduler. If you wish to export the fixture type to a library for use in another show then please refer to *Exporting Fixture Types to a Library* (p.426).

27.4.7 Exporting Fixture Types to a Library

Exporting a fixture type from the fixture builder into a new or existing library file is a simple process that allows you to stuff multiple custom fixture types into a single, portable, and sharable fixture library file.

To export a fixture type to a fixture library:

1. Open fixture builder and use the current type drop down menu to select the fixture type you wish to export.
2. Press the export button at the top of the fixture builder window.
3. When the file browser pops up you can do one of two things:
 - (1) Type in a new unique name to create a wholly new fixture library that will contain just the single type you are exporting. Then press enter.
 - (2) Select an existing fixture library already installed in the libraries directory on the console. This will add the fixture type to that library. Then press enter.
4. The fixture type will now be exported into the new (or pre-existing) fixture library. If you wish to archive the fixture library for use on other console proceed to the next step.
5. Insert a USB flash drive into one of the USB ports on the console.
6. Open the shows window (setup, shows) and select the file browser tab.
7. In the file browser, navigate to the library folder on the console's hard drive. Here you will find the fixture libraries installed on the console. Click and drag the desired fixture library from the library folder to the USB flash drive.
8. The console will prompt you to name the library archive. Give the archive a suitable name and press okay.
9. The fixture library is now archived on the USB flash drive and can be installed on any Hog 4 OS console running Hog 4 OS v3.9.0 or greater using the steps outlined in *Download and Install Fixture Libraries* (p.419).

27.4.8 Exporting Fixture Types to XML

To export fixture types from fixture builder to an XML file:

1. Press the Export XML button at the top of the fixture builder window.
2. Select the fixture type(s) you want to include in the XML file and press okay. Please note that fixture types copied from the fixture library are encrypted when exported and therefore cannot be edited using third party XML editor software.
3. Use the file browser to select a location for the XML file and press okay.
4. The resulting XML document can be viewed/edited on a Macintosh or Windows computer using a standard text editor or XML editor program. High End Systems recommends using an XML editor application that can validate the XML file using the Hog fixture library XML Schema Definition (XSD) which is referenced by all XML files exported by the Hog 4 OS fixture builder. Here are some cross-platform offline XML editing programs to consider:

- Oxygen [www.oxygenxml.com]
- Exchanger [www.exchangerxml.com]
- XMLmind [www.xmlmind.com]

27.4.9 Importing Fixture Types from XML

Fixture builder can import fixture types from XML files that are properly formatted and validated against the Hog fixture library XSD which is available online at [<http://schema.hogfour.com/fixture.xsd>].

To import an XML file containing fixture types into fixture builder:

1. Press the Import XML button at the top of the fixture builder window.
2. Select the XML file you wish to import using the file browser and then press OK.
3. All of the fixture types describe in the XML file are now copied into fixture builder.

27.4.10 Fixture Builder Terminology

A variety of terminology used in the fixture builder is described in this section.

DMX: represents the dmx value or range of dmx values that will output from the console when the specified real world values are programmed by the console operator. For example, a dmx channel entry with a dmx value of 0<255, a function of intensity, a feature of variable, and a real world value of 0<100% will result in a dmx output of 0 when the fixture's intensity is at 0%, a dmx output of 255 when the fixture's intensity is at 100%, and a variably scaled dmx value when the intensity is between 0% and 100%.

Function: represents the hardware component of a fixture that Hog 4 OS is attempting to control. In many cases the dmx protocol documents provided by a fixture manufacturer will list functions that are not available in fixture builder. In these cases a loose translation into an established Hog 4 OS function is required.

Feature: a sub-component of functions that further describes how the function operates in the fixture. Some functions may have multiple features. For example, Strobe is a function with multiple features including Rate, Random, and Random Sync. Function/feature pairings are the basic building blocks of a fixture type's dmx profile. Much like fixture functions, most manufacturers do not describe fixture features exactly the same as the Hog 4 OS fixture builder and a loose translation will be required.

Value: (short for real-world value) represents the programmable real world value or range of values for a given function. For example, slotted colour wheels are defined using real-world values such as "Orange" and "Congo" whereas a variable functions such as Intensity are described using real world values such as 0% and 100%. Fixture builder's pop-up menu system will suggest the most common real world value ranges but you should always attempt to input the real world values ranges that most accurately match the fixture's dmx channel documents.



Tip

Each function/feature combination used in a fixture type must be defined on all dmx channels where that function is used. For example, if strobe/rate is used on dmx channel 9 and strobe/random is used in dmx channel 10, then strobe/rate must also be defined on dmx channel 10 and strobe/random must also be defined on dmx channel 9.

Unused: if a dmx channel is unused Hog 4 OS will output a constant dmx value of 0 for the corresponding dmx channel when the fixture is patched.

Attached Channel: increases the dmx capacity of a function from 8-bit to 16-bit. For example, if dmx channel 1 is assigned to the Pan function and dmx channel 2 is attached to dmx channel 1 then dmx channel 1 will act as coarse control for Pan and dmx channel 2 will act as fine control for Pan.

Qualifiers: used to specify any conditions that must be met in order for a function/feature to output a specific value or range of values. Multiple qualifiers can be added to a single function/feature entry within a dmx channel. One example is a slotted colour wheel with offsets. In this case the main function/feature pairing is ColourOffset/Offset which is defined with dmx value range (such as 0<10) and a real world value range (such as -50% > 50%) and is qualified by ColourSlot/Index with a specific real world value (such as red). In most cases a dmx value is not required for qualifiers. Qualifiers can only be added/removed/edited in fixture builder's advanced view.

None: can be used as a dmx value to indicate that no changes will occur to the dmx output for a dmx channel regardless of whether the specified real world value conditions have been met.

ANY: can be used as a function, feature, or real world value.

- When ANY is used as a function the console will output the dmx value specified in the dmx channel entry regardless of any other conditions. Therefore, using ANY as a function for a dmx channel entry results in that dmx channel outputting a constant dmx value. The constant option in fixture builder's basic view is the same as setting the function to ANY.
- When ANY is used as a feature the console will output the dmx value specified in the dmx channel entry regardless of which feature is active in the programmer/playback. This similar to assigning ANY to a function but allows for the function to specified on the dmx channel. This is not very common.
- When ANY is used as a real world value the console will output the dmx value specified in the dmx channel entry if the specified feature is active in playback/programmer.



Tip

Fixture builder automatically creates coordinating cyan, magenta, yellow, hue, and saturation functions when I-Red, I-Green, and I-Blue constructs are described in a fixture's dmx channel description and have dmx value range of 0 thru 255 and a real world value range of 0% thru 100 %.

27.4.11 **Fixture Builder Practice Tutorial**

The following fixture builder tutorial provides step-by-step instructions for creating, building, and exporting a fixture type that is capable of controlling the essential functions of the High End Systems Uno fixture. Please refer to the DMX chart shown in the figure below as part of the tutorial.

Dmx Channel	Construct	Description	Low Decimal	High Decimal	Low Value	High Value	Default Decimal
1	Pan	Pan Course	0	255	-270°	270°	127
2	Pan	Pan Fine	0	255			255
3	Tilt	Tilt Course	0	255	-132.5°	132.5°	127
4	Tilt	Tilt Fine	0	255			255
5	Mix Color Function	RGB	0	15	-	-	0
		RBG	16	30	-	-	
		BRG	31	45	-	-	
		BGR	46	60	-	-	
		GRB	61	75	-	-	
		GBR	76	90	-	-	
		CMY	91	105	-	-	
		CYCLE	106	120	-	-	
		RANDOM	121	135	-	-	
6	● LED RED	Red LED Intensity	0	255	0%	100%	0
7	● LED GREEN	Green LED Intensity	0	255	0%	100%	0
8	● LED BLUE	Blue LED Intensity	0	255	0%	100%	0
9	○ LED WHITE	White LED Intensity	0	255	0%	100%	0
10	Shutter Mode	Normal Strobe Mode	0	31	-	-	0
		Random Strobe Mode	32	63	-	-	
		Sync Random Strobe Mode	64	95	-	-	
11	Shutter	Closed	0	23	-	-	255
		Strobe Rate (slow -> fast)	24	229	0Hz	10Hz	
		Open	230	255	-	-	
12	Dimming	Dim Coarse	0	255	0%	100%	0
13	Dimming	Dim Fine	0	255	0%	100%	0
14	mSpeed	Disabled	0	3	-	-	0
		Long -> Short	4	255	252 sec	0.15 sec	
15	Control	Safe Mode (normal operation)	0	15	-	-	0
		Pan & Tilt Speed Off	16	31	-	-	
		Display Off	32	47	-	-	
		Display On	48	63	-	-	
		Home All	64	79	-	-	
		Shutdown	80	95	-	-	

Figure 27.4. Uno DMX Chart

1. Open the fixture window (open + fixture) and click on the Fixture Builder button located at the top of the fixture window.
2. In the fixture builder window, use the "current type" drop down menu to select create new...
3. Select the summary tab in the fixture builder window and fill in the fixture information as shown in the figure below:

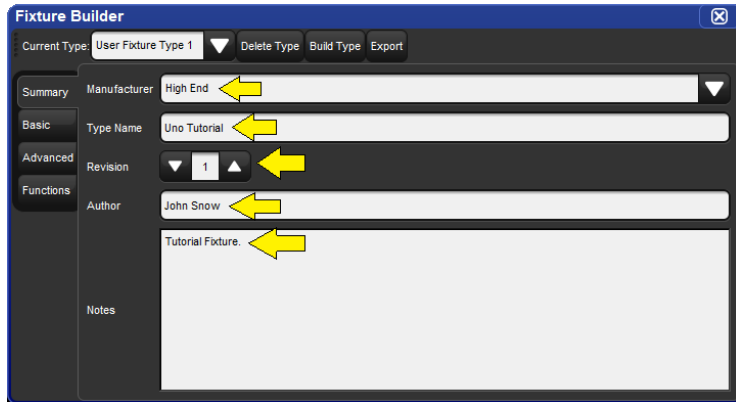

Figure 27.5. Fill in the fixture summary

4. Select the basic tab in the fixture builder window.
5. Click on the red X located to the far right of the dmx block for channel 1 to remove intensity. Click OK to confirm the remove.
6. Click on the blue plus button for channel 1. A template menu containing common fixture components will appear. Refer back to the Uno Dmx chart and look at channels 1 through 4. The first thing you'll notice is that channels 1 thru 4 control the Pan and Tilt constructs of the fixture. You'll also notice that pan and tilt each occupy two dmx channels (one for coarse control and one for fine control of each parameter). This is known as 16-bit Pan and 16-bit Tilt. Press the 16 bit button listed next to Pan & Tilt in the template menu for channel 1. Notice how fixture builder automatically fills in channels 1 thru 4. Channels 1 and 3 are labeled as Pan and Tilt while channels 2 and 4 are attached to channels 1 and 3. This is how 16-bit channels are represented in fixture builder.
7. Next we need to defined the real world values for pan and tilt. Refer to the dmx chart. As you can see no adjustments need to be made to Pan as the Uno's values happen to match the template's pre-filled values. However, you will need to type in new real world values for Tilt ($-132.5 < 132.5$).
8. Now let's move on to defining dmx channel 5. Once again, refer to the dmx chart for the Uno. Here we see that channel 5 is defined as "colour mode". Since "colour mode" is not a native function in Hog 4 OS we must use an alternative function. In this case we will use "Control Mode". Since basic view doesn't have a "Control Mode" option in the template menu we need to switch to advanced view. Click on the advanced tab in the fixture builder.
9. In the advanced view you will see a tree view of all of the dmx channels that we've specified in the fixture so far. Now we are going to add and define dmx channel 5. Click on the black header for channel 4 and then

press the Add Below button located in the edit menu on the right. This will add channel 5 to the channel tree.

10. Now we will add a series of dmx entries for channel 5. To add the first dmx entry press the Add Value button. Refer to the Uno's dmx chart. The dmx value of the first entry on dmx channel 5 is 0. Click on the dmx cell, input a dmx value of 0 and confirm by pressing the green check mark button. Next we will select "Control Mode" as the function, "Variable" as the feature, and 0 as the real world value.
11. Continue adding dmx entries to channel 5 using the "add below" button and fill in the appropriate values until channel 5 looks like the figure shown below.

The screenshot shows the Fixture Builder interface. On the left is a sidebar with tabs: Summary, Basic, Advanced, and Functions. The main area displays a channel tree with five channels: 1: Pan, 2: (attached to 1), 3: Tilt, 4: (attached to 3), and 5: Control Mode. Channel 5 is selected and expanded to show a table of DMX entries.

Channel	DMX	Function	Feature	Value	
1: Pan					
2: (attached to 1)					
3: Tilt					
4: (attached to 3)					
5: Control Mode					
	Value	0	Control Mode	Variable	0
	Value	16	Control Mode	Variable	16
	Value	31	Control Mode	Variable	31
	Value	46	Control Mode	Variable	46
	Value	61	Control Mode	Variable	61
	Value	76	Control Mode	Variable	76
	Value	91	Control Mode	Variable	91
	Value	106	Control Mode	Variable	106
	Value	121	Control Mode	Variable	121

Figure 27.6. Fixture Builder Tutorial, Uno Channel 5

12. Now let's go back to basic view and add a definition for dmx channel 6. Click on the Basic tab.
13. Click on the blue plus button in the "Add channel" rectangle to begin defining channel 6. Once again we need to refer to the dmx chart. Here we see that channels 6 thru 10 control the I Red, I Green, I Blue, and I White functions of the fixture. Let's quickly assign channels 6 thru 9 to these functions by choosing the RGBW component from the basic view's template menu. The fixture builder will automatically fill in the function definitions for channels 6 thru 9.
14. Now we move on to dmx channel 10. As you can see in the dmx chart, channel 10 is a shutter (strobe) channel. Press the blue plus button in the "Add channel" rectangle, then press the Basic button in the Strobe section of the template menu. This will auto-populate channel 10 with a few strobe function/feature combinations. Since these entries don't match the dmx profile of the Uno, we will need to edit them.

15. Refer back to the dmx chart. The Uno has three different strobe modes defined in channel 10. Each of these modes (or features) needs to be added to channel 10 in the fixture builder. Since these entries only establish the strobe modes (features) and do not specify a real world value, each entry should have a real world value of ANY. Once you are finished, channel 10 should look like the figure below.



Figure 27.7. Fixture Builder Tutorial, Uno Channel 10

16. Now click on the blue plus button in the dotted "Add channel" rectangle to add channel 11 to the fixture. Refer to the dmx chart. As you will see channel 11 also controls the strobe function of the fixture but more specifically controls the rate of each strobe mode. Channel 11 also has a shutter open and shutter closed value. We are going to use the Complex strobe option from the template menu in basic view to establish a starting point for editing channel 11. Use the graphical interface in basic view to make dmX channels 10 and 11 to look like the figure below.

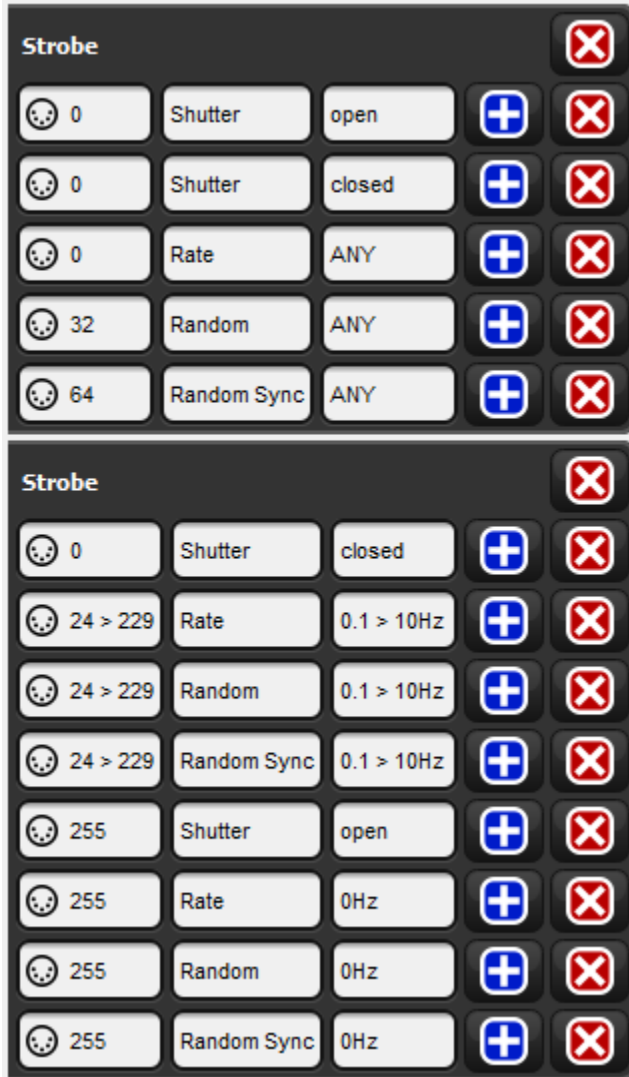

Figure 27.8. Fixture Builder Tutorial, Uno Channels 10/11

17. You might be questioning why we added a strobe/shutter definition to dmx channel 11 and channel 10. The reason is that Hog 4 OS must initialize every function/feature pair for all channels that refer to a specific function.
18. By now you should be getting the hang of adding and removing dmx channels and dmx entries. Let's move forward with adding and defining channel 12 using the 16-bit intensity component from the template menu. The reason we are using the 16-bit intensity component is be-

cause the fixture's intensity parameter is split into two dmx channels. Much like 16-bit Pan and 16-bit Tilt, the first dmx channel in the intensity's definition is for coarse control while the second dmx channel is for fine control.

19. Now we are ready to define channel 14 of our fixture which is mSpeed. Controlling the fixture's mSpeed value is NOT necessary since Hog 4 OS has it's own programmable timing for every function and feature. Therefore, channel 14 should be assigned to a "Constant" dmx value of 0. Select Constant in the template menu and set the dmx value to 0. This will ensure the fixture's mSpeed is always set to 0 seconds.
20. Finally we've reach channel 15. Look at the dmx chart. Channel 15 is a control channel. Click on the blue plus button in the dotted "Add channel" box to add channel 15.
21. Select Fixture Control from the template menu. Use the fixture builder basic view to edit the dmx entries for channel 15 so that they match the dmx protocol.

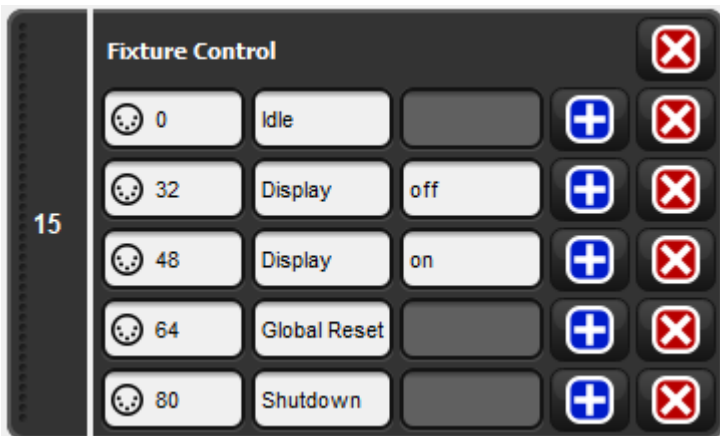

Figure 27.9. Fixture Builder Tutorial, Uno Channel 15

22. Congratulations! You have now finished defining all of the dmx channels of the Uno tutorial fixture.
23. Select the Functions tab of the fixture builder. The functions tab lists all of the fixture's functions and features in an easy to read spreadsheet. The default values and virtual intensity assignments can also be edited using the functions view.
24. The Uno has dedicated 16-bit intensity functions assigned to dmx channels 12 and 13, which means we do not need to add virtual intensity to the Uno profile. Un-check the virtual intensity option for all functions.
25. The default features and default real world values also don't need to be altered since the Uno's dmx profile matches the pre-populated de-

fault values provided by the console. However, it might be good idea to experiment with changing the defaults as a part of your learning experience with this tutorial.

26. The next step is to build the fixture type so that it can be scheduled and patched in the current show file. Press the Build Type button located at the top of the fixture builder window. If fixture builder finds any errors a dialogue box will pop up and the build process will fail until you correct the errors.
27. When the fixture build succeeds a prompt will appear alerting you that the build was successful.
28. Open the fixture window and click on the "Fixture Schedule" button. Use the fixture schedule dialogue to search for the fixture type you created. It should show up as "Uno Tutorial" and be listed under the High End manufacturer. An icon indicating the fixture was built in the fixture builder will also be displayed next to the fixture name. Schedule and patch the fixture to the appropriate dmx output and begin testing the fixture profile with a real fixture if available. The dmx window is another way to verify the dmx output is working as expected when controlling the fixture.
29. Once you have tested the tutorial fixture you can export it to a fixture library so that it can be used across consoles and with different show files. To export the fixture type to a fixture library select the fixture in the fixture builder using the current type drop down menu and press the export button at the top of the fixture builder window. When the file browser pops up, select a name for the library and press okay. This will export the fixture type into a new fixture library which will be located in the library folder of the console.
30. To copy the fixture library to a USB flash drive go to the open the shows window (setup, shows) and select the File Browser tab. Drag the fixture library from the libraries folder on the console to the USB drive. You will be prompted to name the library archive. Give the library archive a name and press OK. The fixture library is now written on the USB flash drive. The library archive can be installed on any console running Hog 4 OS v3.9.0 or greater using the steps outlined in the *Download and Install Fixture Libraries (p.419)* section of this help manual.

Section 28: Visualizer Connectivity

28.1 Connectivity Overview

In addition to Art-Net, sACN, and DMX, Hog 4 OS consoles can control visualizers through a direct visualizer stream via the console's FixtureNet port. For most applications this requires installation of the Hog 4 Connectivity Driver on the visualization computer. Installation of the Hog Connectivity Driver is not required if running Capture v2019.0.13 or greater since CITP is supported for Hog visualizer streaming.

This section describes how to install the Hog 4 Connectivity application on your visualiser computer, how to physically connect the console to the visualizer PC, and how to configure both the visualizer PC and Console to enable direct Hog Visualizer Connectivity.

Visualizer applications that support direct Hog Visualizer streaming:

Capture: www.capturesweden.com

Light Converse: www.lightconverse.com

Martin Show Designer: www.lighthouse.nl

Vectorworks Vision: www.vectorworks.net/vision

WYSIWYG/Cast: www.cast-soft.com

For visualizer product information, software licensing, and instructions on visualizer operation, please contact the visualizer manufacturer directly.

28.2 Installing the Hog Connectivity Driver on the Visualizer PC

The current Hog 4 Connectivity installation application can be downloaded from the High End Systems website: www.highend.com. The connectivity driver is also automatically installed with Hog 4 PC. Installation of the Hog Connectivity Driver is not required if running Capture v2019.0.13 or greater since CITP is supported.

To install the connectivity application using the dedicated installer:

1. Double click the HogConnect_x-x-x-x.msi file to launch the install wizard.
2. The Hog Connect installer will check your operating system and windows installer versions, and then display the welcome screen. Press Next to begin the installation process.

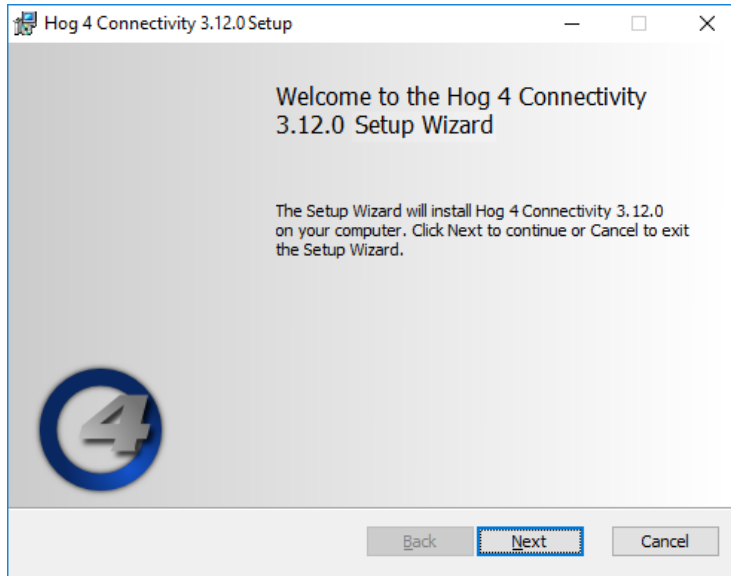

3. The wizard displays an End User License Agreement. Select *I accept the terms in the License Agreement* and then press Next to continue.

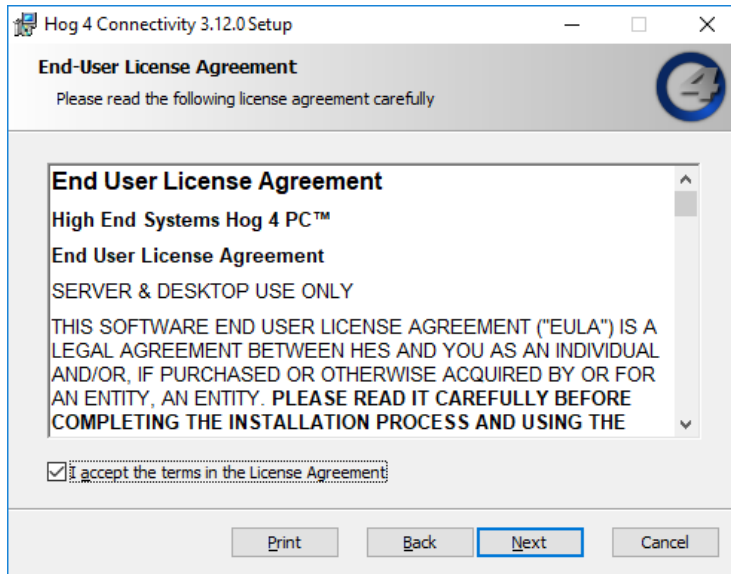

4. A *Ready to Install* screen will appear with instructions on beginning or canceling the installation. Press Install to begin installing.

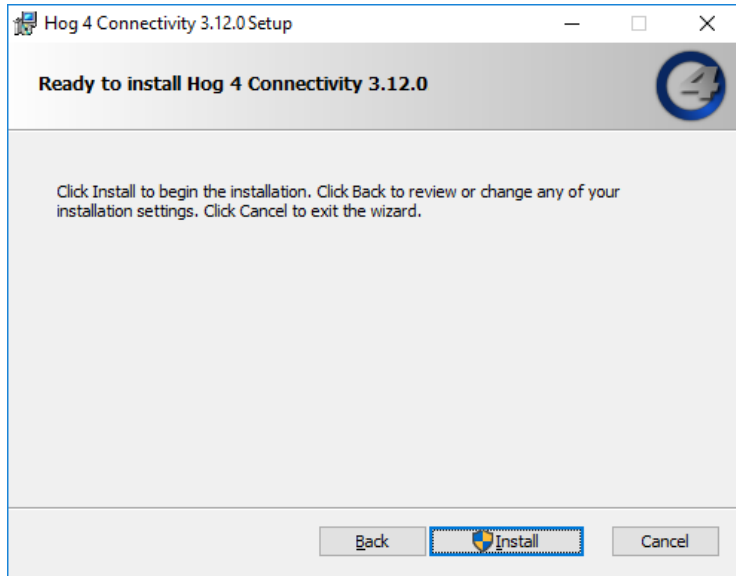

5. The installation only takes a few seconds. When the installation is complete, press Finish to exit the installer.

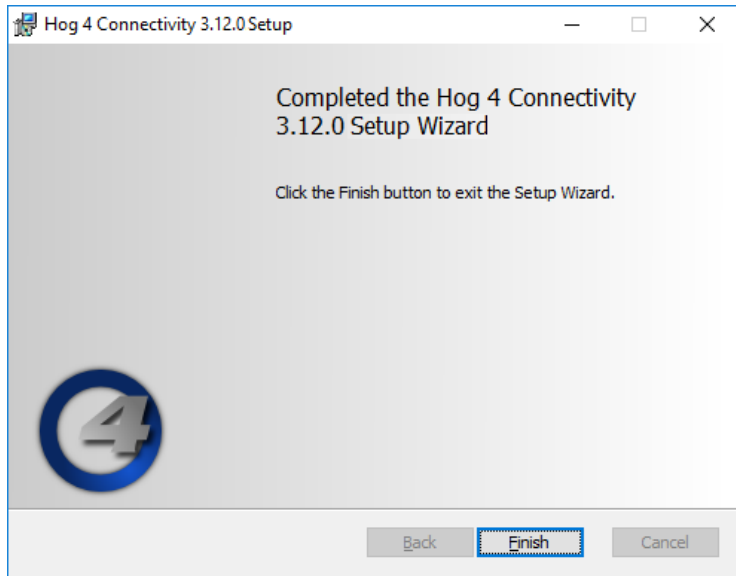

28.3 Physically Connecting the Console to the Visualizer

- Connect the console's FixtureNet port to any Ethernet port on the visualizer PC using a standard Cat5 or Cat6 Ethernet cable. Switches and routers can also be used inline to connect the console to the visualizer PC.

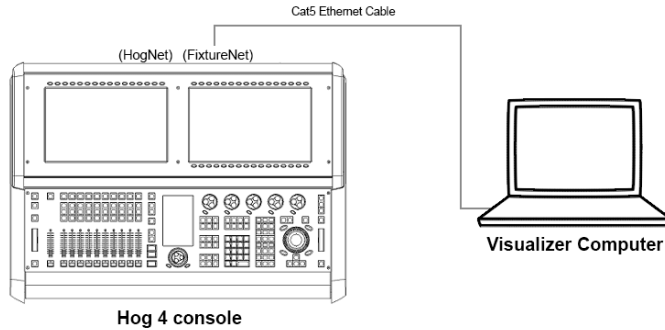

28.4 Configuring the Visualizer PC for Connectivity

28.4.1 Network Settings on the Visualizer PC

1. Navigate to the network and sharing center of your Visualizer PC by right clicking on the network icon on the windows desktop and select properties. If the network icon is not shown on your desktop then do a search for "network and sharing center" on your PC and click on the appropriate search result to open the network and sharing center window.
2. Click on "change adapters settings" located in the left hand pane of the network and sharing center window.
3. Ensure that the network adapter associated with the Ethernet port you connected the Cat5 cable to is enabled and assigned an IP address that is within the same sub-network as the console's FixtureNet port. This can be accomplished by assigning the network adapter a static IP address or by using a DHCP router in the network and assigning the

network adapter to "obtain an IP address automatically". A typical static IP address configuration is shown in the image below.

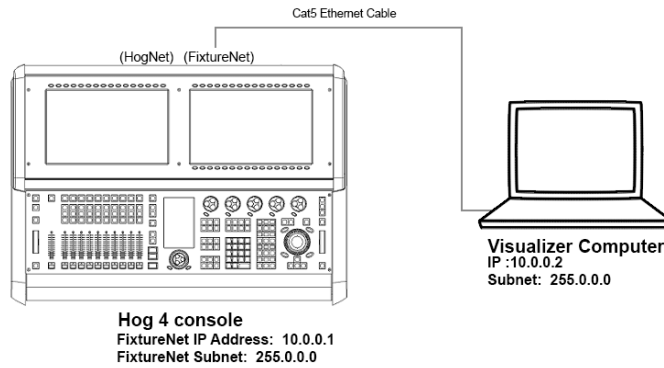

Note: In some cases it may be necessary to also right click and disable the other network adapters including bluetooth and wireless network adapters to ensure the visualizer application is sending data to the appropriate network adapter.

28.4.2 WYSIWYG Configuration

To configure WYSIWYG:

1. In WYSIWYG open the Device Manager : Live → Device Manager

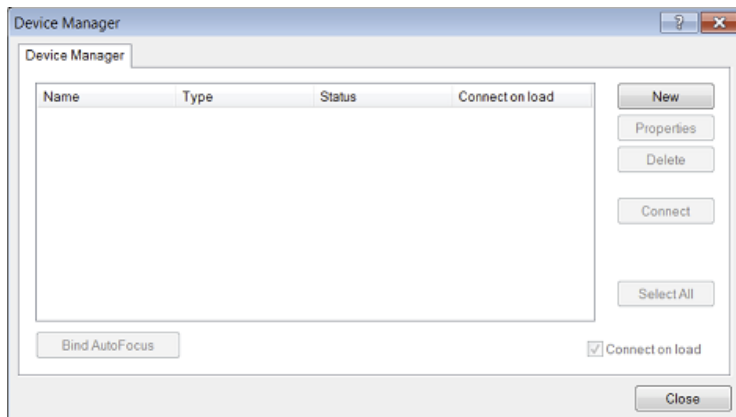

2. Click on New to add an additional device. Select Wholehog DP8000 as the new device:

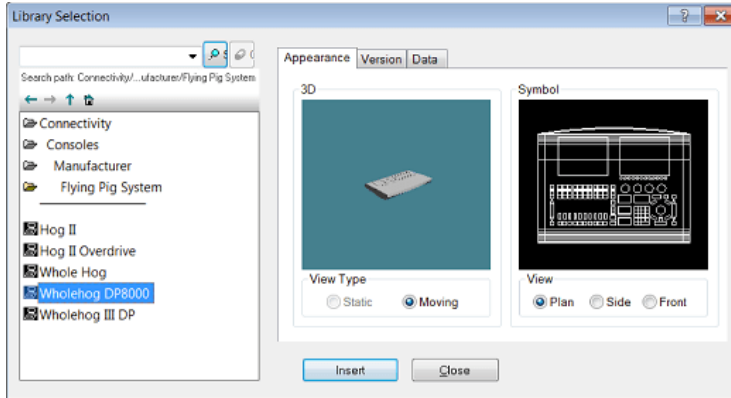

3. The device window will now display the Wholehog DP8000,

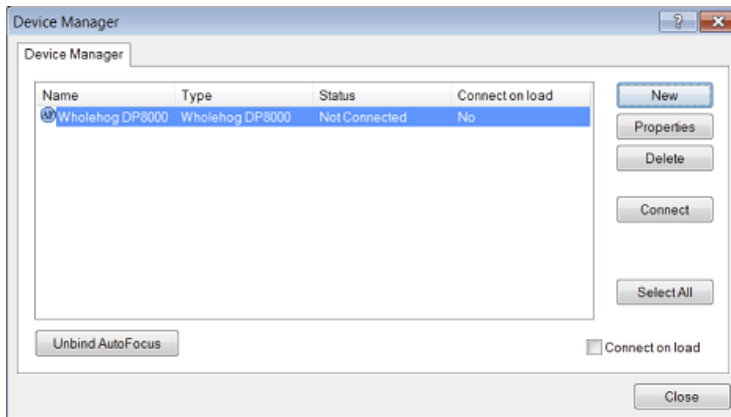

Double click on this device or select it and press Properties. The Properties window will open:

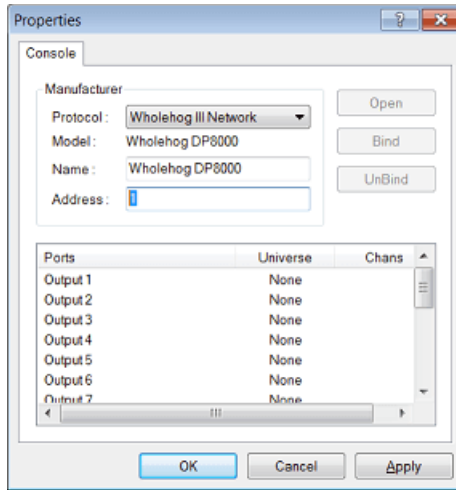

4. In the Address field enter a value of 1,2,3, or 4. If you enter a value of 1 then the output ports listed below will act as Hog visualizer outputs 1>16. If you enter an address value of 2, then the output ports displayed below will be interpreted as Hog visualizer outputs 17-32 although they are labeled output ports 1<16. Click OK to close this window.
5. Bind the Hog output ports to the universes in your WYSIWYG show.

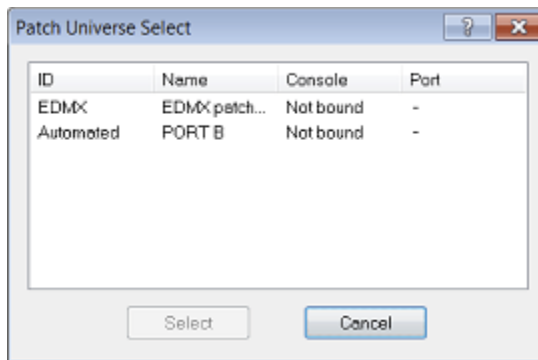

6. Once the universes are bound to the DP8000, press the connect button in the device manager window.

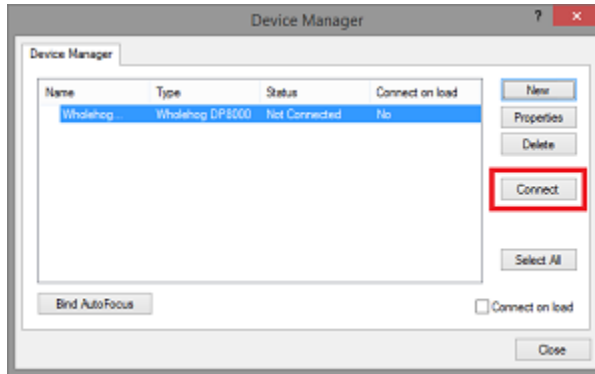

The DP8000 will now show a "connected" status which indicates that WYSIWYG is now ready to receive a visualizer data stream from a console. Please note that the "connected" status does not mean WYSIWYG is receiving a visualizer stream from a console. Proceed to *Physically Connecting the Console to the Visualizer* (p.440) for instructions on how to configure the console to send a visualizer data stream into WYSIWYG.



Tip

Select the "connect on load" option in the device manager window of WYSIWYG to avoid having to manually press the connect button each time you load that particular WYSIWYG project file.

Also, click on the "Bind AutoFocus" option in WYSIWYG's device manager to enable the Autofocus feature described in *Autofocus* (p.449)

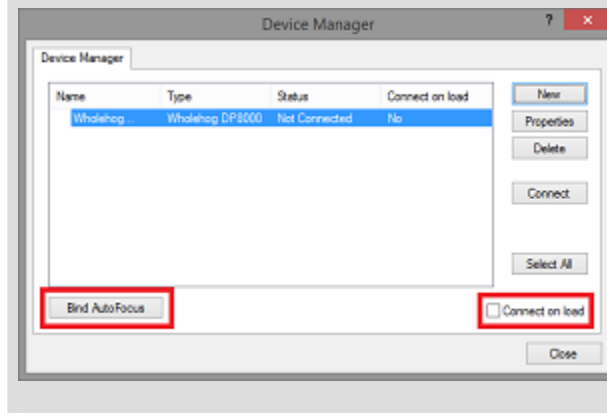

28.4.3 WYSIWYG Console Edition Configuration

When using some versions of Console Edition (CE) WYSIWYG to connect directly to a Hog system only one universe of visualization is possible at a time. If your version of

CE is limited to one universe, you will need to specify which universe is active within the WYSIWYG file:

1. With the WYSIWYG file open, go to the Live Module and select Edit → Universes.
2. The Visualization Universe Selection window will open. This window will display all the currently configured universes within your drawing. Use this window to select the universe you wish to visualize from the console.



28.4.4 Vectorworks Vision Configuration

Set the dmx provider in Vectorworks Vision to the Hog connectivity driver using the following steps:

1. Click the "Dmx" option at the top of the Vision Window and select the "Change DMX Provider" menu option.

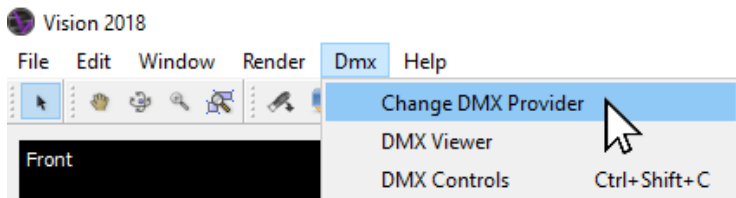

2. In the "Select DMX Provider" pop up menu select "Hog Net" and click okay.

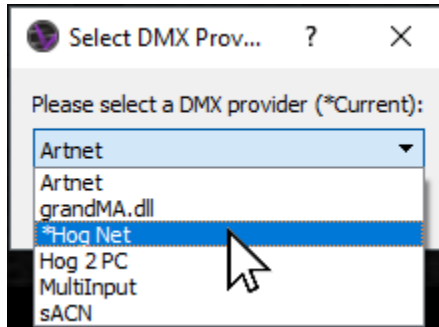

28.4.5 Capture Configuration

Capture 2018 older:

- Installation of the Hog Connectivity Driver on the visualizer computer is required.
- On the console select the "Hog Connectivity" protocol and "Capture" manufacturer in the visualizer node settings
- In Capture set the project console link and universe bindings to "Auto" or "Hog 3/4" when available.

Capture v2019.0.13 and greater:

- Hog Connectivity and CITP protocols are both supported for Hog visualizer streaming.
- Installation of the Hog Connectivity driver is not required if the CITP protocol is used.
- The CITP visualizer streaming protocol is compatible with Hog 4 OS consoles and both the Windows and Macintosh versions of Capture as well as Presentation files generated by Capture v2019.0.13 and greater.
- In Capture set the project console link and universe bindings to "Auto".

28.5 Configuring the Console for Visualizer Connectivity

28.5.1 Enabling the Visualizer Stream on the Console

1. Navigate to the start screen of Hog 4 OS and click on the settings button.
2. Enable the "Run Visualizer Stream" button and click okay.

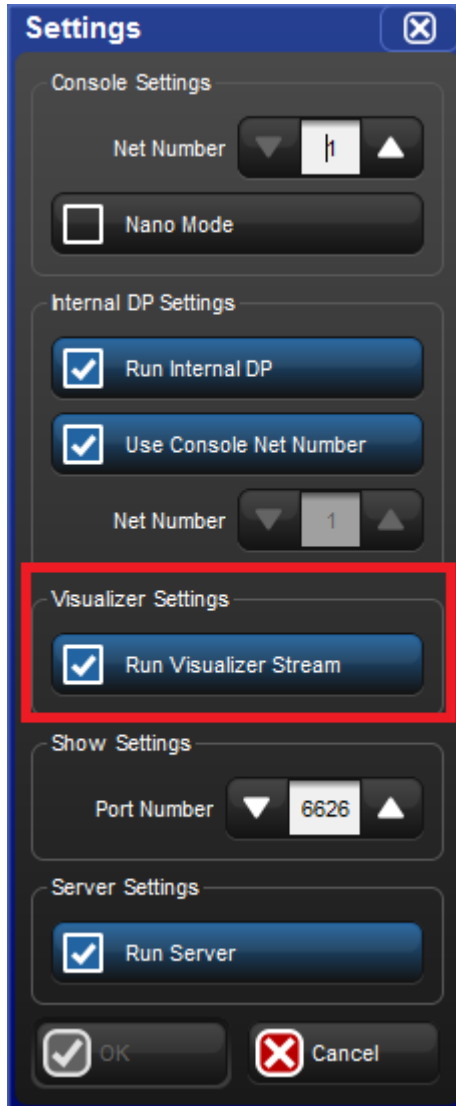

28.5.2 Configuring a Show for Visualizer Connectivity

1. Load a new or existing show file on your console.
2. Open the network window (setup, network).
3. Click on the visualizer node listed in the network window.
4. Click on the settings button located at the top of the network window. This will open the visualizer settings window.

5. Enter the IP address of the visualizer PC into the "visualizer IP address" field.

If a visualizer is already running on the network you can use the "detected visualizers" drop down menu to auto-populate the IP address and visualizer protocol and manufacturer fields.

In you are using WYSIWYG, all steps listed in *WYSIWYG Configuration* (p.441) must be completed in order for WYSIWYG to be listed as detected visualizer.

6. Select the appropriate visualizer protocol and manufacturer using the drop down menus. Use of the CITP protocol for visualizer streaming to Capture requires Capture Version 2019.0.13 or greater.
7. The Hog 4 visualizer connectivity supports multiple DMX Processors dependent upon the number of universes supported by your visualizer and/or license. You can connect any universe on any of the patched DPs within your show to any universe within the visualizer. For example, to assign visualizer universe 3 to respond to output from DMX Processor 2 universe 3, simply locate DP# 2, Universe 3 in visualizer node settings window, click on the button and select 3.

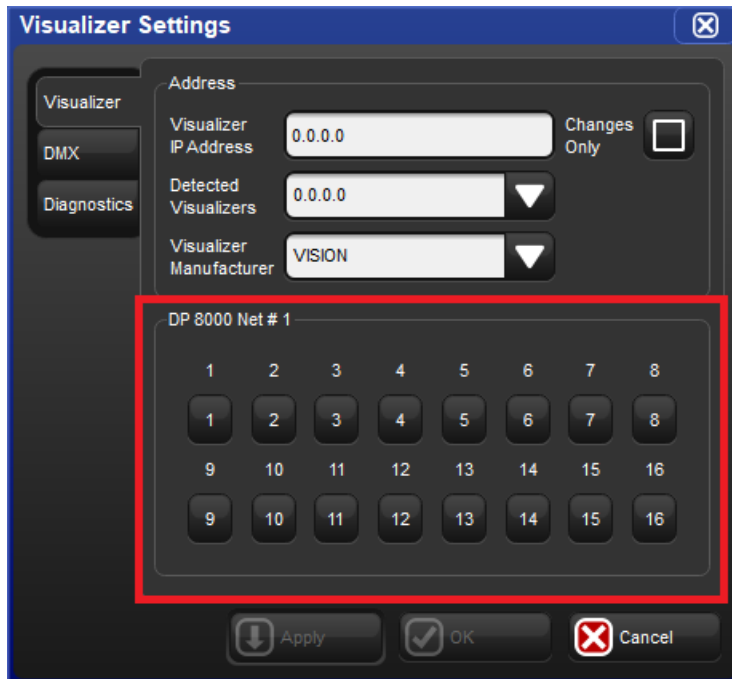

8. Click okay to apply the changes. If your show file is appropriately patched and your visualizer is running and assigned to listen to Hog

connectivity input then you should now have control over the visualizer from you console.

28.6 Autofocus

Visualizers can send information back to your Hog console to allow lights to be automatically positioned to a particular location on stage, rather than individually positioning the fixtures using the console's controls. This feature is called Autofocus and works when using the Hog Connectivity protocol for visualizer streaming.

When Autofocus is properly enabled and configured, selecting and deselecting fixtures as well as assigning intensity, iris, pan, tilt, and CMY colour mixing values to fixtures in the visualizer application results in those same selections and values appearing in the active editor or programmer on the Hog console.

Please refer to the users manual for each respective visualizer application for further details on how to enable and configure visualizer files to utilize the Autofocus feature.

28.7 Visualizer Troubleshooting

- 1. The visualizer node is showing as "idle" or "offline" in the network window.**

Ensure that the "Run Visualizer Stream" option is turned on in the settings window of the Hog 4 OS start screen.
- 2. The visualizer node is not appearing in the network window.**

Ensure that the "Run Visualizer Stream" option is turned on in the settings window of the Hog 4 OS start screen.
- 3. WYSIWYG isn't showing up in the "detected visualizers" drop down menu of the visualizer node settings window.**

Go to WYSIWYG and open the device manager window. Ensure all listed DP8000s show a status of "connected". If the listed DP8000s show a status of "connected" and the console still isn't auto-detecting WYSIWYG in the visualizer node settings window, then proceed with manually entering the IP address of the WYSIWYG computer and select WYSIWYG from the visualizer manufacturer. Auto-detection may not be supported by your network's configuration.
- 4. The visualizer node is running but there appears to be a noticeable delay in responsiveness in the visualizer.**

If you are using the Hog Connectivity protocol then turn off all art-net output from the console's internal DP8000. A lack of responsiveness can also be due to an underpowered graphic card installed on the visualizer machine.

5. **The visualizer node is running but I am getting garbled fixture output in the visualizer.**

Ensure that the correct visualizer manufacturer and protocol is selected in the visualizer node settings window on the console. Then check that the universe patch settings for each DP and universe are set appropriately in the visualizer node settings window on the console. If using the CITP visualizer streaming protocol with Capture ensure that capture 2019.0.13 or greater is installed.

6. **The visualizer node is running but I am getting absolutely no output data in the visualizer.**

Ensure that the visualizer IP address and manufacturer settings are correct in the visualizer node settings window on the console.

For WYSIWYG, ensure the DP8000s listed in the device manager show a status of "connected".

7. **I've tried everything and the settings all look correct in the console and in the visualizer application but it still isn't working.**

Ensure that the visualizer's IP address and console's IP address are set within the same subnetwork. If you are unsure what this means then try using the IP address settings from the example figure in section 29.3 and try again. If you continue to have trouble contact HES support for further assistance.

Section 29: Updating Software

29.1 Console Software Update

Hog console software can be updated using an fspkg update installer package downloadable from the High End website. Hog 4 PC is upgraded using an separate installer package. For details on installing/upgrading Hog 4 PC see *Hog 4 PC* (p.467).



Caution

Updating console software removes all manually installed fixture libraries from the console.

To update software on a Hog 4 Series Console:

1. Download the latest Software update installer from the High End website (once downloaded the file name will be Hog4_X-X-X.fspkg where the Xs represented the software version number). Be sure to also check the release notes for the specific software version as special install instructions may also apply.
2. Copy the software update installer file to a USB Flash drive.
3. Insert the USB Flash drive containing the software update file into any USB slot on the console.
4. Press the Software Update button located at the bottom of the start window.
5. Browse to the USB flash drive and select the appropriate software update file, and press OK.
6. Hog 4 OS will continue with the software upgrade without further interaction. Upgrades typically take less than 25 seconds to complete unless otherwise noted in the release notes. When the upgrade completes, all dialogue boxes will close and the start screen will reappear. Check the splash screen to ensure the console is running the upgraded software version.

29.2 Console Software Full Install

Occasionally a 'full install' of the Hog 4 OS may need to be performed on a console. Performing a full install completely erases and replaces the Hog OS core operating system and clears the console of any saved show files. A full install is not typically required to update console software unless specified in the release notes. In some cases a full install may be advised by support staff as a measure to restore console functionality.



Important

Before installing new software, ensure that all show data is backed up. A Full Install will erase all data on the console's hard drive.

To perform a full install:

1. Ensure that all show data is backed up onto an external media device as the full install procedure will clear all show data from the console. See *Backing Up Your Show* (p.95).
2. Power OFF the console.
3. Download the latest Full Install file from the High End Systems website.
Note: The Hog 4 OS full install file has an .iso file extension.
4. Create a Full Install USB flash drive. Refer to *Create a Full Install USB Flash Drive (Hog 4 OS v3.9.0 and newer)* (p.454) for instructions.
5. Insert the Full Install USB flash drive into one of the USB ports on the console. Do not use the USB ports located in the front drawer of Hog 4-18.
6. Connect an external USB keyboard to the console. The built-in keyboard on the Hog 4 and Hog 4-18 can be used.
7. Power ON the console.
8. Wait for the "System Installation" screen to appear.
9. To begin the software installation process press Enter on the external USB keyboard.
-Or- use the touchscreen or trackball to click the "continue" button.
-Or- use the enter key on the console's front panel if the blind key is flashing.
10. The installation will now take several minutes to complete.
11. When the installation procedure is complete a "console installation complete" message will appear.
12. Remove the Full Install USB flash drive from the console.
13. Press the Enter key on the external USB keyboard.

-Or- use the touchscreen or trackball to click the "continue" button.

-Or- press the [enter] key on the console's front panel if the [blind] key is flashing.

14. The console will now reboot and the newly installed software will now run.

29.3 Create a Full Install USB Flash Drive (Hog 4 OS v3.9.0 and newer)

The following procedure demonstrates how to create a Full Install USB flash drive for use with all Hog 4 OS Consoles.

This procedure is only compatible with Hog 4 OS v3.9.0 full installations and newer.

This procedure is NOT compatible with Hog 4 OS v3.8.0 and older.

For full installs of Hog 4 OS v3.8.0 and older please refer to *Create a Full Install USB Flash Drive (Hog 4 OS v3.8.0 and older) (p.455)*.

1. Download and install the Etcher application to your Windows PC or Macintosh Computer. (<http://www.etcher.io/>)
2. Insert a 2GB or larger USB flash drive into one of your computer's USB ports and make sure it is the only external USB drive connected to your computer.
3. Launch the Etcher Application.
4. Click the "select image" button in the Etcher application.
5. Use the file browser pop-up to select the full restore file that you downloaded from the High End Systems website.
6. Click the FLASH button in the Etcher application.
7. When Etcher has finished flashing the USB flash drive a "Flash Complete" message will appear.
8. Remove the USB flash drive from the computer. Don't worry if the USB flash drive led is flashing.
9. Proceed with step four of the full install procedure: *Console Software Full Install (p.452)*.

29.4 Create a Full Install USB Flash Drive (Hog 4 OS v3.8.0 and older)

The following procedure demonstrates how to use a Windows Computer to create a Full Install USB flash drive for use with all Hog 4 OS Consoles.

This procedure is NOT compatible with Hog 4 OS v3.9.0 or newer.

For full installs of Hog 4 OS v3.9.0 and later please refer to *Create a Full Install USB Flash Drive (Hog 4 OS v3.9.0 and newer)* (p.454).

1. Download and install Linux Live's "USB Stick Maker" to your Windows PC. (<http://www.linuxliveusb.com/>)
2. Insert a 2GB or larger USB flash drive into one of your Windows computer's USB ports.
3. Launch the Linux Live USB Creator application.
4. In step 1 of Linux Live select the USB flash drive that you plugged into the computer.
5. In step 2 of Linux Live click on the ISO/IMG/ZIP button.
6. Use the browser that pops up to select the full restore file you downloaded from the HES website.
7. Skip step 3 of Linux Live.
8. In step 4 of Linux Live enable the following options:
 - Hide created files on key
 - Format the key in Fat32
9. Click on the lightning bolt in step 5 of Linux Live.
10. A notification will pop up warning you that your USB flash drive contents will be erased. Click okay.
11. When Linux Live is finished it will alert you.
12. Remove the USB flash drive from the computer.
13. Proceed with step four of the full install procedure: *Console Software Full Install* (p.452).

29.5 DMX Processor Software Update

When updating console software it is also necessary to update the software on all attached dmx processors as well.

1. Connect the console's HogNet Ethernet port and the Dmx Processor's HogNet Ethernet port to the same physical Ethernet network.
2. Ensure the console and the DMX Processor are both powered on, set to the same port number, and have their HogNet adapters set to IP addresses that are within the same subnetwork.
3. On the console: Setup → Network : (opens the Network window).
4. The network window will display any connected dmx processors that have a mismatched software version under the "Upgradeable Nodes" section.
5. Press the upgrade nodes button at the top of the network window.
6. All attached nodes requiring an upgrade should begin and finish the upgrade process within 2 minutes.
7. If the dmx processor upgrade is failing or if the console does not recognize the DMX Processor then proceed to the next step.
8. Turn off the mains power to the dmx processor.
9. Load a new show on the console and open the control panel window. (Setup -> Control Panel).
10. Navigate to the network tab in the control panel and ensure that the "Enable DHCP Server" and "Enable Boot Server" buttons are enabled.
11. With the dmx processor still turned off, hold down the all three front panel buttons and then power the dmx processor on. The display should now read "Forcing software reload".
12. The dmx processor will download its software from the console and reboot. The DP's net number and port number settings will be set back to defaults.
13. If the dmx processor still isn't updating then try performing a DMX Processor Full Install.

29.6 DMX Processor Software Full Install

The following procedure will install a full copy of the DMX Processor software onto the DMX Processor. The procedure is usually only necessary in cases where software updates are failing or when the compact flash drive inside the DMX Processor has been replaced.

1. Insert a USB Flash drive with at least 1 GB of total capacity into a Windows PC running Windows 7, Windows Vista, or Windows 10.
2. Hold the Windows key on your keyboard and then press the R key.
3. In the run dialogue box type "cmd" and press enter (allow permissions if prompted). A black command line terminal window will open.
4. At the command prompt window type "diskpart" and press enter.
5. At the diskpart> prompt type "list disk" and press enter.
6. Look at the disk size to determine which disk is the USB flash drive.
7. Type "select disk #" where the # is the disk number. Then press enter.
8. Type "clean" and press enter.
9. Type "create partition primary" and press enter.
10. Type "active" and press enter.
11. Type "exit" and press enter.
12. Open a file browser window and identify the drive letter associated with the USB flash drive.
13. Go back to the command prompt window and type "format ?: /fs:fat32 /q" (replace the ? with the drive letter for the USB flash drive as identified in the previous step).
14. Type "DP_RESTORE" as the text label for the volume and press enter.
15. Download the latest DP8K Restore zip file from the DMX Processor product page on the High End Systems website.
16. Unzip the DP8K Restore zip file onto the USB flash drive (note: the extracted files should be in the root directory on the USB flash drive and not in a folder)
17. Remove the USB flash drive from the Windows PC and insert the USB flash drive into one of the USB ports on the back of the DMX Processor.
18. Power off the DMX Processor.
19. Power on the DMX Processor (do not press any buttons on the front panel of the DMX Processor while powering on).

20. The DMX Processor will automatically perform a full software install. This process will take approximately 2 minutes to complete. Once complete the display will read “HES: Remove External USB”.
21. Remove the USB Flash drive from the dmX processor. The DMX Processor will now reboot.
22. The DMX Processor is now ready for normal operation. Please note that you will need to reset the port number, net number, and IP address settings on the DMX Processor, as these are lost during the full install process.



Warning

Do not leave the USB stick created in this procedure plugged into a DMX processor during normal operation as this will cause an unwanted software install each time the DMX processor is reset.

29.7 Upgrading HedgeHog 4 Consoles (2015 and later)

All HedgeHog 4 consoles manufactured in January 2015 or later that have the motherboard back plane exposed on the rear of the console are built using the exact same internal and external hardware. Therefore, the platform (or model) of the desk is not determined by the physical components of the desk but rather by an encrypted software certificate installed on the console. This allows any HedgeHog 4 console manufactured in January 2015 or later that has its motherboard back plane exposed on the rear of the console to be upgraded/ downgraded to any one of the platforms listed in the table below without the need for new hardware or physical changes to the desk.

Platform (model)	HogNet Enabled?	External Monitor Enabled?	Fixture Net	DMX
HedgeHog 4	NO	YES	4 universes	4 universes
HedgeHog 4S	NO	YES	4 universes	4 universes
HedgeHog 4N	YES	YES	4 universes	4 universes
HedgeHog 4X	YES	YES	6 universes	6 universes

To change the platform (model) of a HedgeHog 4 console manufactured in January 2015 or later:

1. Power on the HedgeHog 4 console. Press the Control Panel button on the start screen to open the control panel.
2. Navigate to the diagnostics tab of the control panel window. Press the Console Upgrade button.
3. The console upgrade utility wizard will now appear. Press Next to begin.
4. Select the platform (model) you wish to upgrade to and press Next.

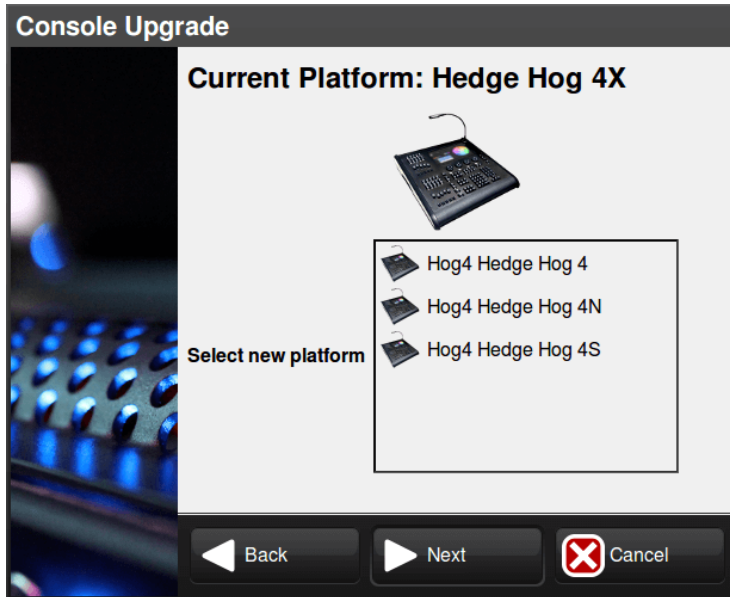

5. Contact a High End Systems Sales representative and provide them with the upgrade code shown on the screen as well as which console platform (model) you are upgrading from and which console model you are wanting to upgrade to. The High End Systems sales representative will provide you with the current pricing for the upgrade and will process your order.

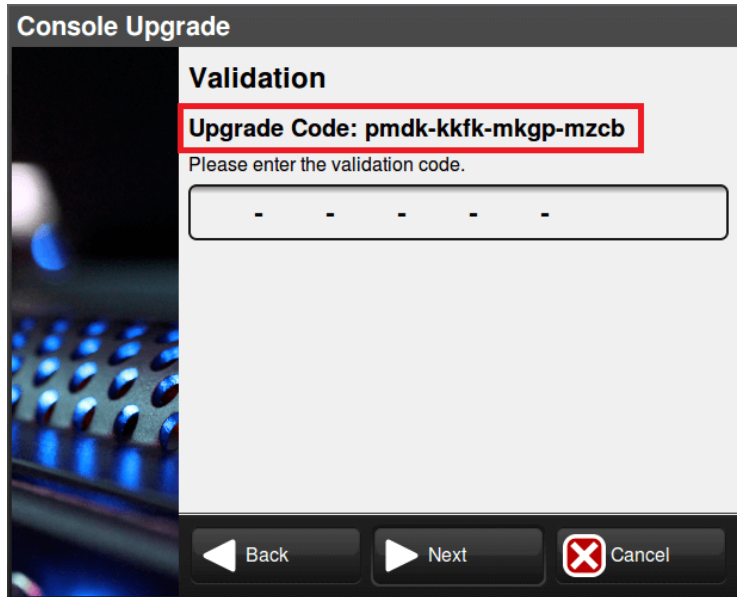

6. Once your HedgeHog 4 upgrade order is complete, High End Systems will send you a validation code. Enter the validation code into the upgrade wizard and press Next.

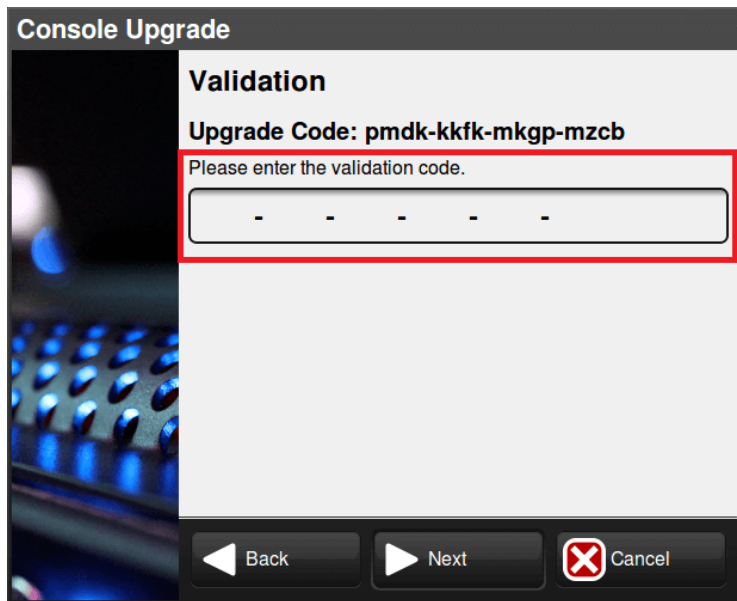

7. Press the Finish. The console will now reboot and operate as the new platform (model).

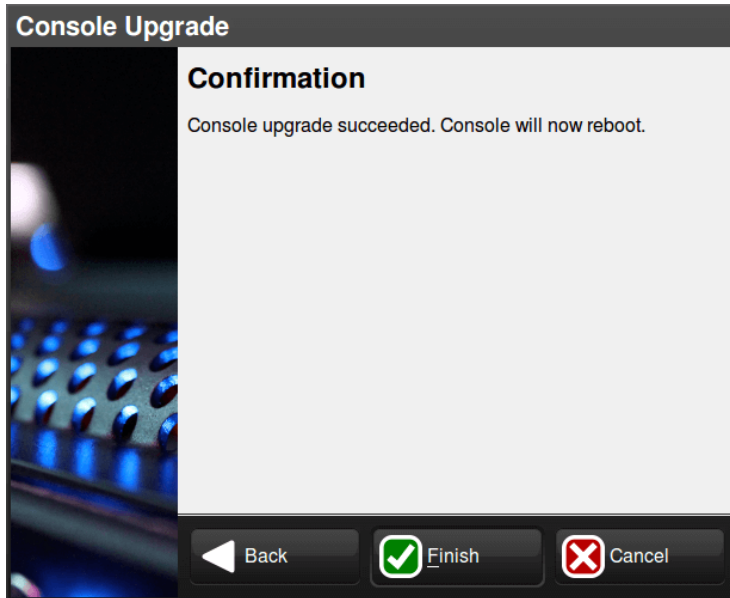

29.8 Upgrading Hog 2 USB DMX Widgets

Some older USB DMX Widgets (single universe) are compatible only with Hog 2. These USB DMX widgets will need to be upgraded to be compatible with Hog 4 OS. Please contact your High End Systems dealer for pricing and details. When purchasing, you need to provide your Widget serial number and Widget ID number. Once the upgrade is purchased, you will receive an Upgrade Kit for each USB DMX Widget. This kit contains labeling, hardware, software, and a unique authorization code compatible only with the specified widget serial number.

After receiving your upgrade kit, follow these steps to upgrade your USB DMX Widget:

1. Connect your USB DMX Widget(s) that match the serial numbers on the included authorization sheet to your Hog 4 OS console or Windows PC running Hog 4 PC.
2. Press the control panel button in the start screen of the Hog 4 OS. Navigate to the diagnostics tab of the control panel and press the Widget Upgrades button.
3. The widget upgrade utility wizard will now appear. Press Next to begin.
4. Select a Widget ID number from the drop down menu. To confirm the identity of the selected widget, press the Beacon button to flash the LEDs on the widget. If the drop down menu displays 'No DMX Widgets found!'; check your USB connections. Press Next to continue to the next step.

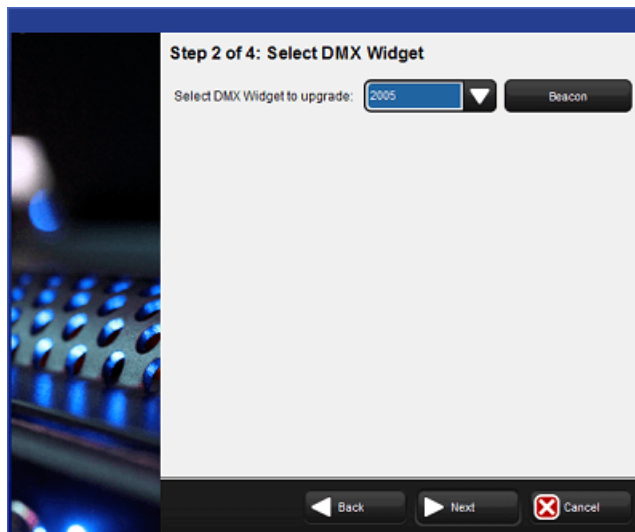

5. Enter the authorization code for the selected widget and press Next (the authorization code is delivered with the Widget Upgrade Kit). If the code is incorrect an error message will be displayed. Re-enter the proper authorization code. Codes are unique for each USB DMX Widget and will not function unless they match the expected serial number and Widget ID number.

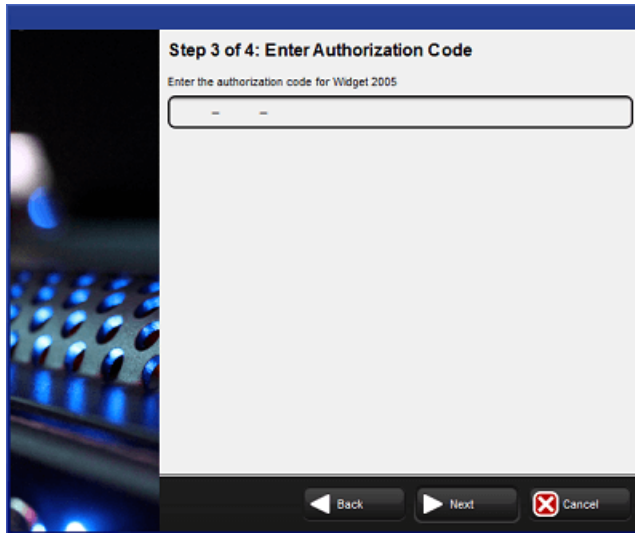

6. Once complete, the widget will be fully upgraded. You can now select Upgrade Another to upgrade another widget, or press Finish to exit the application. In the event of an error, a message will be displayed. Please contact High End Systems support for further assistance; see *How to Report Problems to Support* (p.484).

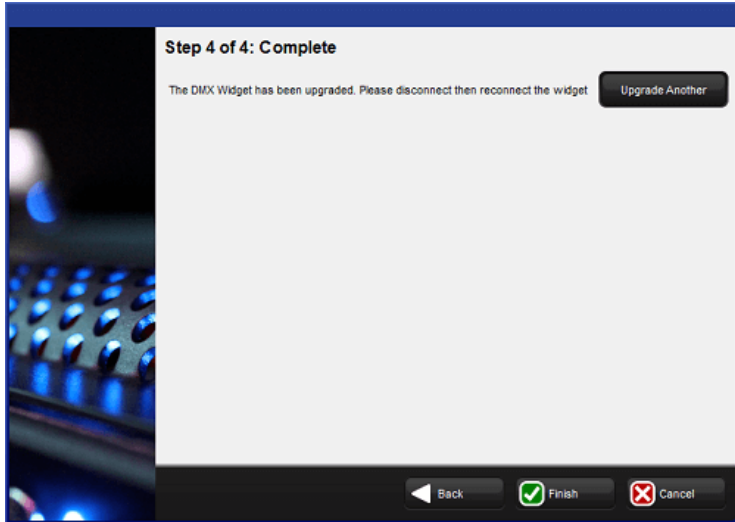

Section 30: Hog 4 PC

30.1 Software Installation

Hog 4 PC is a free software program that runs Hog 4 OS on Windows based computers and can be used as an offline editor, backup server, or stand alone controller.

Hog 4 PC system requirements:

- Operating System: Windows 10 (32-bit or 64-bit)
- Processor: Dual Core 1.7Ghz or faster
- Memory: 2GB minimum
- Hard Drive: 5GB of free hard drive space

Since Hog 4 OS makes use of multiple processes communicating via TCP/IP sockets, some Windows computer configurations may prevent the Hog 4 PC processes from communicating with each other. Windows firewall, Windows Defender, and aftermarket software security products may block TCP/IP communications needed to run Hog 4 PC or some of its services. Please ensure that exceptions for the individual Hog 4 PC processes are enabled.

Not meeting the system requirements, a lack of an enabled network connection, or multiple active network connections, and/or firewall settings can all result in Hog 4 PC communication failures. These communication failures typically cause the Splash Screen to repeatedly display 'Scanning port 6600' in its status window or other system errors when launching Hog 4 PC.

To install Hog 4 PC:

1. Download the installer for the latest version of Hog 4 PC from the High End Systems website. Once downloaded the file name will be Hog4PC_X-X-X-X.msi where the Xs represented the software version number.
2. Double click on the Hog 4 PC installer file to launch the install wizard.
3. The installer will quickly examine the Operating System and disk space. Click Next to continue.

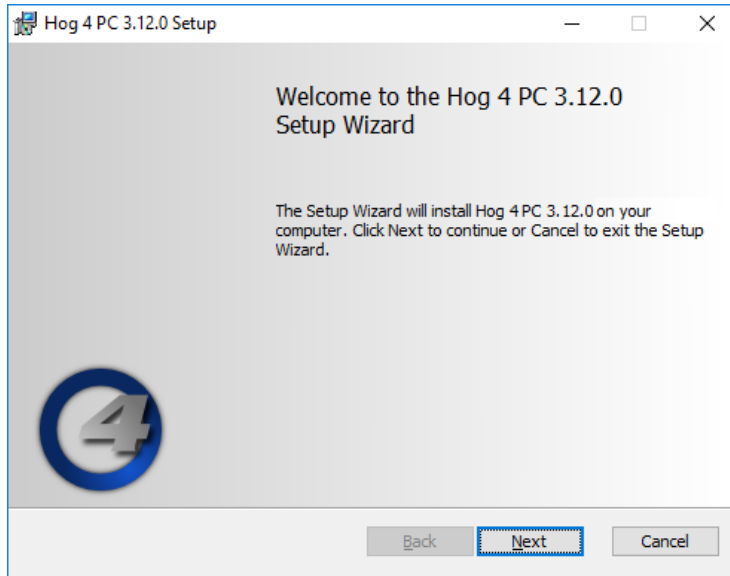

4. A setup screen will appear containing the Hog 4 PC End User License Agreement. Click the check-box to agree to the license terms and condition and then click Install.

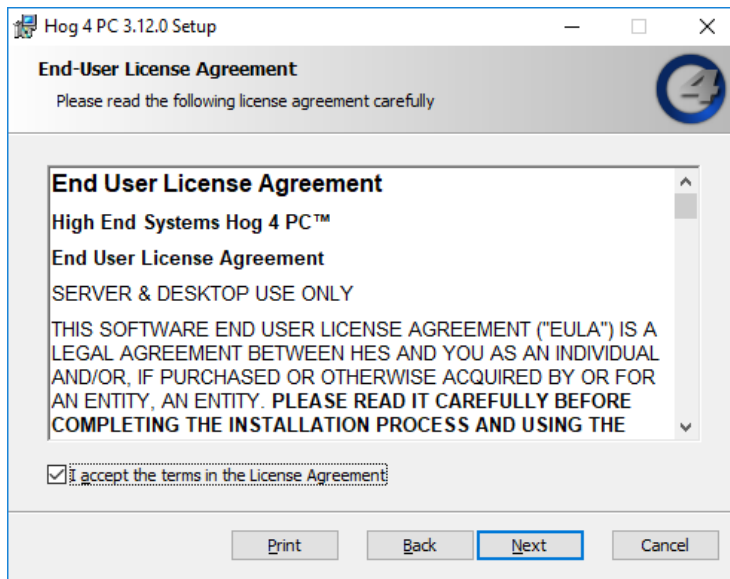

5. This prompts a screen with instructions for beginning or cancelling the installation. Click Install to begin installing.

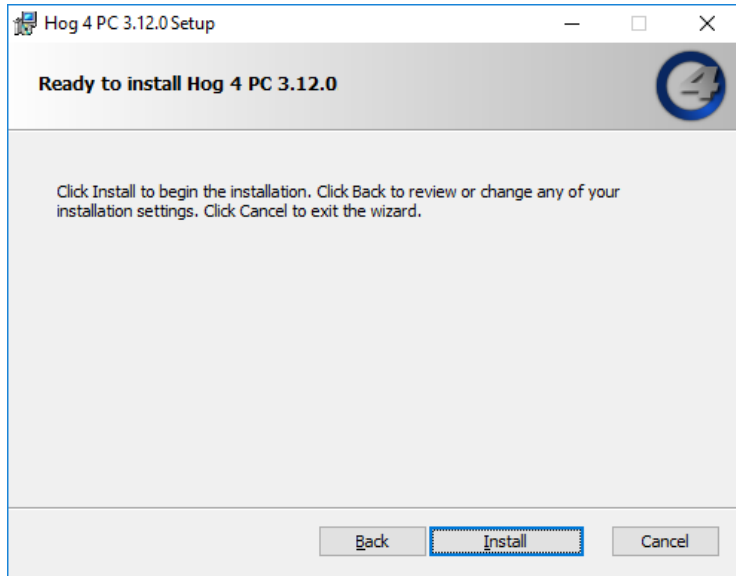

6. The installer will now proceed to copy several files onto the computer including a full fixture library. This can take several minutes depending on the computer's hardware.

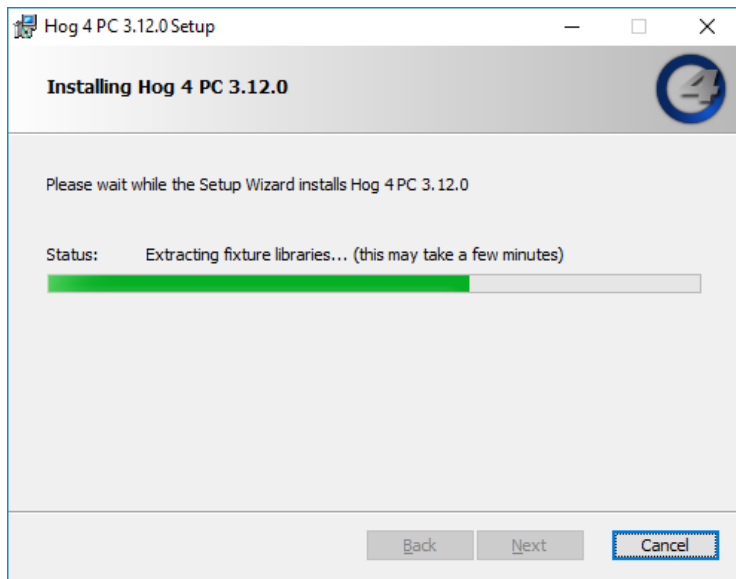

7. When the installation is complete a confirmation screen will appear. If software for the ETCnomad key was not detected during install then

an additional option to install ETCnomad Key software will appear. High End Systems recommends checking this option if presented. Click Finish.

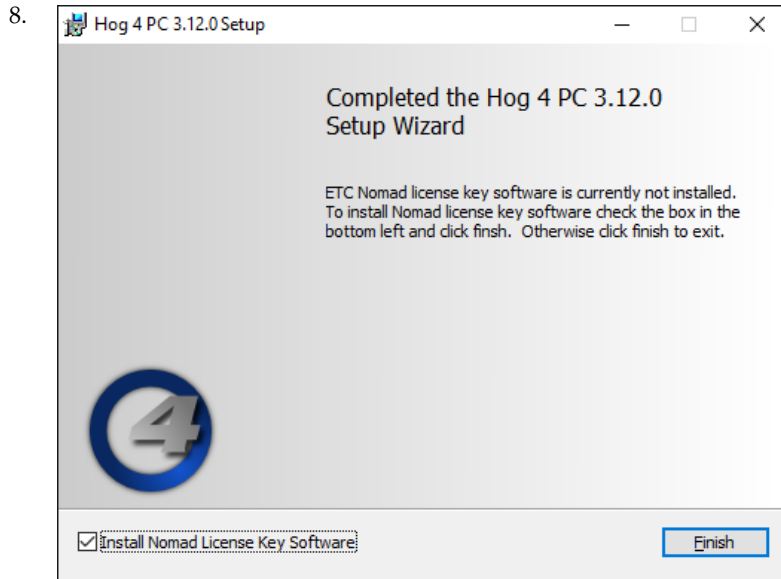

If the option to install ETCnomad Key software was selected in step 7 then please wait approximately 1 minute after clicking **Finish** before starting Hog 4 PC or restarting the computer.

30.2 Software Removal

To remove the Hog 4 PC application from your computer:

1. Launch "Apps and Features" in Windows 10. The easiest way to do this is to press the Windows key on your keyboard, type the word "apps", and then press enter.
2. Click on Hog 4 PC in the list of installed programs and then click Uninstall.

- **Lock Front Panel Position:** toggles the ability to move the Hog 4 PC Front Panel on the Windows desktop.
- **Toggle Front Panel:** toggles the Front Panel on/off.
- **Show All:** restores all Hog 4 PC screens to their previous size.
- **Minimize:** minimizes the current Hog 4 PC screen.
- **Minimize All:** minimizes all Hog 4 PC screens.
- **Maximize:** maximizes the current Hog 4 PC screen and hides the title bar.
- **Quit:** displays the exit dialog for the Hog 4 PC application.

Displaying Four Hog 4 PC Windows

By default, only two Hog 4 PC windows are shown. However, the Hog 4 PC software supports the display of three or four windows if desired. To open these windows:

1. Setup → Control Panel → Displays : open the Displays pane of the Control Panel; see *Figure 30.1, “The Displays pane of the Control Panel”*.
2. Set the resolutions for External Monitor 1 and External Monitor 2 (which correspond to the two external displays on the Hog 4 console).
3. Select OK.

Note that the control panel settings are system specific, so the number of screens will be retained regardless of the show file that is launched.

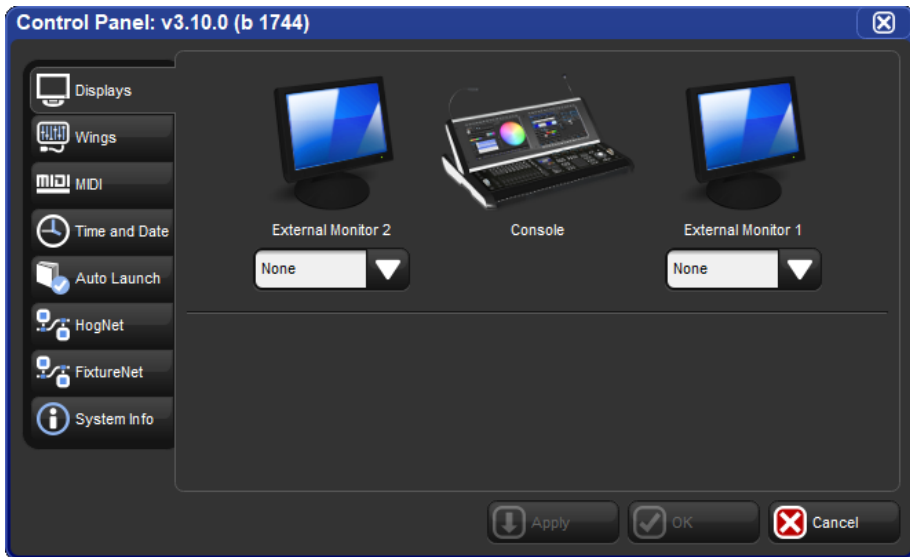

Figure 30.1. The Displays pane of the Control Panel

Section 31: Cheat Sheets

31.1 QWERTY Keyboard Shortcuts

Many functions of Hog 4 OS's can be executed using a standard QWERTY keyboard. To enable keyboard shortcuts press the Pause/Break key or Control + Q on the keyboard until MAP is shown as the keyboard mode on the Command Line Toolbar; see *Figure 31.1, "Keyboard Status in the Command Line Toolbar"*. Hog 4 OS disables the keyboard shortcuts (MAP mode) when text entry is expected (for example, after pressing Set or double clicking in a cell). When a text entry session is completed, MAP mode is automatically re-enabled if it was previously enabled.

When keyboard shortcuts are disabled, only the shortcut mapped to the Set key remains functional to allow quick labeling from the external keyboard.



Figure 31.1. Keyboard Status in the Command Line Toolbar

The following table contains a list of Hog 4 OS functions and their respective US keyboard mappings:

Function	Keystroke	Function	Keystroke
Toggle Shortcuts	CTRL + Q	Main GO	} or Space
Pig	CTRL	Main Pause	{
Open	ESC or O	Skip Fwd	K
Set	INSERT or i	Skip Back	J
Intensity	F11	Goto	G
Position	F2	Release	Z
Colour	F3	Pig + Release	ALT + Z
Beam	F4	Assert	A
Effects	F7	Next Page	: or ;
Macro	F5	@	' or @
Group	F1	Full	~ or #
Fixture	F12	Thru	*, > or X
Scene	F9	Minus (-)	- or _
Cue	F10	Plus (+)	= or +
List	F8	slash (/)	/ or ?
Page	F6	Point (.)	. or >
Record	R	Choose Master 1-10	ALT + 1 - 0
Merge	E	GO Master 1-10	TAB + 1 - 0
Move	M	Pause Master 1-10	Backspace + 1-0
Copy	P	Undo	CTRL + Z
Delete	D or Delete	Redo	CTRL + Y
Update	U	Visual Cut	CTRL + X
Live	V	Visual Copy	CTRL + C
Time	T	Visual Paste	CTRL + V
Setup	S	Visual Select Range	CTRL + cursors
Control	L	Backspace	Backspace
Fan	F	Enter	Enter
Highlight	H	GM	\
Blind	B	Central Choose	ALT + -
Clear	C	Bottom Right toolbar	TAB + F1-12
Next	N	Top Right toolbar	ALT + F1-12
Back	Y		

31.2 Hog 4 OS Key Combinations

Several of the functions of the Hog 4 OS can be accessed through use of the front panel key combinations and onscreen button combinations found in the tables below.

Programming/Patching	
Pig + Blind	Fades Changes when blinding and un-blinding
Pig + Clear	Undo
Pig + Flip	Sends fixture selection through possible flip positions in reverse order
Pig + Park	Un-parks selected fixtures, rather than parking them
Pig + Touch	Touches specified parameters and fixtures but as record ineligible
Pig + parameter wheels	Allows fine adjustment of the wheel's value
Pig + Record	inverts the current kind masking scheme for that record operation
Pig + Merge	inverts the current kind masking scheme for that merge operation
Pig + Fixture	Tokens the word "plot" on the command line
+ + any encoder wheel	Sets wheel to maximum value when encoder turned clockwise or minimum value when encoder turned counter-clockwise
- + any encoder wheel	Inverts wheel between positive and negative values when available (ex: gobo rotation)
backspace + encoder wheel	knocks out the coordinating parameter value for selected fixtures in the current active editor
. + any encoder wheel	Sets wheel to default value
Pig + . + any encoder wheel	Sets wheel to default value and mode
. + any kind button	Sets all parameters of that kind to their default values
Open + Fixture	Opens the fixture window.
Pig + @	When patching with View by DP enabled, un-patches the selected fixtures
Pig + I-Wheel	Increases/decreases intensities in proportion to their individual level. For example, if fixture 1 is at 10%, 2 at 50% and the wheel is increased by 10%, then fixture 1 will move to 11% and 2 will move to 55%

Window Control

Pig + Open + Colour	Opens the Colour Picker window
Pig + Open + Beam	Opens the Media Picker window
Pig + Open + Fixture	Opens the Plots directory
Open + backspace	Closes active window
Open + Thru	Cycles through open windows (change focus)
Open + Full	Maximizes active window
Open + @	Moves active window to next screen
Open + /	Copies and splits active window
Open + +	Sizes active window clockwise
Open + -	Sizes active window counter-clockwise
Pig + Size (on Window Control Toolbar)	Cycles through the possible window sizes in the reverse order
Open + 1-9	Opens view 1-9
Open + 0	Opens view 10
Pig + Next (on the View Toolbar)	Changes view toolbar to previous page of views, rather than next page of views
Open + first encoder wheel	Vertical Window Scroll (up/down)
Open + second encoder wheel	Horizontal Window Scroll (left/right)
Open + third encoder wheel	Zoom (plot window only)

Spreadsheets

Pig + Set	Acts as a right mouse click
Pig + arrow keys	Allows for selection of multiple cell items in spreadsheets
Pig + Backspace	Removes values from the currently highlighted cells in the Programmer or editor
Pig + Copy	Copies the contents of the currently selected cells
Pig + Move	Pastes into the currently selected cells

Directories

Pig + Set	Acts as a right mouse click
Pig + arrow keys	Extends directory item selection
Pig + button in a directory	Overrides directory Guard button

File Browser

Pig + Set	Acts as a right mouse click
Pig + click on file	Allows for selection of multiple files (Pig key is acting like control key)

Playback	
Pig + Release	Releases all active cuelists and scenes
List + Release	Releases any active cuelists NOT attached to masters on the current page
Scene + Release	Releases any active scenes NOT attached to masters on the current page
Pig + Main Play	Plays all cuelists and scenes attached to masters on the current page
Pig + Main Pause	Pauses all cuelists and scenes attached to masters on the current page
Holding choose key	Allows for the adjustment of that master's playback rate, effect rate, and effect size, and intensity using the main encoder wheels

Console Debug	
Pig + Open + Backspace	Opens the Launched Processes window
Pig + Open + 1	Opens the Log Viewer window
Pig + Open + 5	Opens the debug toolbar
Pig + Open + Delete	Restarts the console if held for 5 seconds. On Hog 4-18 holding this key combination for 5 seconds shuts down the console, then the keys must be released and held again for 5 seconds to boot the console back to the start screen.

Misc	
Pig + Enter	Toggles the function keys between Kind Key and Command Key mode
Pig + Setup	Toggles the worklight on and off
Pig + Undo	Redo
Pig + text with on-screen keyboard	Acts as a shift key, to type upper case characters
Setup + first encoder wheel button	Calibrate touchscreens; quit calibration by pressing enter key
Setup + encoder wheel	Adjustment for brightness of LCD backlights, LEDs on front panel keys, desklights, and worklight
Pig + .	Toggles slot toolbar and encoder wheel toolbar on/off
Pig + 0, 1, 2, 3, etc.	Toggles playback bars on/off

31.3 DMX Processor 8000 Front Panel Button Combinations

The keys on the front panel of the DMX Processor 8000 are used for standard menu navigation. However as the unit boots you can view specific boot information via a scroll bar. Once the DMX Processor 8000 is fully booted, it displays the standard menu. In addition the following reset options are available:

Hard Reset: to force a hard reset of the DMX Processor 8000, hold the middle and bottom buttons for four seconds (use the center and right buttons for older DP8000 units where the front panel buttons are laid out horizontally). Once the reset begins you will see I/O Board Disconnected on the display.

DMX Board Firmware Reload: to reload the DMX board firmware from the Processor's front panel, hold down any single button the DP8000 front panel as the unit is powered on. Once the process begins you will see the DP8000 Bootloader message on the display. After about one minute the firmware will be reloaded.

CPU Board Firmware Reload and Restore to Defaults: to reload the CPU board firmware hold down all three buttons on the front of the DP8000 as the unit is powered on. The DMX Processor 8000 will then reload its firmware from the network. Once the process begins you will see the Forcing Software Reload message on the display.

31.4 Front Panel Diagrams

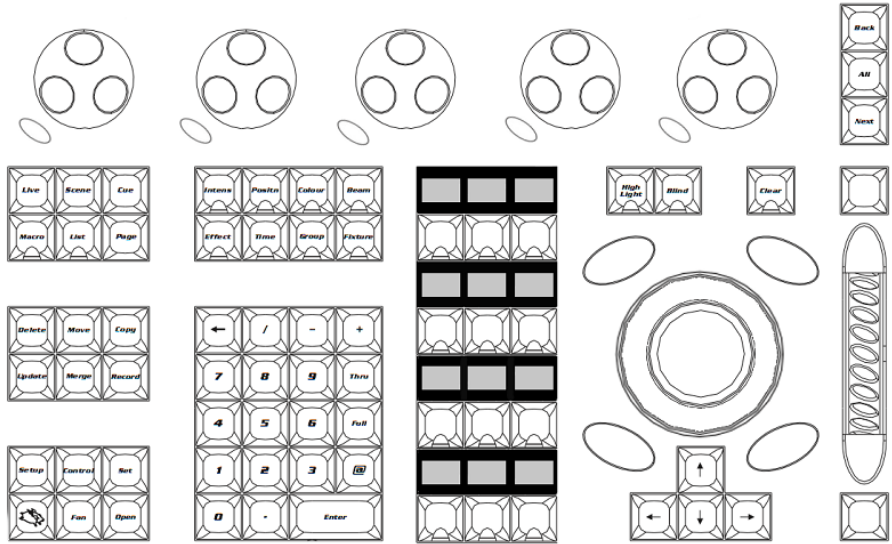

Figure 31.2. Programmer section of the Hog 4 and Hog 4-18 front panel

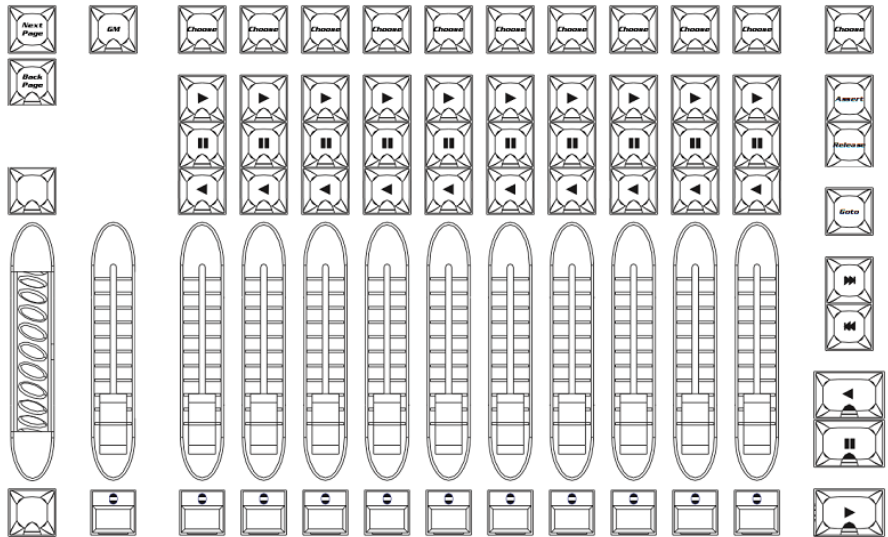

Figure 31.3. Playback section of the Hog 4 front panel

31.5 Decimal to Hex Conversion Chart

Dec	Hex	Dec	Hex	Dec	Hex	Dec	Hex	Dec	Hex	Dec	Hex	Dec	Hex	Dec	Hex
0	0	16	10	32	20	48	30	64	40	80	50	96	60	112	70
1	1	17	11	33	21	49	31	65	41	81	51	97	61	113	71
2	2	18	12	34	22	50	32	66	42	82	52	98	62	114	72
3	3	19	13	35	23	51	33	67	43	83	53	99	63	115	73
4	4	20	14	36	24	52	34	68	44	84	54	100	64	116	74
5	5	21	15	37	25	53	35	69	45	85	55	101	65	117	75
6	6	22	16	38	26	54	36	70	46	86	56	102	66	118	76
7	7	23	17	39	27	55	37	71	47	87	57	103	67	119	77
8	8	24	18	40	28	56	38	72	48	88	58	104	68	120	78
9	9	25	19	41	29	57	39	73	49	89	59	105	69	121	79
10	A	26	1A	42	2A	58	3A	74	4A	90	5A	106	6A	122	7A
11	B	27	1B	43	2B	59	3B	75	4B	91	5B	107	6B	123	7B
12	C	28	1C	44	2C	60	3C	76	4C	92	5C	108	6C	124	7C
13	D	29	1D	45	2D	61	3D	77	4D	93	5D	109	6D	125	7D
14	E	30	1E	46	2E	62	3E	78	4E	94	5E	110	6E	126	7E
15	F	31	1F	47	2F	63	3F	79	4F	95	5F	111	6F	127	7F

Section 32: Troubleshooting

32.1 Console won't startup

- If a software update has failed the console can get into a state where it either fails to start properly, or it goes immediately to the shutdown screen. A full re-install will be necessary; see *Console Software Full Install* (p.452).
-

32.2 No DMX Output from Console's built-in DMX Outputs

1. Open the control panel (setup, control panel) and select the system info tab. Ensure the serial number of the internal DMX Widget is being reported. (For HedgeHog 4 consoles two DMX Widgets should be reported). If the widget serial is listed then move to step 2 and continue troubleshooting. If it is listed as "not found" then most likely the widget's power and/or USB cable has been disconnected. Access the inside of the console and confirm the widget has power and a good USB connection to the motherboard.
2. Open the network window (setup, network) and make sure the internal DP8000 is reporting "Outputs Active". If the internal DP8000 is reported as "offline" then log off the show and click on the settings button in the start window. Ensure that "run internal DP" is turned on and set to the appropriate net number. Log back onto the show and check output again. If console is still not outputting DMX then proceed to step 3 and continue troubleshooting.
3. Double check the patch window and ensure that fixtures are patched to the correct DP and dmx universes. This sounds like a simple thing to check but in some cases output is failing only due to a bad patch. If the console is still not outputting dmx then proceed to step 4.
4. Open the network window (setup, network) and click on the DP8000 to which the fixtures are patched. Click on the settings button. In the settings window navigate to the "DMX Widgets" tab. Ensure that the console's built-in dmx widget outputs are listed and assigned in this window. If they are not assigned and you have confirmed all the steps in this troubleshooting section then perform a full re-install of the Hog 4 OS.
5. If a you have performed all the troubleshooting steps in this section and the problem continues to persist then please contact High End Systems technical support for further assistance.

32.3 No ArtNet Output from console's FixtureNet Port

1. Double check the patch window and ensure that your fixtures are patched to the correct DP and the correct dmx universes. This sounds like a simple thing to check but in some cases output is failing only due to a bad patch. If you are still not seeing ArtNet output from the console proceed to step 2.
2. Open the network window (setup, network) and make sure the internal DP8000 is reporting "Outputs Active". If the DP8000 is being reported as "offline" then log off the show and click on the settings button in the start window. Ensure that "run internal DP" is turned on and set to the appropriate net number. Log back onto the show and check output again. If console is still not outputting Art-Net the proceed to step 3 and continue troubleshooting.
3. Open the network window (setup, network) and click on the internal DP8000 to which the fixtures are patched. Click on the settings button. In the node settings window navigate to the "FixtureNet" tab. Ensure that the FixtureNet IP address and subnet are set appropriately for the network. Note: If you make any changes to the FixtureNet IP address or subnet, you must log off and log back onto the show for those new IP address settings to take effect.
4. Open the network window (setup, network) and click on the internal DP8000 to which the fixtures are patched. Click on the settings button. In the node settings window navigate to the "ArtNet" tab. Ensure that the ArtNet outputs are set correctly for both subnet and universe.
5. Connect a windows computer to the network and run a software application tool such as DMX Workshop. These kinds of software applications allow you to see ArtNet streams on the network and can be used to further help in detecting where the problems might be occurring.
6. If you have performed all the troubleshooting steps in this section and the problem continues to persist then please contact High End Stems technical support for further assistance.

32.4 The console appears to have crashed or frozen

Hog 4 OS runs as a series of separate ‘processes’ that can start and stop individually. Often, when the console appears to have crashed or frozen, it is only one process that is causing the problem, while the rest of the processes are still running normally. In particular, an editor or the desktop may crash, while playback continues normally. Before restarting the entire console, therefore, you should see if the problem can be cured by restarting the individual process:

1. Pig + Open + Backspace : open the Launched Processes window.
2. Kill processes that are not responding by right clicking on them and selecting Kill.
3. Restart the process by right clicking and selecting Restart. An exception is the Editor process which will disappear when killed; you can restart it by re-opening the Programmer or an editor window.

32.5 Console isn't talking to DMX Processors

1. Check that the display on the DMX Processor shows ‘Outputs Active’. If it does not, then see if it is in the process of getting the show data or connecting, or crashed. If it has crashed, restart it by disconnecting the mains power, waiting a few moments, and reconnecting it.
2. Check the network cabling. The Link light will be lit on the DMX Processor if the correct connection has been made.
3. Check the network settings. The DMX Processor and console both need to be on the same subnet.
4. Check the **port number** setting. The DMX Processor and console both need to have the same Port Number. See *HogNet Network* (p.63).
5. Check the software. The DMX Processor and console both need to be running the same version of the software; see *DMX Processor Software Update* (p.456).

32.6 Playback controls don't behave as expected

- Check that the playback controls haven't been mapped to different functions to their normal ones. See *Configuring Physical Master Playback Controls* (p.290).

32.7 ETCnomad Key not recognized by Hog 4 PC

Components needed to run the license key were either not installed or are currently missing from Windows. Try manually reinstalling the ETCnomad License key drivers by following these steps:

1. Press **⊞ Windows Key + R** on the computer's keyboard. This opens a "run" dialogue box.
 2. In the run dialogue box type: **C:\Program Files (x86)\High End Systems\Hog 4 PC\haspdinst.exe -i** and then press enter.
 3. A small installer window will appear. When the installer is complete a confirmation dialogue will appear. Click ok.
 4. The ETCnomad License key should now operate as expected.
-

32.8 The Front Panel Reboots Unexpectedly

Care should be taken when transmitting a personal radio while in close proximity to a console front panel. Always keep radio transmitting devices at least eight inches from the console surface.

In the event of a radio transmitting within close proximity of the console, the front panel firmware may reboot causing a temporary loss of control of the keys and hardware for approximately 20 seconds. During this time the desk lights may dim as well. After 20 seconds the front panel will reboot and normal functionality will be restored. If the problems persist, move the radio transmitting device further from the console.

32.9 How to Report Problems to Support

When reporting problems with the console (known as "bugs") it is important that the information you provide is as clear and detailed as possible to ensure that the problem can be fixed.

Please follow the guidelines below.

Please report bugs to:

support@highend.com

24/7 phone support: +1-512-836-2242

http://forums.highend.com

32.9.1 Reporting Problems with the Console

Please include the following information in your bug report:

1. The piece of hardware that exhibited the problem, including the version number of the software being used.
2. The actions taken that induce the problem in the first place, including whether the problem is repeatable using the same actions.
3. The symptoms of the problem.
4. The network configuration of system.
 - The type and number of Hog console systems in use
 - How many DMX Processors and MIDI/Timecode Processors.
 - What sort of routers/hubs are being used.
 - Other PC's or applications (such as ArtNet, ETCNet, Web Servers, and so on) that are sharing the same network.

Once a problem has been reported it will often be necessary for the support team at Flying Pig Systems to clarify some of the details and obtain additional information. Typically this ends up with a request for a copy of the show, so a backup of the show should be transferred to a PC where it can be mailed to support@highend.com.



Tip

The version number of the software installed on your console can be found on the System Info pane of the Control Panel window.

32.9.2 Reporting Problems with Hog 4 PC

In the event of a failure with Hog 4 PC, it is important to provide as much information as possible. Different computer configurations, other applications, and additional hardware may all have unexpected results. When reporting errors, please provide the following information:

- Name
- Date
- Hog 4 PC software version and build number
- Operating system
- Computer specifications
- Number of displays
- Connected USB devices

- Networked devices
- Other running applications
- Detailed description of the problem including instructions to reproduce (if possible) and the exact syntax used
- List of any errors reported by the software

If Hog 4 PC crashes or fails, it will output a .dmp file in the application directory, for example 'C:\Program Files\Flying Pig Systems\Hog4PC' (if you accepted the default location when you installed Hog 4 PC). Please send this .dmp file along with your bug report to support@highend.com.

32.9.3 Reporting Problems with the User Manual

Please include the following information in your bug report:

1. The nature of the problem:
 - Missing information.
 - Incorrect information.
 - Unclear or ambiguous information.
 - Unable to find information in the index.
2. The section number where the problem is.
3. The version number of the manual. In printed and PDF editions, you can find this on the title page at the start of the manual. The on-line help within the console shows the version on the main contents page; you can go to this page by clicking 'home' at the bottom of any page.

32.9.4 About Software Version Numbering

The software version number is made up of four parts: the major version number, the minor version number, the current release number, and the build number. For example:

v1.2.3 b512 : 1 is the major number, 2 is the minor version number, 3 is the current release, and 512 is the build.

Section 33: Service

33.1 Replacing the Screens



Caution

Always shut down and disconnect the mains power before removing the front panel.

Damaged screens are easily replaced:

1. With the LCD box in the horizontal (flat) position undo the six screws surrounding the screen using a 3mm allen key.
2. Carefully remove the front metal work and Soft Key strips (soft key strips are on Hog 4 Console Only).
3. With the LCD box in the vertical (upright) position undo the eight screws on the back panel of the screen assembly using a 3mm allen key. Remove the back panel metal work. (This entire step for Hog 4 Console Only)
4. With the back panel removed carefully remove the eight screws on the back of the LCD assembly using a 3mm allen key. Make sure you have somebody hold the screens from the front of the console while you do this. (This entire step is for Hog 4 Console Only)
5. Lift the screens from the console and unplug the cables from behind.
6. Replace with a new screen assembly by performing previous steps in reverse.

33.2 Replacing Faders

This section covers how to replace the faders on Hog 4, Full Boar 4, Playback Wing 4, Road Hog 4, and Nano Hog 4.

NOTE: Faders cannot be replaced on the HedgeHog 4 console as they are soldered to the mainboard.



Caution

Always shut down and disconnect the mains power before removing the front panel.

33.2.1 Replacing faders on Hog 4, Full Boar 4, and Playback Wing 4

1. Pull off the fader handles for the fader that you wish to replace.
2. Undo the four front panel screws with a 3mm allen key (plus the two thumb screws in the armrest on the Hog 4 console) , and carefully lift off the front panel from the edge closest to you.
3. Gently unplug the fader's cable lead from the main board.
4. Unscrew the fader's two front panel screws from the top side of the front panel using a 2mm allen key and remove the fader.
5. Fit the new fader in place ensuring that it sits completely flat against the PCB.
6. Connect the new fader's cable led to the main board.
7. To re-assemble follow disassembly steps in reverse order.

33.2.2 Replacing faders on Road Hog 4 and Nano Hog 4

1. Remove each of the 10 fader handles from the front panel of the console.
2. Loosen the setscrews inside each of the four encoder wheels using a 5/64" allen key and gently remove each of the four encoder wheels.
3. Remove the four front panel screws with a 3mm allen key (if on a Nano Hog 4 4, also remove the additional two screws on the back of the front panel), and carefully lift off the front panel from the edge closest to you.
4. Remove the 16 hex-head crosshead screws from the backside of the front panel (if on a Nano Hog 4, 15 hex-head crosshead screws) using either a P2 crosshead screwdriver or a (6.5 mm) nut driver.
5. Remove the 4 small crosshead screws with a P1 crosshead screwdriver.
6. Identity which fader you wish to remove and gently unplug it's cable lead from the main board.
7. Press the black plastic clips on the fader from the backside of the main board.
8. Remove desired fader.
9. Replace fader and re-assemble the console by following the disassembly steps in reverse order.

33.3 Cleaning Faders

Faders are often unnecessarily discarded when all they need is a cleaning. This section will cover how to clean the faders on all of the consoles in the Hog 4 family.

33.3.1 **Cleaning faders on Hog 4, Full Boar 4, and Playback Wing 4**

1. Remove the dirty fader. See *Replacing Faders* (p.487).
2. Wipe the tracks with a dry, clean tissue. Do *not* use solvents.
3. Replace the cleaned fader. See *Replacing Faders* (p.487).

33.3.2 **Cleaning faders on Road Hog 4 and Nano Hog 4**

1. Remove each of the 10 fader handles from the console.
2. Loosen the setscrews inside each of the four encoder wheels using a 5/64" allen key and gently remove each of the four encoder wheels.
3. Remove the four front panel screws with a 3mm allen key (if on a Nano Hog 4 4, also remove the additional two screws on the back of the front panel), and carefully lift off the front panel from the edge closest to you.
4. Remove the 16 hex-head crosshead screws on the backside of the front panel (if on a Nano Hog 4, 15 hex-head crosshead screws) with either a P2 crosshead screwdriver or a (6.5mm) nut driver.
5. Remove the 4 small crosshead head screws with a P1 crosshead screwdriver.
6. Wipe the tracks with a dry, clean tissue. Do *not* use solvents.
7. Re-assemble the console by following the disassembly steps in reverse order.

33.3.3 **Cleaning faders on HedgeHog 4**

1. Remove each of the 10 fader handles from the console.
2. Remove the 10 front panel screws with a 3mm allen key and carefully lift off the front panel from the edge closest to you.
3. Unplug the ribbon cable that connects the left main board to the right mainboard.
4. Remove the 12 hex-head crosshead screws on the backside of the left mainboard with either a P2 crosshead screwdriver or a (6.5mm) nut driver.
5. Wipe the tracks with a dry, clean tissue. Do *not* use solvents.
6. Re-assemble the console by following the disassembly steps in reverse order.

33.4 Replacing the Trackball

**Caution**

Always shut down and disconnect the mains power before removing the front panel.

To replace the Trackball on a Hog 4 or Full Boar 4 console:

1. Undo the four front panel screws with a 3mm allen key (plus the two thumb screws in the armrest on the Hog 4 console) , and carefully lift up the front panel from the edge closest to you and insert into service slot.
2. Look underneath the front panel and locate the cable connection that connects the Trackball to the PCB. Unplug this connection.
3. Unscrew the 3 allen screws that hold the Trackball to the front panel (use a 3mm allen key). You should now be able to remove the trackball from the console.
4. Replace with a new trackball assembly and reassemble your console by performing this procedure in reverse.

Section 34: Safety Information

34.1 Safety Warnings

34.1.1 For Continued Protection Against Fire

- Only connect this equipment to a branch circuit having a maximum overload protection of 20 A.

34.1.2 For Continued Protection Against Electric Shock

1. If this equipment was received without a line cord plug, attach the appropriate line cord plug according to the following code:
 - brown - live
 - blue - neutral
 - green/yellow - earth
2. As the colours of the cores in the mains lead of this equipment may not correspond with the coloured markings identifying the terminals in your plug, proceed as follows:
 - the core which is coloured green and yellow must be connected to the terminal in the plug which is marked with the letter E or by the earth symbol \oplus , or coloured green or green and yellow.
 - the core which is coloured blue must be connected to the terminal which is marked with the letter N or coloured black.
 - the core which is coloured brown must be connected to the terminal which is marked with the letter L or coloured red.
3. Class I equipment. This equipment must be earthed.
4. Equipment suitable for dry locations only. Do not expose this equipment to rain or moisture.
5. Disconnect power before servicing.
6. Refer servicing to qualified personnel; no user serviceable parts inside.

34.2 Informations Importantes Sur La Sécurité

34.2.1 Pour Une Protection Permanente Contre Les Incendies

- Cet appareil comporte une protection de 20 A contre les surcharges électrique.

34.2.2 Pour Une Protection Permanente Contre Les Chocs Électriques

1. Si cet équipement est livré sans prise sur le câble d'alimentation, veuillez connecter la prise de courant selon le code suivant:
 - marron - phase
 - bleu - neutre
 - vert/jaune - terre
2. Débrancher le courant avant d'effectuer des réparations.
3. Cet équipement doit être uniquement utilisé dans des endroits secs. Ne pas l'exposer à la pluie ou l'humidité.
4. À l'intérieur de l'équipement il n'y a pas de pièces remplaçables par l'utilisateur. Confiez l'entretien à un personnel qualifié.
5. Equipement de Classe I. Cet équipement doit être mis à la terre.

34.3 Wichtige Hinweise Für Ihre Sicherheit

34.3.1 Zum Schutz Vor Brandgefahr

- Dieses Gerät darf nur an eine Zweigleitung mit einem Überlastungsschutz von höchstens 20 A angeschlossen werden.

34.3.2 Zum Schutz Gegen Gefährliche Körperströme

1. Wenn dieses Gerät ohne einen Netzkabelstecker erhalten wurde, ist der entsprechende Netzkabelstecker entsprechend dem folgenden Code anzubringen:
 - Braun - Unter Spannung stehend
 - Blau - Neutral
 - Grün/Gelb - Erde

2. Da die Farben der Leitungen im Hauptanschluss möglicherweise nicht mit den farbigen Markierungen die die Anschlussklemmen identifizieren übereinstimmen, fahren sie wie folgt fort:
 - Die Grün und Gelb gefärbte Leitung muss im Stecker mit der mit dem Buchstaben E oder dem Erde Symbol markierten ⊕, oder der Grün und Gelb gefärbten Anschlussklemme verbunden werden.
 - Die blau gefärbte Leitung muss mit der mit dem Buchstaben N oder der Schwarz gefärbten Anschlussklemme verbunden werden.
 - Die Braun gefärbte Leitung muss mit der mit dem Buchstaben L markierten oder rot gefärbten Anschlussklemme verbunden werden.
3. Dieses Gerät gehört zur Klasse I. Dieses Gerät muß geerdet werden.
4. Diese Geräte sind nur zum Einbau in trockenen Lagen bestimmt und müssen vor Regen und Feuchtigkeit geschützt werden.
5. Vor Wartungsarbeiten stets den Netzstecker ziehen.
6. Servicearbeiten sollten nur von Fachpersonal ausgeführt werden. Das Gerät enthält keine wartungsbedürftigen Teile.

34.4 Información Importante De Seguridad

34.4.1 Para Protección Continua Contra Incendios

- Este equipo debe conectarse a un circuito que tenga una protección máxima contra las sobrecargas de 20 A.

34.4.2 Para La Protección Continua Contra Electrocuciones

1. Si se recibió este equipo sin el enchufe de alimentación, monte usted el enchufe correcto según el clave siguiente:
 - moreno - vivo
 - azul - neutral
 - verde/amarillo - tierra
2. Desconecte el suministro de energía antes de prestar servicio de reparación.

3. Este equipo se adecua a lugares secos solamente. no lo exponga a la lluvia o humedad.
4. Derive el servicio de reparación de este equipo al personal calificado. El interior no contiene repuestos que puedan ser reparados por el usuario.
5. Equipo de Clase I. Este equipo debe conectarse a la tierra.

34.5 **Importanti Informazioni Di Sicurezza**

34.5.1 **Per Prevenire Incendi**

- Questa apparecchiatura e' da collegarsi ad un circuito con una protezione da sovraccarico massima di 20 amperes.

34.5.2 **Per Prevenire Le Scosse Elettriche**

1. Se questa apparecchiatura è stata consegnata senza una spina del cavo di alimentazione, collegare la spina appropriata del cavo di alimentazione in base ai seguenti codici:
 - marrone - sotto tensione
 - blu - neutro
 - verde/giallo - terra
2. Disinnestare la corrente prima di eseguire qualsiasi riparazione.
3. Questa apparecchiatura e' da usarsi in ambienti secchi. Non e' da essere esposta ne alla pioggia ne all' umidita'.
4. Per qualsiasi riparazione rivolgersi al personale specializzato. L' utente non deve riparare nessuna parte dentro l' unita'.
5. Aparecchio di Classe I. Questa apparecchiatura deve essere messa a terra.

34.6 **Vigtig Sikkerhedsinformation**

Advarsel: Beskyttelse mod elektrisk chock.

VIGTIGT! LEDEREN MED GUL/GROEN ISOLATION MAA KUN TILSLUTTES KLEMME MAERKET ⊕ ELLER ⊖.

34.7 安全に関する情報

34.7.1 警告: 火災からの継続的な保護の為に

- この装置には分岐回線への接続の為に最大 20 A の過負荷防止機構を持っています。

34.7.2 警告: 感電に対する継続的な保護の為に

1. プラグの付いていない状態でこの装置を受け取った場合は、以下のコード表にしたがって、適切にプラグを取り付けて下さい。:
 - Brown (茶色) - Live (ライブ)
 - Blue (青) - Neutral (ニュートラル)
 - Green/Yellow (緑/黄色) - Earth (アース)
2. ここで説明されている各部品に関する色があなたの持っているプラグの末端の色と対応していない場合があります。以下にしたがって接続して下さい。:
 - Green/Yellow (緑/黄色) のケーブルを、プラグの末端に E もしくは アースのシンボル ⊕ の表記のある物に接続するか、Green/Yellow (緑/黄色) の物に接続して下さい。
 - Blue (青) のケーブルを、プラグの末端に N が表記された物もしくは 黒に塗られた物に接続して下さい。
 - Brown (茶色) のケーブルを、プラグの末端に L が表記された物もしくは 赤に塗られた物に接続して下さい。
3. この装置は Class I 機器です。この為この装置はアースしなければなりません。
4. この装置は乾燥した状態でのみ使用出来ます。この装置を雨又は湿気にさらさないで下さい。
5. 修理点検を行う場合は事前に電源を切り離して下さい。
6. 整備点検の項目は資格を持った技師の為に物です。; ユーザーによって修理点検を行えるパーツは存在していません。

Section 35: Technical Specifications

35.1 Hog 4 Console

35.1.1 Input and Output Connections

Mains in:	V-Lock style locking IEC 320 connector (5A/250V rated cable supplied) 100-240 VAC, 3.2-2A, 50-60 Hz 1 x 5x20mm 5A T fuse
MIDI in,out,thru:	Musical Instrument Digital Interface input, output, and thru ports
LTC In:	3-pin XLR Linear Timecode Input
DVI out:	3 x DVI-I single link female connectors
Ethernet:	2 x Neutrik Ethercon; Gigabit Ethernet port
USB:	Universal Serial Bus 2.0 ports (6 rear, 1 inside front utility tray, 1 inside armrest)
DMX out:	8 x Neutrik 5 pin female XLR Galvanized Isolated
Keyboard:	Built-in Miniature QWERTY keyboard

35.1.2 Power, Weight and Dimensions

Power:	300W
Weight:	75 lbs (34 kg)
Dimensions with Screen Down:	40.5" (1028.7mm) wide 28.49" (723.7mm) deep 6.49" (164.75mm) high
Dimensions with Screen Up:	40.5" (1028.7mm) wide 28.49" (723.7mm) deep 16.43" (417.39mm) high

35.2 Hog 4-18 Console

35.2.1 Input and Output Connections

Mains in:	V-Lock style locking IEC 320 connector (5A/250V rated cable supplied) 100-240 VAC, 3.2-2A, 50-60 Hz 1 x 5x20mm 5A T fuse
MIDI in,out,thru:	Musical Instrument Digital Interface input, output, and thru ports
LTC In:	3-pin XLR Linear Timecode Input
Ethernet:	2 x Gigabit Ethernet port
USB:	Universal Serial Bus 2.0 ports (6 rear, 2 inside front utility tray)
Video out:	3 x Display Port female connectors
DMX out:	8 x Neutrik 5 pin female XLR Galvanized Isolated
Keyboard:	Built-in Miniature QWERTY keyboard
Mounting:	2 x 5/8" spigot receivers

35.2.2 Power, Weight and Dimensions

Power:	120W Max
Weight:	92 lbs (42 kg)
Dimensions with Screen Down:	39.1" (994mm) wide 29.4" (746mm) deep 6.7" (169mm) high
Dimensions with Screen Up:	39.1" (994mm) wide 29.4" (746mm) deep 16.9" (430mm) high

35.3 Full Boar 4 Console

35.3.1 Input and Output Connections

Mains in:	IEC 320 connector (5A/250V rated cable supplied) 100-240V, 50/60Hz, 5A maximum
DVI out:	2 x 24 pin DVI-D single link female connectors
USB:	Universal Serial Bus 2.0 ports (4 rear) Universal Serial Bus 3.0 ports (1 top)
Ethernet:	2 x Neutrik Ethercon; Gigabit Ethernet port
LTC In:	3-pin XLR Linear Timecode Input
MIDI in,out,thru:	Musical Instrument Digital Interface input, output, and thru ports
DMX Out:	4 x Neutrik 5 pin female XLR
Keyboard:	Not included (Generic Class USB keyboards Supported)

35.3.2 Power, Weight and Dimensions

Power:	500W
Weight:	45 lbs (20.41 kg)
Dimensions:	35.49" (901.19mm) wide 22.65" (575.36mm) deep 9.62" (244.34mm) high

35.4 Road Hog 4 Console

35.4.1 Input and Output Connections

Mains in:	IEC 320 connector (5A/250V rated cable supplied) 100-240V, 50/60Hz, 5A maximum
Video out:	1 x DVI-D / 1 x VGA (only 1 can be used at a time)
USB:	3 x Universal Serial Bus 2.0 ports (2 rear, 1 front) 2 x Universal Serial Bus 3.0 ports (2 rear)
Ethernet:	2 x Gigabit base-TX Ethernet port
DMX out:	4 x Neutrik 5 pin female XLR
Keyboard:	Not included (Generic Class USB keyboards Supported)

35.4.2 Power, Weight and Dimensions

Power:	500W
Weight:	38.6 lbs (17.5 kg)
Dimensions:	26.7" (678.18mm) wide 27.61" (701.32mm) deep 8.10" (205.8mm) high

35.5 HedgeHog 4 Console

35.5.1 Input and Output Connections

Mains in:	IEC 320 connector (5A/250V rated cable supplied) 100-240V, 50/60Hz, 2.5 A maximum
USB:	2 x Universal Serial Bus 2.0 ports (rear)
Ethernet:	1 x Gigabit base-TX Ethernet port
DMX out:	2 x Neutrik 5 pin female XLR
Keyboard:	Not included (Generic Class USB keyboards Supported)

35.5.2 Power, Weight and Dimensions

Power:	250W
Weight:	17 lbs (7.7 kg)
Dimensions:	20.74" (526.8mm) wide 21.83" (554.37mm) deep 3.97" (100.78mm) high

35.6 HedgeHog 4 Console (Jan 2015 and later)

35.6.1 Input and Output Connections

Mains in:	IEC 320 connector (5A/250V rated cable supplied) 100-240V, 50/60Hz, 2.5 A maximum
Video Out:	1 x DVI-D / 1 x VGA (only 1 can be used at a time)
USB:	2 x Universal Serial Bus 2.0 ports (rear) 2 x Universal Serial Bus 3.0 ports (rear)
Ethernet:	2 x Gigabit base-TX Ethernet port
DMX out:	2 x Neutrik 5 pin female XLR
Keyboard:	Not included (Generic Class USB keyboards Supported)

35.6.2 Power, Weight and Dimensions

Power:	250W
Weight:	17 lbs (7.7 kg)
Dimensions:	20.74" (526.8mm) wide 21.83" (554.37mm) deep 3.97" (100.78mm) high

35.7 Nano Hog 4 Console

35.7.1 Input and Output Connections

Mains in:	External DC Power Supply (5.5A/12V) 100-240V, 50/60Hz, 1.5A maximum
USB:	Type B USB Input Socket Universal Serial Bus 2.0 ports (2 rear)
DMX Out:	4 x 5-pin XLR DMX Outputs (when DMX output kit is installed)

35.7.2 Power, Weight and Dimensions

Power:	5W
Weight:	18.1 lbs (8.21 kg)
Dimensions:	26.7" (678.18mm) wide 13.76" (349.52mm) deep 3.54" (89.85mm) high

35.8 **DMX Processor 8000**

35.8.1 **Input and Output Connections**

Mains in:	V-Lock style locking IEC 320 connector 100-240V, 50/60Hz, 4A maximum
DMX out:	Neutrik 5 pin female XLR Isolated, Half Duplex DMX512 outputs (x8)
Ethernet:	EtherCon Gigabit Ethernet port (x2)
Expansion:	USB-A 2.0 High Speed (x2)

35.8.2 **Power, Weight and Dimensions**

Power:	200W
Weight:	2.7Kg
Dimensions:	480mm wide 280mm deep 45mm high

35.9 Playback Wing 4

35.9.1 Input and Output Connections

Mains in:	Built-in Power Supply with IEC 320 connector 100-240V, 50/60Hz, 1.5A maximum
Digital video in:	DVI-D connector
USB:	Type B USB input socket USB-A 2.0 High Speed (x2)

35.9.2 Power, Weight and Dimensions

Power:	75W
Weight:	27.6 lbs (12.51 kg)
Dimensions:	20.14" (511.56mm) wide 24.02" (610.05mm) deep 9.62" (244.34mm) high

35.9.3 Performance

Display:	15.6" Diagonal active matrix TFT LCD
Native resolution:	1366 x 768
Input frequency:	31.5 - 80 kHz (H), 56-75 Hz (V)
Contrast ratio:	500:1 (typical)
Viewing angle:	160 x 160 degrees (typical)
Response:	80 ms (typical)
Brightness:	300 cd/m2 (typical)

35.10 Master Wing 4

35.10.1 Input and Output Connections

Mains in:	Built-in Power Supply with IEC 320 connector 100-240V, 50/60Hz, 1.5A maximum
Digital video in:	DVI-D connector
USB:	Type B USB input socket USB-A 2.0 High Speed (x2)

35.10.2 Power, Weight and Dimensions

Power:	75W
Weight:	27.2 lbs (12.33 kg)
Dimensions:	20.14" (511.56mm) wide 24.02" (610.05mm) deep 9.62" (244.34mm) high

35.10.3 Performance

Display:	15.6" Diagonal active matrix TFT LCD
Native resolution:	1366 x 768
Input frequency:	31.5 - 80 kHz (H), 56-75 Hz (V)
Contrast ratio:	500:1 (typical)
Viewing angle:	160 x 160 degrees (typical)
Response:	80 ms (typical)
Brightness:	300 cd/m2 (typical)

35.11 Hog 4 PC

Processor:	1.8 GHz Dual Core CPU or faster
Supported Operating Systems:	Windows 10 (32-bit or 64-bit)
Memory:	2GB
Hard Disk Space:	5 GB of free disk space
Screen Resolution:	1024x768 or higher-resolution monitor

Glossary

I

- 10 Base-T An older flavour of Ethernet that is slower (10 MBits per second) than the 100 Base-T used by Hog components. If connected to other equipment that only supports this flavour, then Hog components will automatically detect this, and run their Ethernet connections at this slower speed.
See Also *100 Base-T*.
- 100 Base-T A flavour of Ethernet that supports data rates of up to 100 MBits per second. All Hog components support this flavour of Ethernet, and comply with all relevant standards, so networking equipment designed for 100Base-T should be compatible with the Hog.
See Also *10 Base-T*.

A

- abstraction layer Hog 4 OS separates ('abstracts') the user from the details of how fixtures work. For example, most values are expressed in real world values such as degrees of rotation, rather than DMX values.
- aggregate fixtures when two or more fixtures are assigned dotted user numbers with the same whole number portion (1.1, 1.2, 1.3, etc...)

B

- blocking cue A blocking cue prevents changes made to earlier cues from tracking through to later cues.
See Also *tracking*.
- buddying During fanning, buddying keeps fixtures in 'gangs' that all take the same parameter value.
See Also *fanning*.
- button An on-screen control operated by clicking with the mouse or trackball or touching the screen. In this manual the work "key" is reserved for hardware buttons on the console's front panel.

C

- cell A single rectangle in a spreadsheet, containing a value.
See Also *spreadsheet*.
- chase A series of cues, that run automatically, connected with link and delay attributes.
See Also *cue, cuelist*.

CITP	Controller Interface Transfer Protocol: a protocol used by the Hog 4 OS to supply the media picker with thumbnail previews of content on connected Media Servers See Also <i>media picker</i> .
command keys	User-created single button executers that trigger existing show objects.
command line	A method of entering information into the Programmer, using the numerical keypad and the @ button. See Also <i>programmer</i> .
compound fixture	a single fixture entity that is comprised of one or more fixture parts (sometimes of varying fixture types).
control set	a collection of physical master key mappings. There are five editable control sets: Standard, Intensity, Playback Rate, Effect Rate, and Effect Size
conversion curve	A curve that defines the relationship between the plotted parameter value and the DMX value sent to the dimmer or fixture. Conversion curves are like dimmer curves or profiles on other consoles, and should not be confused with paths. Conversion curves are properties of the fixture, while the path is a property of a cue. See Also <i>path</i> .
crossfade	A transition between two cues, one replacing the other.
cue	A look on stage, achieved through the manipulation of fixture parameters recorded as part of a cue list. A cue requires a trigger, either manual or automatic, and has attributes such as fade, wait and delay times. See Also <i>scene, fade time, wait time, delay time</i> .
cuelist	A group of cues that run in a specific order consecutively, or even simultaneously. These may be automatically linked to form a chase, or manually triggered. A cuelist is run from a master.

D

dbo	dead black out. Pressing the dbo key on the console will set all intensity output to 0% regardless of the position of the grand master fader.
default value	A parameter value which has not been adjusted by the user. This value is assigned by the fixture's Library, and may not always be zero. For example, the default value of Shutter Open/Strobe Off may be Open. See Also <i>touched value, tracking</i> .
delay time	The time the console waits before starting a cue's crossfade. See Also <i>wait time, crossfade, path</i> .

desk channel	Single conventional lights that only have intensity control via a dimmer are defined as desk channels by Hog 4 OS. By contrast, automated lights are referred to as fixtures.
DHCP	Dynamic Host Configuration Protocol is a way for a computer to ask a master computer on a network to assign it an IP address when it connects. Many existing networks are configured this way, and Hog 4 OS supports this system. You should talk to the administrator of the network you want to connect to find out more. See Also <i>ethernet, IP address</i> .
dimmer curve	See <i>conversion curve</i> .
directory	A window which displays palettes, scenes or groups. See Also <i>palette</i> .
DMX	Short for DMX 512, DMX is the communications protocol most commonly used to connect lighting consoles to fixtures and dimmers.
DMX address	A number between 1 and 512 that identifies a controllable parameter of a fixture. Each fixture or group of dimmers has a 'start address', the first of the range of DMX addresses that it uses.
DMX universe	A single DMX output with 512 channels is known as one DMX universe. A Hog network may support many universes each with fixture addresses between 1 and 512. See Also <i>DMX Processor</i> .
dotted user number	A user number for a fixture that contains a whole number and a part number. Example: Desk Channel 1.23 See Also <i>DMX Processor</i> .
DMX Processor	A nineteen inch, rack mounted network node that distributes DMX output. There may be many DMX Processors within a lighting control network. See Also <i>node</i> .

E

editor	A window for editing the contents of cues, scenes, groups or palettes. See Also <i>programmer</i> .
effects engine	The Hog 4 OS effects engine provides the opportunity to create movement sequences. The engine contains library shapes, whilst allowing for custom effects to be created.
encoder wheel	See <i>Parameter Wheel</i> .
ethernet	A defined way of connecting computer equipment together. It comes in a variety of flavours. See Also <i>10 Base-T, 100 Base-T, IP address</i> .

F

- fade time Time in which fixtures crossfade between the parameter levels of two cues - one incoming, one outgoing.
See Also *split fade, in time, out time*.
- fanning A way of quickly assigning fixture parameters to an evenly spaced range of values. For example, you could use fanning to assign the intensity of 10 fixtures to 10%, 20% ... 90%, 100% in a single operation.
See Also *buddying*.
- fixed kind Fixed kinds are the default collections of functions that collectivity contain all of the fixture functions used in your show. There are 7 fixed kinds: Intensity, Position, Colour, Beam, Effects, Time, and Control. The fixed kinds are represented by dedicated front panel buttons and onscreen menus
See Also *kinds*.
- fixture library A separate data file installed into the libraries folder on the console that contains dmx mappings called "fixture types" which provide Hog 4 OS with a model for controlling a fixture's programmable parameters.
See Also *abstraction layer*.
- function See *parameter*.

G

- gamut The range of colours that a fixture is capable of producing. Each fixture type has its own gamut.
- gobo Image placed within the optical system of the fixture, projected onto lit object. Also known as a pattern.
- graphical user interface A way of displaying information, and allowing the user to work with it, in a visual form. Most personal computers use a GUI with windows, buttons and a pointer.
See Also *command keys*.
- group pre-recorded fixture selections, complete with selection order information stored in the group directory. Groups allow the quick selection of multiple fixtures, and, like ordinary fixture selections, can be combined and manipulated in a variety of ways.
- GUI See *graphical user interface*.

H

- hard value The output of a master running a cuelist is a mix of hard and soft parameter values. Hard values are those that are in the current

cue, while soft values are those that have tracked through from previous cues.

See Also *tracking*.

HID Mode A special mode for the console front panel that allows it to be used as a keyboard during a full software install. Pig + Fan+ Up Cursor Key puts the front panel into HID Mode. Pig + Fan+ Down Cursor Key takes the front panel out of HID Mode and puts it back into Hog mode.

See Also *tracking*.

HTP Highest Takes Precedence. In this system of operation, the highest value assigned for a parameter is the one that applies. A fixture can be in cues on two masters, and the highest level of the two will be the one seen. HTP is only relevant to intensity parameters where the idea of 'highest' has meaning.

See Also *LTP*.

hue The colour (pigment) element of colour notation.

See Also *saturation*.

I

I-Wheel The I-Wheel on the right hand side of the console is used to control fixture intensity.

in time The time of the fade up of the incoming cue during a crossfade. All fixtures that are increasing in intensity will come up over this time.

See Also *split fade, path, fade time*.

inhibitive submaster A master that sets a maximum level on a group of fixtures. If the master is at 80%, then the fixtures will never come above 80% in the console's output.

IP address On an Ethernet network, each Hog component has an address, called an IP address, used to identify it. You can usually use the default addresses, but if you are connecting to an existing network you may need to specify a different address, according to how your network is configured.

See Also *ethernet*.

K

key A physical button on the console's front panel. The manual reserves the word "button" for buttons that appear on screen.

kinds Kinds are collections of fixture functions organized into wheelsets. Kinds are stored in the kinds directory and exist in two different forms: fixed kinds and user kinds.

See Also *fixed kind, user kind*.

knockout Knocking out is the process of removing fixtures from the Programmer window, so that they will not be recorded into cues.

L

LTP Latest Takes Precedence. In this system of operation, the most recent instruction to assign the value of a parameter is the one that applies. A cue run on one master can take control of fixtures set by a cue in another master.
See Also *HTP*.

M

maintain state The Hog 4 OS's Maintain State feature eliminates the common problem with tracking, where playing back cues out of order results in incorrect lighting states on stage.
See Also *tracking*.

mask A method of selecting information that is specific to a palette, fixture, cue, scene or group, when recording, making selections, editing, programming, or playing back cues/scenes. For example the fixed function kinds can be used to mask which function kinds (intensity, position, colour and beam) get record into a cue or palette.

master "Master" is a generic term that can be used to refer to any cuelist, scene, or chase in the show. When a cuelist, scene, or chase is assigned to one of the choose keys on the console it is know as a "physical master"; otherwise it is referred to as a "virtual master".
See Also *cuelist*.

master wing A Hog accessory that increases the number of physical masters available on the console by 30.
See Also *master*.

media picker A graphic user interface window that displays selectable thumbnail previews of slotted content for the current fixture selection
See Also *CITP*.

MIDI Musical Instrument Digital Interface. Allows communication of musical notes, programmes and timing data between electronic instruments and other devices such as lighting consoles.
See Also *timecode*.

MIDI Show Control Subset of MIDI used in the entertainment industry for integrated control of lighting, sound and stage automation.

modifier A key that is used in conjunction with other keys or buttons, to change the effect that it has. For example, the Pig key.
See Also *pig key*.

multicast A network protocol or language that computers use to talk to each other over Ethernet. Hog 4 OS uses this standard protocol, which means that it can safely be connected to other networks of computers and will not interfere with them. For show-critical situations you should run Hog system on its own independent network. See Also *ethernet*.

N

net number The number that identifies the console when it is operating as part of a network.

node Network nodes are items of equipment connected to the network. Consoles, DMX Processors and Hog 4 PC systems are all nodes. See Also *DMX Processor*.

O

on stage The output of the console; more specifically, the fixtures that have non-zero intensities.

open sound control (OSC) a protocol for communication among computers, sound synthesizers, and other multimedia devices that is optimized for modern networking technology.

out time The time of the fade of the outgoing cue during a crossfade. All fixtures that are decreasing in intensity will go down over this time. See Also *split fade, path, fade time*.

P

page A preset arrangement of cuelists residing on the masters. Pages can be changed allowing masters to be used by many cuelists.

palette A stored parameter setting, such as position, for one or more fixtures. Fixtures of different make or type may share the same palette. See Also *directory*.

parameter A controllable property of the light produced by a fixture. For example a fresnel has one attribute: intensity. Moving fixtures have pan and tilt parameters and perhaps colour, beam shape, and so on.

Parameter Wheel A wheel that facilitates the control of fixture parameters. Parameter Wheels are fixture sensitive: once loaded from the fixture library, parameters are allocated logically to the wheels.

patch The assignment of DMX addresses to fixtures. See Also *DMX*.

patch point	The set of information that defines where a fixture is patched, including DMX address, DMX universe, and DMX Processor. Some fixtures have multiple patch points. See Also <i>DMX, DMX address, DMX Processor</i> .
path	A way of defining the way that a parameter changes during a fade. You could assign a path that makes the fixture parameter snap to its final value at the start of the fade, for example. Paths should not be confused with conversion curves; paths are the properties of a cue, while a conversion curves is the property of a fixture. See Also <i>fade time, conversion curve</i> .
pig key	The Pig button is a modifier key, and may be used in conjunction with other keys to alter their function.
pile on	A system where new objects are added to previous ones, rather than replacing them. Hog 4 OS can be assigned to pile on desktop views, so that new windows are opened but ones from the previous view are not closed.
pixelMap	rectangular plot objects which can be used to map the pixels of rich media content (photos and videos) onto lighting fixtures through a process known as PixelMapping.
pixelmap Layer	programmable fixtures that are used to send media content to PixelMaps.
playback wing	A Hog accessory that increases the number of physical masters available by 10. See Also <i>master</i> .
plot	a user created graphical layout that contain programable objects such as fixtures and PixelMaps. Plots can be used to select fixtures, gather fixture feedback, and apply PixelMapping values to fixtures.
point cue	A cue who's number contains a decimal point. Point cues are initially given whole numbers, but a point cue can be inserted between two whole number cues. For example, cue 2.5 is a point cue between cues 2 and 3.
port number	On a computer network, the port number defines a particular type of network traffic. In the case of a Hog network, each show running on the network has its own port number, so that a console can identify and connect to a particular show.
programmer	A window where cue and scene data is created or edited. The Programmer takes priority over all commands sent to a fixture elsewhere in the console.

R

rate	The adjusted speed at which a recorded cuelists, scenes, chases, and effects are played. For recorded chases rate is represented in
------	---

beats per minute. For recorded cues, scenes, scenes, and effects rate is represented in percentage. For example, a 2s cue will playback in 4s when the cuelist it is part of has a rate of 50%.

- Rate Wheel The wheel on the left hand side of the Hog 4 console and Hog 4 PC used for adjusting playback and effect rates.
- remainder dim Used after selecting a fixture or group of fixtures, setting all remaining fixtures to a zero intensity level.

S

- saturation The amount of pigment in colour notation.
See Also *hue*.
- scene a single cue stored in the scene directory that has full timing features but does not belong to a cuelist. Scenes can be used to store a single look that may be called back for use in later programming, or to play back many simple looks directly from physical or virtual masters.
See Also *cue, cuelist*.
- selection order The order in which the user selects fixtures into the Programmer or editor. Hog 4 OS remembers this and can apply fanning, or effects according to a fixture's place in the sequence. The sequence is recorded as part of groups and palettes.
See Also *group, palette*.
- show server The Hog console that 'owns' a show. Other consoles may join the show, but the original console that created the show will remain the show server.
- slot A discrete step in a parameter's range, such as the position of a gobo wheel.
- SMPTE A form of time code that can be used to synchronise the operation of various controllers, for example synchronising lighting to video playback.
- Soft Key The Soft Keys are the row of keys above and below the touchscreens. They mimic the function of toolbars docked along the edge of the screens.
See Also *toolbar*.
- soft parameter value See *tracked value*.
- split fade A crossfade where the incoming and outgoing cues have different times, causing an imbalanced or dipped fade profile.
See Also *crossfade, in time, out time*.
- spreadsheet A way of displaying values in a grid. Hog 4 OS editor windows use a spreadsheet to display parameter values.

- suck A console function that will put any values that are "on stage" (in playback from a master) for the selected fixtures into your current active editor.
- switch When you want to connect more than two Hog components together, then you need a special piece of equipment to allow them to interconnect called an Ethernet Hub or Ethernet Switch.
See Also *ethernet*.

T

- TCP/IP A network protocol or language that computers use to talk to each other over Ethernet. Hog 4 OS uses this standard protocol, which means that it can safely be connected to other networks of computers and will not interfere with them. For show-critical situations you should run the Hog system on its own independent network.
See Also *ethernet*.
- toolbar A long, thin window with a series of buttons, that generally sits along the top or bottom edge of the screens. When in this position, a toolbar is said to be 'docked'.
See Also *Soft Key*.
- touch screens The two LCD screens on the console, which display and allow the user to select information from them.
- touched value A parameter value that has been assigned or edited by the user. Values which are not touched will remain at their default value.
See Also *default value, tracking*.
- timecode A method of synchronising the console with other playback sources, such as music, video or film. Hog 4 OS supports MIDI, Linear Timecode and Video Timecode.
See Also *MIDI, SMPTE*.
- timing Cues have several values that control timing: fade, wait, delay and path.
See Also *fade time, wait time, delay time, path*.
- tracked value The output of a master running a cuelist is a mix of hard and tracked parameter values. Hard values are those that are in the current cue, while tracked values are those that have tracked through from previous cues.
See Also *tracking*.
- tracking A method of dealing with cuelists that does not record information in a cue unless it is a change from the previous cue. This allows multiple cuelists to be running at the same time without them interfering with each other.
See Also *hard value, tracked value, touched value, default value*.

U

- UDP A network protocol or language that computers use to talk to each other over Ethernet. Hog 4 OS uses this standard protocol, which means that it can safely be connected to other networks of computers and will not interfere with them. For show-critical situations you should run the Hog system on its own independent network. See Also *ethernet*.
- user kind User kinds are customized kinds built by the user, allowing you to create smaller collections of fixture functions on fewer wheelsets. See Also *kinds*.
- USB Universal Serial Bus: a means of connecting computer peripherals such as keyboards and mice. Hog consoles also use USB to connect expansion wings. See Also *playback wing*.

V

- view An user-defined arrangement of windows that can be accessed with a single button press from the View Toolbar.
- virtual master A playback object (cuelist, scene, batch, or group) that is not attached to a physical master on current page but can still be executed by other means such as the command line or directory window. See Also *cuelist*, *master*.
- visualiser A real-time computer rendering package, that allows the Programmer to create their lighting virtually before getting to the venue.
- virtual user number When more than one dotted user number fixtures share a common whole number, that whole number is considered to be a virtual user number for those fixtures if no other fixtures in the show are assigned to just that pure whole number.

W

- wait time The time between the previous cue being triggered and the current one being run automatically. Not to be confused with the delay time. See Also *delay time*.
- wheelset the building blocks of both fixed kinds and user kinds that specify how fixture functions assigned within a kind are displayed on the console's main encoder wheels when a fixture selection is made. See Also *kinds*.
- white point A definition of white light used by Hog 4 OS's colour calibration system to match the colour of fixtures with different lamp types, such as tungsten and arc.

widget A device that allows the connection of accessories to the console or PC via USB. Such accessories may range from input control panels to DMX outputs.
See Also *USB*.

Z

zoom Allows the size of beam/ image to be adjusted whilst maintaining its focus.

Symbols

@ key, 157

A

abstraction, 28
accessories, 59
action of go when looping, 306
aggregating fixtures, 121
aggregation

- collapsing sections, 41
- jumping between sections, 42
- section priority, 42
- spreadsheets, 40

all button, 153
allow refs button

- when recording palettes, 190

apply patch, 122
arrow keys (see keys, cursor)
art-net, 78
art-net input, 413
assert, 307
assert time, 308
auto kinds, 272
auto launch;, 92
auto palettes, 136
auto release, 301
auto update, 283
auto-patch, 145
autofocus, 449

B

back button, 219
back key, 153
back time, 304
background images

- adding, removing, editing background images, 354

backlight off time, 62

- console touch screens, 53

backup, 95
backwards button, 219
batches, 331
beacon, 82
beam

- modifying values, 160–161

blind mode, 285
blocking, 222

- removing blocking, 223

boot server, 65
brightness

- desklights, 96
- touch screens, 52

buddying, with fanning, 173
bugs

- reporting, 484

burning a CD, 48
button, 18

C

calibration

- colour, 32, 164

calibration of touch screens, 52
capture activity, 338
CD drive

- creating a CD, 48
- ejecting a disk, 48

center wheel, 99, 156
chases

- setting rate with Tap Sync, 325
- using cuelist as, 323

chat, 115
CITP, 204
cleaning

- faders, 488

client, 70
clock, 21

- display format, 51

clock toolbar, 253
clock triggers, 251
clock, console, 51
clone (see copying fixture parameter values)
cloning patching, 129–130
CMY, 31, 162
collapse aggregated sections, 41
colour

- modifying values, 160–161

colour calibration, 32, 164
colour coding, 35
colour models, 31, 162
colour picker, 32, 164
colour scheme, 52
colour temperature, 32
command keys, 345

- changing what happens when a command key is pressed, 346
- copy, move, delete, 346
- creating, 345

- feedback, 347
- command line, 21
 - syntax, 19
- comment macro (see macro)
- compact mode (spreadsheets), 39
- compound fixtures, 121
- compress show, 96
- console
 - locking the console, 57
 - reporting problems, 485
- console fail over, 70
- console tracking, 74
- control panel
 - console date and time, 51
 - displays, 53
 - keyboard, 55–56
 - network settings, 91
 - system info, 485
- copy, 43
- copying
 - cuelists, 230
 - cuelists to pages, 340
 - cues, 216
 - effects, 269
 - fixture parameter values, 168
 - fixtures, 134
 - group masters to pages, 340
 - groups, 180
 - pages, 341
 - palettes, 184
 - parameter values into an editor, 281
 - scenes, 234
 - scenes to pages, 340
 - shows, 47
 - user kinds, 273
- creating
 - effects, 261
 - pages, 335
- creation date, 47
- cross-fade
 - manual, 321
- cue only, 326
- cue list
 - exporting, 108
 - importing, 108
- cue list directory, 33
- cue lists, 228
 - copying, 230
 - copying to pages, 340
 - cue only, 306
 - deleting, 229
 - effect rate, 319
 - effect size, 320
 - feedback, 314
 - IPCB fader mode, 322
 - moving, 230
 - moving to pages, 340
 - naming, 229
 - ordering of cues, 254
 - pages, 335
 - playback, 289
 - playback rate, 319
 - removing from pages, 340
 - renumbering, 217
 - status, 312
 - using as a chase, 323
 - wrapping, 305
- cues
 - clock triggers, 251
 - copying, 216
 - deleting, 215
 - editing contents, 218
 - editing parameter timings, 243
 - editing times, 241
 - follow-on, 249
 - learn timing, 250
 - linking, 254
 - looping, 254
 - manual, 249
 - moving, 217
 - naming, 214
 - numbering, 214
 - ordering, 254
 - paths, 240
 - recording, 213
 - removing parameter values, 215
 - with a delay time, 240
 - with a fade time, 238
 - with selected fixtures only, 215
 - with state, 222
 - timing, 237
 - tracking backwards when recording, 219
 - tracking forwards when deleting, 222
 - tracking forwards when inserting, 220
 - triggering, 249
 - triggering from timecode, 379, 396
 - wait time, 249
- cursor keys, 117
- cut, 43

D

- date
 - creation, of a show file, 47
 - format, 51
 - setting the console clock, 51
 - dbo
 - disable, 328
 - dbo key, 328
 - default value of parameters, 143
 - delay button, 43
 - delay time, 237, 240
 - fanned, 248
 - deleting
 - cuelists, 229
 - cues, 215
 - desktop views, 27
 - effects, 269
 - fixtures from groups, 178
 - groups, 179
 - link cues, 254
 - pages, 341
 - palettes, 184
 - scenes, 234
 - shows, 47
 - user kinds, 272
 - deselecting fixtures, 155
 - desk channels, 28, 117
 - desklights, 96
 - desktop views, 25
 - deleting, 27
 - naming, 26
 - options, 27
 - recalling, 26
 - recording, 26
 - DHCP server, 60, 65–66
 - diagrams
 - front panel, 479
 - direct palettes, 33, 190
 - directories, 33
 - automatic naming of items, 35
 - colour coding items, 36
 - default item names, 35
 - directory windows, 193
 - button sizes, 196
 - buttons across, 198
 - color coding, 194
 - color coding entire button, 195
 - list view, 200
 - show auto color swatch, 199
 - show fewer buttons, 197
 - write permissions, 193
 - discrete parameter values (see slots)
 - displays, 52
 - dmx address, 28
 - dmx highlight, 415
 - dmx processor, 63
 - adding for patching, 127
 - cloning, 130
 - dmx refresh rate, 61
 - full install, 457
 - IP address, 60
 - locking the controls, 61
 - mains power, 59
 - net number, 60
 - port number, 60
 - removing, 127
 - reset options, 478
 - resetting, 62
 - status, 62
 - updating software, 456
 - using, 59
 - watchdog, 62
 - dmx processor 8000
 - technical specifications, 504
 - dmx refresh rate settings
 - dmx processor, 61
 - dmx test, 413
 - dmx widgets, 86
 - Status LEDs, 87
 - upgrading, 463
 - dotted user numbers, 121
- ## E
- edit button, 45
 - edit fixtures window, 141
 - editing
 - cue contents, 218
 - cue timings, 241
 - effects, 261, 269
 - group contents, 178
 - palette contents, 182
 - parameter timings in cues, 243
 - scene contents, 235
 - editor toolbar, 44
 - editor values toolbar, 44
 - editors, 43
 - bringing in values from onstage, 278
 - clearing the contents of, 175

- locking, 45
 - which is the current editor?, 21
 - effect directory, 33
 - effects, 257
 - copying, 269
 - deleting, 269
 - editing, 261, 269
 - engine, 261
 - fanning, 261
 - length, 258
 - moving, 269
 - n-shot, 258
 - naming, 268
 - offset, 258
 - palettes, 267
 - predefined, 266
 - rate, 258
 - size, 258
 - spread, 264
 - tables, 257
 - timing, 265
 - using in programming, 268
 - embedded palettes, 181
 - enable aggregation, 40
 - enable jump toolbar, 42
 - enable timecode, 379, 396
 - encoder wheel
 - encoder wheel button
 - options, 101
 - endstops of parameter values, 161
 - ETCnomad Key, 88–89, 484
 - Ethernet, 63
 - even button, 153
 - export
 - preferences, 96
 - external
 - keyboard, 55–56
 - external displays, 53
- F**
- fade button, 43
 - fade changes, 285
 - fade time, 237–238
 - default, 238
 - with masks, 239
 - faders
 - cleaning, 488
 - replacing, 487
 - fanning, 170, 248
 - effects, 261
 - fanning toolbar, 172
 - from the command line, 171
 - in spreadsheet view, 171
 - multi-part, 173
 - options, 172
 - with segments, 173
 - with the fan key, 171
 - feedback
 - cuelist, 314
 - file browser, 47
 - files
 - sharing over a network, 76
 - fine control of parameter values, 166
 - firewalls, 66
 - fixed kinds, 271
 - fixture builder, 420
 - terminology and concepts, 427
 - fixture library
 - fixture builder, 420
 - install, 419
 - request, 420
 - fixture schedule window, 117
 - fixture types, 102
 - fixture window, 138
 - FixtureNet, 78
 - IP Address, 79
 - fixtures, 28
 - adding, 117
 - changing type, 135
 - cloning patching, 129–130
 - configuring, 138
 - copying, 134
 - copying parameter values, 168
 - deselecting, 155
 - duplicating, 114
 - exporting, 112
 - fixture library, 419
 - generic, 117
 - importing, 112
 - interchangeable, 29
 - inverting pan and tilt, 140
 - inverting the selection, 153
 - lateral selections, 154
 - modes, 117
 - notes, 138
 - patch notes, 139
 - patching, 122
 - proportional patch, 140
 - protocol, 138

- removing, 136
- removing from an editor, 175
- replicating, 134
- reselecting, 155
- select all, 153
- selecting, 147
- selecting from what is onstage, 277
- selection order, 156
- sub selections, 153
- swapping axes, 140
- timing, 243
- type, 138
- unpatching, 131
- user number, 118–119

flash button

- flash level, 293
- go on flash, 293
- latching, 293
- release on off, 293
- solo, 293

flip, 159

follow chosen, 315

follow cue, 315

follow current, 219

follow next, 219

follow-on, 249

follow-on time, 237

forward button, 220, 222

front panel diagrams, 479

G

Gadget II, 88–89

generic fixtures, 117

global

- palettes, 185

global button

- when recording palettes, 185

glossary, 18, 509

gm key, 327

gobo

- reversing rotation, 161

grand master, 327

- dbo Key, 328
- flash key, 329
- gm key, 327

graphical user interface, 21, 471

group directory, 33

group masters, 329

- copying to pages, 340

- moving to pages, 340
- removing from pages, 340

groups, 177

- auto-generate, 177
- copying, 180
- creating automatically, 136
- deleting, 179
- editing contents, 178
- moving, 180
- naming, 178
- recording, 177
- removing fixtures, 178
- using, 178

guard button, 33, 43, 297

H

halt, 249

- action of halt when halted, 306

hard command (see hard value)

hard values, 29, 166, 222

HedgeHog 4 Console;

- upgrading model, 459

help

- getting started, 17
- key to this manual, 18

help button, 33, 43

highlight, 281

- customising, 282

highlight palette, 33

Hog 4 Consoles

- Making A Bootable USB Flash Drive, 454–455
- technical specifications, 497–503

Hog 4 PC, 89, 467

- interface, 471
- removing software, 470
- system requirements, 507
- upgrading widgets, 463
- windows, 471–472

Hog consoles

- reporting problems, 485

Hog-net, 66

hold over if active;, 336

HSI, 31

HTP, 30, 311

hue, 31, 162

I

i-Wheel, 158

ignore MSC in;, 369

- import
 - preferences, 96
- inhibitive group masters, 329
- insert button
 - with cuelists, 231
 - with cues, 214
 - with groups, 180
 - with palettes, 191
 - with scenes, 235
- install
 - fixture library, 419
- installing software, 451
- intensity, 31
 - modifying values, 157
- interface (see graphical user interface)
- inverting pan and tilt, 140
- inverting parameter values, 161
- inverting the fixture selection, 153
- IP address, 65–66
 - dmx processor, 60
 - with Art-net, 79
- IPCB fader mode (with cuelists), 322

J

- jump points
 - in timecode, 380, 397
- jump toolbar, 42, 45

K

- key, 18
 - double press time, 101
 - repeat delay, 101
 - repeat period, 101
- keyboard
 - external, 55–56
 - on-screen, 55
 - shortcuts, 473
- keys
 - @, 157
 - back, 153, 219, 290
 - blind, 285
 - choose, 290
 - combinations, 475
 - cursor, 117
 - dbo, 328
 - effect, 261
 - fan, 171
 - flash, 290
 - go, 290

- halt, 290
- highlight, 281
- live, 277, 279
- meaning of LEDs, 312
- modifier, 46
- next, 153, 219
- next page, 336
- nudge up and nudge down, 158
- open, 22
- Pig (see Pig key)
- pig, 167, 286
- release, 300
- set, 55
- skip back, 292
- skip forward, 292
- Time, 244
- trackball, 97
- update, 45, 283
- killing processes, 483
- kinds, 271
 - fixed kinds, 271
 - user kinds, 271
- knockout button, 175

L

- lateral selections of fixtures, 154
- launch existing show, 91
 - automatically, 92
- launch macros, 94
- launch new show, 91
- learn timing, 250
- leave in background, 336
 - matching master levels, 338
- levels view window, 317
- library
 - merged status, 47
 - merging, 102
- linear timecode (see timecode)
- link cues, 254
- links (see link cues)
- live key, 277, 279
- locking
 - console, 57
 - dmx processor, 61
- logging off, 56
- loops, 254
 - action of go key, 254
 - tracking through, 256
- lower priority, 42

lowlight, 283

lowlight palette, 33

LTP, 30, 307

M

macro

- command syntax, 399

- when changing pages, 338

- when cues run, 326

- when launching a show, 94

maintain state, 256

maintenance, 487

manual

- cross-fade, 321

manual cues, 249

mark cues, 224

mask

- syntax, 19

- when recording effect palettes, 267

- when recording palettes, 187

masking

- playback, 327

- when recording fade times, 239

master

- default rate, 304

- playback options, 303

master wing 4

- technical specifications, 506

masters

- attaching, 289

- choosen, 299

- grand master, 327

- pages, 335

- physical, 289

- selected, 299

- virtual, 289, 297

- which is the currently chosen master?, 21

matching Levels, 338

media picker, 203

- adding custom images and names to previews, 209

- catalyst, 207

- CITP, 204

- media preview package management, 210

- options, 203–204

- updating older show files with library

- defined previews, 209

merge button

- with cuelists, 231

- with cues, 214

- with groups, 180

- with palettes, 191

- with scenes, 235

merging shows, 102

MIDI, 367

- Midi Note Input, 369

- Midi Note Output, 376

- midi show control, 367

- MIDI timecode, 378

modifier keys, 46

monitor (see display)

mounting, 59

move in black (mark cues), 224

moving

- cuelists, 230

- cuelists to pages, 340

- cues, 217

- effects, 269

- group masters to pages, 340

- groups, 180

- pages, 341

- palettes, 184

- scenes, 234

- scenes to pages, 340

- shows, 47

- user kinds, 273

multiple

- patch points, 127

- shows on the network, 75

multiple consoles, 69

N

naming

- cuelists, 229

- cues, 214

- desktop views, 26

- effects, 268

- groups, 178

- palettes, 181

- scenes, 233

- shows, 47

- slots, 144

net number, 60, 68, 127

network, 63, 66

- boot server, 65

- client, 70

- connecting to an existing, 76

- console fail over, 70

- console tracking, 74
- DHCP server, 65–66
- dmx processor status, 62
- dmx processors, 66
- file sharing, 76
- firewalls, 66
- IP address, 66
- multiple consoles, 69
- net number, 68
- port number, 68, 75
- show server, 69–70
- using art-net, 78
- network adapter, 64
 - IP address, 65
- new
 - show, 91
- next button, 219
- next key, 153
- next page key, 336
- nudge up and nudge down keys, 158
- numbering
 - cues, 214
 - (see also renumbering)

O

- odd button, 153
- on-screen keyboard, 55
- open key, 22
- OSC (open sound control), 383
 - input configuration, 383
 - mappings, 385
 - output configuration, 384
- output window, 315

P

- pages, 335
 - changing, 336
 - clearing, 341
 - copying, 341
 - copying cuelists to, 340
 - copying group masters to, 340
 - copying scenes to, 340
 - creating, 335
 - deleting, 341
 - moving, 341
 - moving cuelists to, 340
 - moving group masters to, 340
 - moving scenes to, 340
 - removing cuelists from, 340
 - removing group masters from, 340
 - removing scenes from, 340
 - template, 342
 - which is the current page?, 21
- palette directory, 33
- palettes, 33, 181
 - automatic naming, 35
 - copying, 184
 - creating automatically, 136
 - default names, 35
 - deleting, 184
 - direct, 190
 - editing contents, 182
 - effect, 267
 - global, 185
 - moving, 184
 - naming, 181
 - recording, 181
 - recording with masking, 187
 - recording with timings, 189
 - reference, 190
 - showing references to in editors, 43
 - types of content, 185
 - using in programming, 182
- pan (see position)
- parameter defaults, 300
- parameter types
 - removing from an editor, 175
- parameter wheels, 159–160
 - center wheel, 99
- parameters, 28, 156
 - default value, 143
 - default values - restoring, 170
 - making non-releasable, 144
 - minimum and maximum values, 143
 - modifying values, 156
 - naming slot values, 144
 - offset value, 144
 - removing value from an editor, 175
 - separating, 176
 - timing, 243
- park editor window, 286
- parking, 286
- paste, 43
- patch
 - exporting, 112
 - importing, 112
 - proportional, 140
- patch points, multiple, 127
- patching, 122

- adding DPs, 127
 - auto-patch, 145
 - cloning, 129–130
 - finding unused addresses, 126
 - fixtures to multiple addresses, 125
 - multiple patch points, 127
 - removing DPs, 127
 - several fixtures at once, 124
 - unpatching, 131
 - with gaps, 125–126
 - path button, 43
 - paths, 237, 240
 - per fixture button
 - when recording palettes, 185
 - per fixture type button
 - when recording palettes, 185
 - persist on override, 310
 - pig key, 46, 167
 - for copy and paste, 43
 - for fine control of parameter values, 166
 - to unpark parameters, 286
 - when using desktop views, 26
 - when using directories, 33
 - with the i-Wheel, 158
 - pile-add effects, 308
 - pixelmapping, 360
 - adding, removing, editing pixelmaps, 353
 - choosing and optimizing content, 364
 - effects, 362
 - importing custom content, 363
 - managing content, 363
 - PixelMaps layers, 360
 - programming PixelMap layers, 362
 - supported file types, 364
 - using PixelMaps in programming, 361
 - playback (see masking)
 - batches, 331
 - cuelists, 289
 - priority, 307
 - using pages, 335
 - playback bar, 312, 338
 - displaying, 82
 - Playback Mask, 327
 - playback priority, 309
 - playback wing, 314
 - adding, 82
 - playback wing 4
 - technical specification, 505
 - plots, 349, 360
 - adding, removing, editing background images, 354
 - adding, removing, editing fixtures, 351
 - adding, removing, editing pixelmaps, 353
 - creating new, 350
 - editing, 351
 - editing multiple objects, 357
 - feedback, 359
 - removing, editing gangs, 352
 - selecting fixtures, 358
 - using, 358
 - window navigation, 359
 - point cues, 214
 - pointer mode (see trackball)
 - port number, 68, 75, 91
 - dmx processor, 60
 - position
 - flip, 159
 - modifying values, 159
 - position mode (see trackball)
 - preferences
 - appearance, 51
 - loading and saving, 96
 - users, 114
 - prev button, 153
 - priority of aggregated sections, 42
 - priority of cuelists, 309
 - problems
 - reporting, 484
 - solving, 481
 - processes
 - restarting, 483
 - programmer, 43, 147
 - bringing in values from onstage, 278
 - clearing the contents of, 175
 - contents after recording, 213
 - proportional patch, 140
 - protocol
 - of fixtures, 138
- ## Q
- qualifier, 427
 - quit, 56
- ## R
- radios
 - personal - use near the console, 484
 - raise priority, 42
 - Rate Wheel, 319

- real world units, 28
 - record options toolbar
 - with cuelists, 231
 - with cues, 214
 - with groups, 180
 - with palettes, 191
 - with scenes, 235
 - Record Options Toolbar
 - with effect palettes, 267
 - record options toolbar;, 188
 - recording
 - CDs, 48
 - cues, 213
 - removing parameter values, 215
 - with a delay time, 240
 - with a fade time, 238
 - with selected fixtures only, 215
 - with state, 222
 - desktop views, 26
 - direct palettes, 190
 - effect palettes, 267
 - effects, 261
 - groups, 177
 - link cues, 254
 - pages, 335
 - palettes, 181
 - parameter timings, 243
 - scenes, 233
 - reference palettes, 190
 - release all, 336
 - release cue, 301
 - release key, 300
 - Release on Other Go, 303
 - release time, 300
 - releasing parameters, 144
 - remainder dim button, 158
 - remember fader values, 336
 - renaming
 - shows, 47
 - renumbering
 - cuelists, 217
 - reorder button, 156
 - replace button
 - with cuelists, 231
 - with cues, 214
 - with groups, 180
 - with palettes, 191
 - with scenes, 235
 - replacing
 - faders, 487
 - touch screens, 487
 - trackball, 490
 - replicating fixtures, 134
 - reporting, 417
 - reselecting fixtures, 155
 - restarting, 56
 - processes, 483
 - restore activity, 338
 - restoring default parameters values, 170
 - reverse button, 156
 - RGB, 31
 - RGB colour, 162
- ## S
- safety information, 491
 - saturation, 31, 162
 - scene directory, 33
 - scenes, 233
 - copying, 234
 - copying to pages, 340
 - deleting, 234
 - editing contents, 235
 - effect size, 320
 - moving, 234
 - moving to pages, 340
 - naming, 233
 - recording, 233
 - removing from pages, 340
 - timing, 235
 - scrolling window contents, 25
 - segments (see fanning)
 - segments, with fanning, 173
 - select all, 153
 - select toolbar, 153
 - selecting fixtures, 147
 - from what is onstage, 277
 - selection order, 177
 - selection order, the, 156
 - separating parameters, 176
 - servicing, 487
 - set key, 55
 - show
 - connecting to a running, 91
 - launch automatically, 92
 - launching an existing, 91
 - show file recovery, 94
 - show manager, 93
 - show palettes button, 43
 - show server, 69–70, 91

- shows
 - backing up, 95
 - changing current, 92
 - compress show, 96
 - copying, 47
 - creation date, 47
 - deleting, 47
 - managing, 93
 - merging, 102
 - moving, 47
 - multiple, on the network, 75
 - naming, 47
 - renaming, 47
 - updating fixture types, 102
 - users, 114
 - shuffle button, 156
 - shutting down, 56
 - skip back key, 292
 - skip forward key, 292
 - slots, 161
 - naming, 144
 - SMPTE (see timecode)
 - soft patching, 125
 - software
 - updating, 451
 - version numbering, 486
 - source button, 43
 - specifications, 497
 - split times, 239
 - spreadsheets, 37
 - aggregation, 40
 - compact mode, 39
 - start window, 91
 - starting up, 91
 - startup macros, 94
 - state button, 222
 - status bar, 21
 - sub selections of fixtures, 153
 - Suck button, 278
 - suppress MSC out;, 369
 - swapping axes, 140
 - switching off the console (see shutting down)
 - symbols, 18
 - syntax, 19
- T**
- tables
 - effects, 257
 - tap sync, 325
 - technical specifications, 497
 - technical support, 481
 - template page, 342
 - template pages, 33
 - theatre
 - lighting consoles, 30
 - tilt (see position)
 - time
 - format, 51
 - setting the console clock, 51
 - timecode, 249, 367
 - editing values, 380, 397
 - jump points, 380, 397
 - simulating, 380, 397
 - triggering cues, 379, 396
 - viewing, 378, 395
 - timing, 237
 - effects, 265
 - fanned, 248
 - scenes, 235
 - toggling scenes, 236
 - toolbars
 - clock, 253
 - editor toolbar, 44
 - editor values toolbar, 44
 - fanning toolbar, 172
 - fanning toolbar;, 156
 - jump toolbar, 45
 - playback bar, 312, 338
 - record options toolbar, 188
 - with cuelists, 231
 - with cues, 214
 - with groups, 180
 - with palettes, 191
 - with scenes, 235
 - Record Options Toolbar
 - with effect palettes, 267
 - select toolbar, 153
 - Slot Toolbar, 144
 - status bar, 21
 - view toolbar, 25
 - window control toolbar, 23
 - touch screens
 - backlight off time, 53
 - brightness, 52
 - calibration, 52
 - replacing, 487
 - touched values, 213
 - touching parameter, 166
 - touching parameters

- with live, 279
- with pig, 167
- touchscreen
 - brightness, 97
- touchscreens, 53
- track backwards, 219
- track forwards, 220, 222
- track through, 166
- track through loops, 326
- trackball, 159
 - keys, 97
 - modes, 97
 - replacing, 490
 - ring, 97
 - using for pan and tilt, 159
 - which is the current mode?, 21
- tracked value, 29
- tracking, 29, 166, 176, 222
 - cue only, 326
 - mark cues, 224
 - stopping values tracking forwards, 220, 222
 - through loops, 256
 - track through loops, 326
 - tracking backwards, 219
- trigger forwards only, 379, 396
- trigger macro, 326
- triggers, 249
- turning off the console (see shutting down)
- type
 - of fixtures, 138

U

- unblock button, 223
- unblocking, 223
- undo, 46
- units
 - real world, 28
- universe
 - cloning, 129
 - unpatching, 132
- unpatching, 131
 - by DMX address, 132
- unused channel, 427
- update key, 45
 - auto update, 283
- updating
 - fixture types, 102
 - software, 451
- USB Flash Drive

- Making A Bootable USB Flash Drive, 454
- Making A Bootable USB Flash Drive on Windows, 455
- user interface, 21
- user kinds, 271
 - auto kinds, 272
 - copying, 273
 - creating new, 272
 - deleting, 272
 - moving, 273
- user manual
 - reporting problems, 486
- user number
 - modifying, 118–119
- user preferences
 - center wheel, 99
 - console, 52–53, 55–56, 96–97, 101
 - edit, 158, 176, 238
 - playback defaults, 164, 336
- users, 114

V

- value button, 43
- version numbering, software, 486
- video timecode (see timecode)
- view by DP, 126
- view cue, 219
- view toolbar, 25
- views (see desktop views)
- views directory, 25, 33
- virtual masters, 297
- virtual wing, 84
- visualizer
 - autofocus, 449
- visualizers, 437

W

- wait time, 237, 249
- wheelsets, 274
- white point, 32, 164
- windows
 - closing, 23
 - cue list, 228
 - directory, 33
 - edit fixtures, 141
 - editor, 43
 - fixture schedule, 117
 - fixture window, 138
 - launched processes, 483

Index

- levels view, 317
- on Hog 4 PC, 471–472
- opening, 22
- output, 315
- park editor, 286
- scrolling contents, 25
- show manager, 93
- spreadsheets, 37
- view by DP view, 126
- window control toolbar, 23
- wings
 - adding playback wing, 82
 - playback, 314

X

- XML Export, 427
- XML Import, 427

